



On-line Partial Discharge (OLPD) Monitoring of Complete High Voltage (HV) Networks in the Oil & Gas Industry

October 2014

Presented by:
Dr Lee Renforth,
Managing Director
HVPD Ltd

PROGRAMME

1. On-line Partial Discharge (OLPD) Testing and Monitoring of Rotating High Voltage (HV) Machines in the Oil & Gas Industry
2. ***On-line vs Off-line*** Partial Discharge Testing of Line-Fed HV Motors and Generators
3. Remote OLPD monitoring of ***Ex/ATEX HV motors*** using wideband HFCT sensors at the central switchboards
4. OLPD Testing and Monitoring of ***Variable Speed Drive (VSD)*** HV Motors
5. ***Case Studies*** from HVPD's recent OLPD Test and Monitoring Projects in the Worldwide Oil & Gas Industry



PRESENTATION I

On-line Partial Discharge (OLPD) Monitoring of Complete High Voltage (HV) Networks in the Oil & Gas Industry





PRESENTATION I - CONTENTS

- Introduction to HVPD Ltd
- Introduction to Partial Discharge (PD)
- On-line Partial Discharge (OLPD) sensors for rotating high voltage (HV) machines and complete HV networks
- Remote OLPD monitoring of line-fed Ex/ATEX HV motors and other plant from the central switchboards
- HV network OLPD monitoring database user interface options



- HVPD are experts in the field of on-line partial discharge (OLPD) technology and now have over 20 years of experience in the OLPD testing of in-service high voltage (HV) cables, switchgear, transformers and motors/generators.
- We supply portable and permanent OLPD diagnostic test and continuous OLPD monitoring solutions, and a complimentary range of on-site services, training and monitoring services.
- We have Five (5) main market sectors: Oil & Gas, Renewables, Transmission & Distribution, Shipping and Generation.



Oil & Gas

We specialise in onshore and offshore central remote on-line partial discharge monitoring and testing in Ex zones. Main projects include testing and monitoring of:

- Motors and generators
- Cables and cable accessories
- Switchgear
- Power Transformers

Operators:



bp



ExxonMobil

DOLPHIN ENERGY / دولفين للطاقة

OEM:

SIEMENS

Schneider Electric







What is partial discharge?

“A **localised** electrical discharge that only partially bridges the insulation between conductors and which can or can not occur adjacent to a conductor”
IEC60270 Definition



Why test for partial discharge?

PD activity is an indication of an **‘incipient fault’** in HV insulation and is widely regarded as the best **‘early warning’** indicator of the deterioration of high voltage insulation.



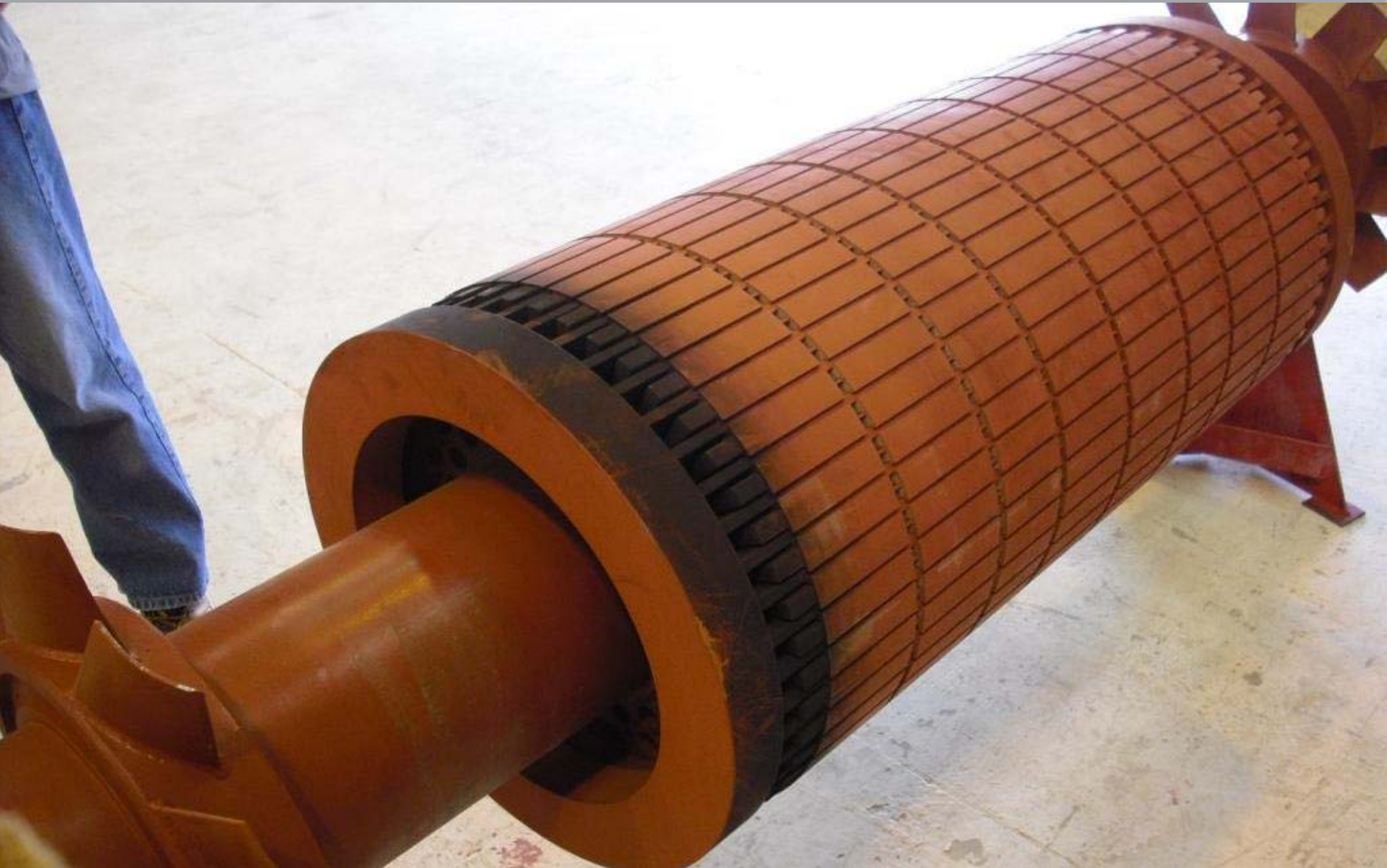



ON-LINE PARTIAL DISCHARGE



- OLPD testing refers to the testing of ***in-service*** high voltage (HV) cables and plant (including both static and rotating plant).
- The OLPD technique detects, locates and monitors partial discharge activity within the HV plant insulation, ***without the need to de-energise the plant.***
- The assessment of the health of HV network can thus be made with ***minimal disruption to operations and cost.***
- Equipment is tested under ***both normal (and abnormal) working conditions***, 24 hours per day, 365 days a year.
- OLPD diagnostics are an essential tool for the effective implementation of ***condition-based maintenance (CBM)*** techniques within HV power networks.

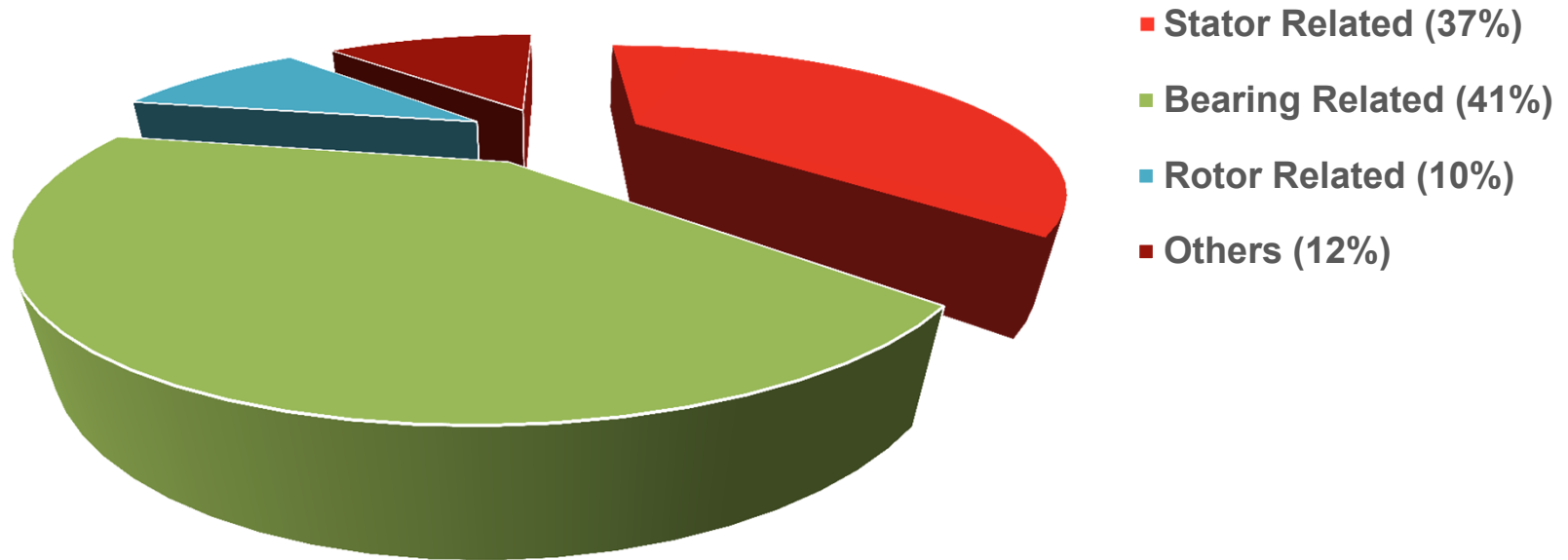

- 41% of failures occur due to **mechanical** issues (vibration or bearings)
- **37% of failures** are electrical, from **high voltage stator winding failures**
- 10% are **rotor-related** failures
- These three causes cover around **90% of all HV motor failures**.
- **On-line Partial Discharge (OLPD)** techniques are used to detect **electrical deterioration** of the high voltage stator windings insulation prior to failure.

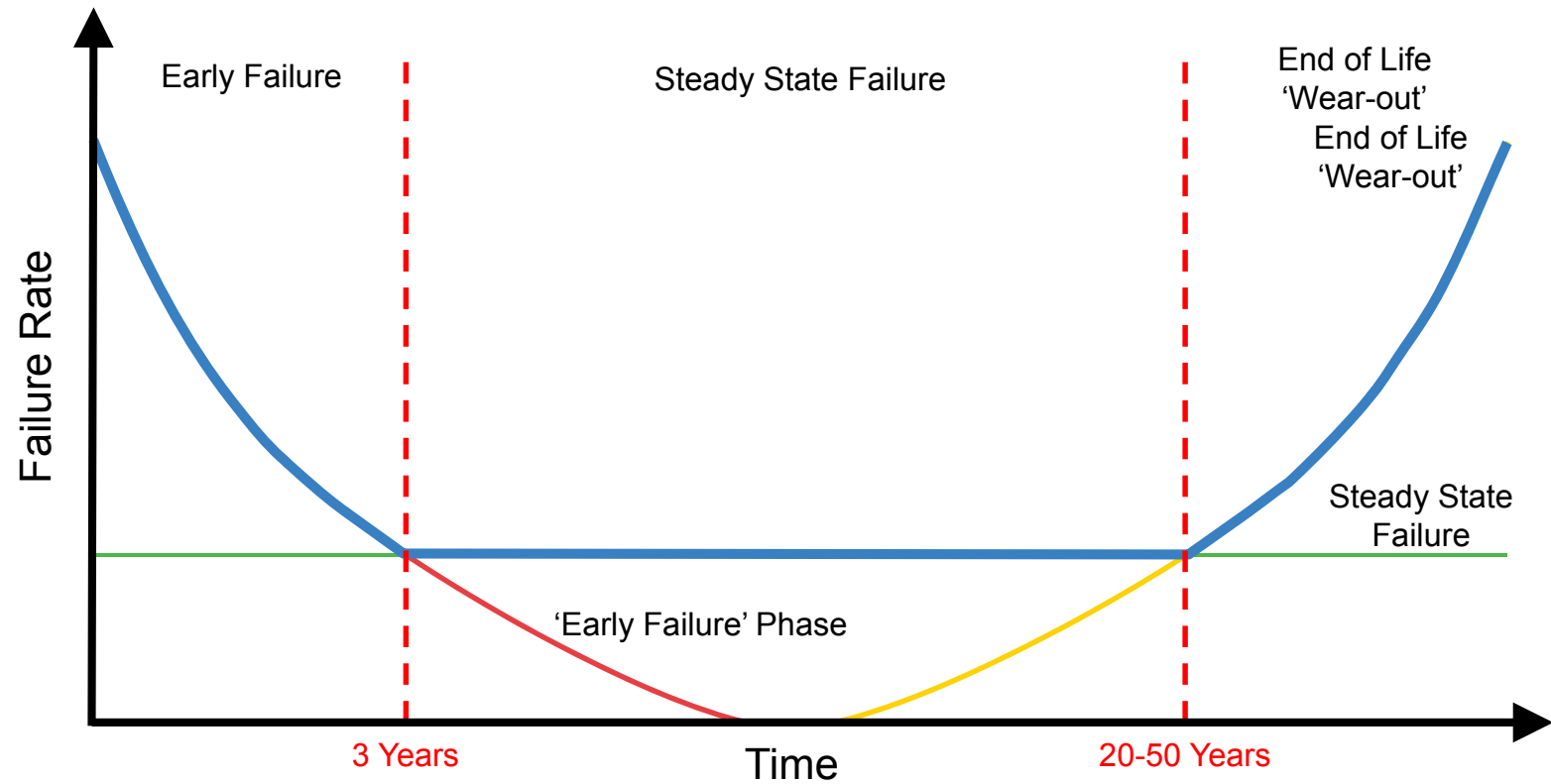

Time-Based Maintenance and Replacement

- The oldest is in the worst condition?
- What is the rotating HV machines' historical service record, total hours of service and maintenance history?

Reactive Maintenance

- Assess similar/nearby plant only after a failure.

Condition-Based Maintenance (CBM)

- Assess the health of plant routinely and/or continuously and then perform maintenance only on plant in the worst condition (the 'worst 5%').

- **High Voltage (HV) Ex/ATEX Motors**, like all other types of rotating HV machines, are prone to breakdowns and failures caused by **both electrical and mechanical** ‘wear and tear’.
- Breakdowns and failures of the rotating HV machines are therefore inevitable with time in service, it is just a matter of time!
- Many of the breakdowns can be avoided through the implementation of **Condition-Based Management (CBM)** using **condition monitoring (CM)** technology to support preventative maintenance interventions.
- It is through the detection of **‘incipient’ failure mechanisms** and developing faults before they occur (using CM assessment and trending) that in-service failures and unplanned outages can be avoided.
- To provide a complete ‘picture’ of the health of a rotating HV machine it is therefore necessary to apply a **combination of both electrical and mechanical CM technologies**.

The partial discharge (PD) insulation diagnostic techniques enable a ***continuous evaluation of a rotating HV machine's dielectric integrity throughout its service life.***

1. **Off-line Factory PD testing** should be carried out after manufacture, at the machine manufacturer's facility. Off-line PD testing should also be carried out ***at commissioning*** to provide 'baseline' PD measurements.
2. **Frequent OLPD testing** and/or continuous OLPD monitoring should be carried out throughout the critical, ***first 3 years of service*** – the '***infant mortality***' or '***bedding in***' period of the machine.
3. **OLPD testing and monitoring** should be carried out ***after any repair*** and/or rewind is made to the machine – to ensure the repair has worked!
4. **Regular OLPD testing/monitoring** is required throughout the service life of the machine with particular focus on those machines that are reaching the ***end of their predicted 'design life'*** (typically of 20 years).

THERMAL

Loading / duty cycle thermo-mechanical effects and variations.



ELECTRICAL

Localised electrical stresses at the end windings and voids or delaminations in groundwall insulation.



AMBIENT

Temperature and relative humidity, surface discharges can occur with high humidity.



MECHANICAL

Wedge tightness, rotor alignment/concentricity, vibration effects, short-circuit fault forces.



To take into account these variable stresses, **continuous electrical and mechanical condition monitoring (CM)** of rotating HV machines is now becoming more widely applied in the worldwide oil and gas (O&G) industry.



ON-LINE PARTIAL DISCHARGE (OLPD) SENSORS FOR ROTATING HIGH VOLTAGE (HV) MACHINES



There are three (3) main OLPD sensor options for rotating HV machines



High Voltage Coupling Capacitor (HVCC)



- 80 pF / 500 pF / 1 nF rating
- **High sensitivity** (when installed in the machine's cable terminal box).
- The higher the capacitance, the better lower frequency response (to sub-10 MHz) to enable detection of PD deep into the HV windings.

High Frequency Current Transformers (HFCT)

- Available in a range of sizes to fit most confined spaces.
- Ex/Atex-certified, saturation currents of up to 1000 A.
- **High sensitivity at low frequencies** and capable of detecting PD in the machine **remotely** with the sensor installed at the switchgear.

Rogowski Coil Sensors (RC)

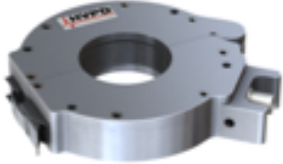
- Does not saturate with high current (>5000 A).
- Ex/Atex-certified (for use in hazardous gas zones).
- **Very low sensitivity** and thus does not detect low levels of PD i.e. only significant PD activity can be detected.

Sensor	PD Sensor Options		
	Picture	Coupling Method	Relative Sensitivity at 10MHz
High Voltage Coupling Capacitor		Capacitive	100
Ferrite-cored High Frequency Current Transformer		Inductive	30
Transient Earth Voltage		Capacitive	5
Rogowski Coil		Inductive	1

Relative Sensitivity at 10 MHz of the 4 types of OLPD sensor

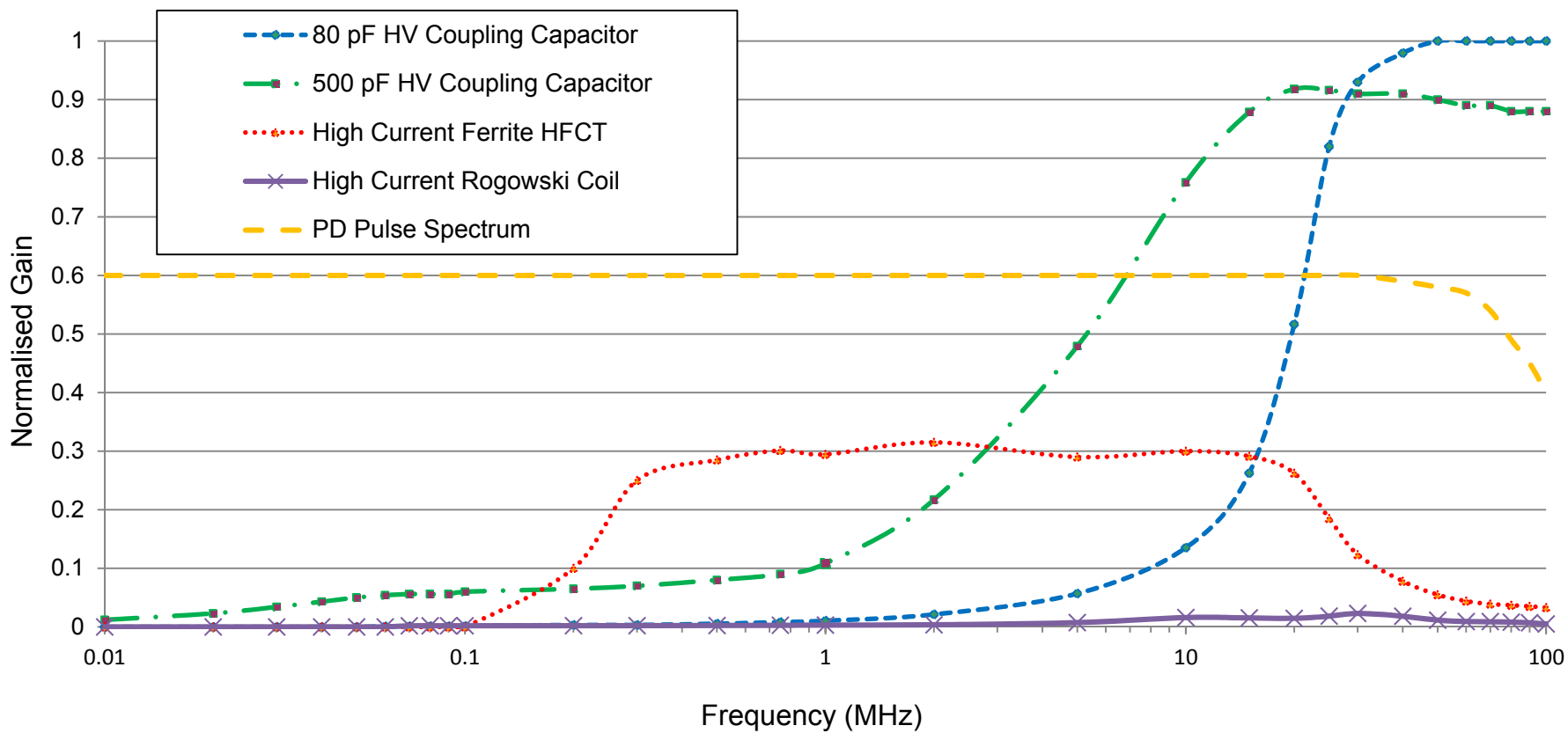

The choice of PD sensor depends on:

- The rating of the machine
- The size of the cable box
- Whether it is bus-fed (HVCC) or cable fed (HFCT)





High Voltage Capacitive Couplers (HVCCs)



**Permanent Rogowski
Coil (RC) Sensors**



**HFCT Installation in
an Ex/ATEX HV
motor terminal box**



**HFCT Installation (3) + 1x TEV
inside an HV switchgear box**

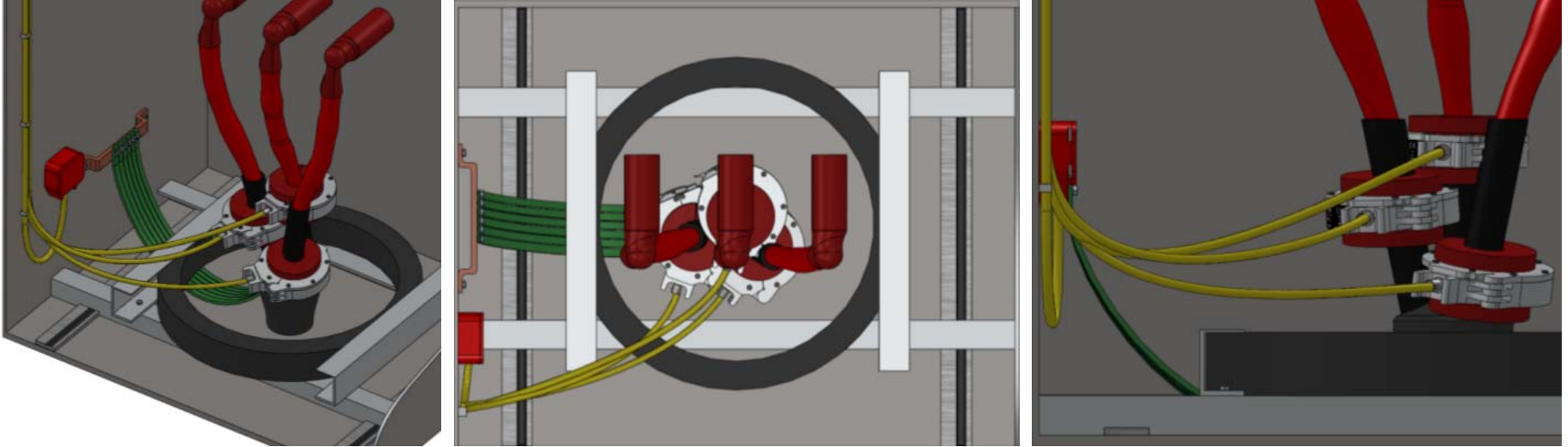

Safety Note: For this installation the HFCT sensors must be installed on the correct silicone collars for the diameter of the cable tail, within the 'extended earth zone' i.e. on the black, semi-conductive tubing with all clearances maintained.

Each rotating machine cable feeder termination has the following sensors installed:

- **1x TEV sensor** (to measure 'Local' PD in the switchgear/machine terminal box),
- **3x HFCT sensors** (one per phase) are used to measure PD in the HV cables **and** the remotely connected plant, whether this is a rotating HV machine or an HV transformer.







**OLPD Testing of 11 kV GT Generators
(Offshore Drilling Vessel, Angola)**



**OLPD Testing of 6.6 kV Gas Turbine
Generators (Cruise Ship, USA)**



**OLPD Testing of 10 kV Generators
(Oil Processing Facility, Algeria)**



**OLPD Testing of 11 kV Hydro Generators
(Power Generation Customer, Nepal)**



**Example of a 15kV HVCC Sensor Installation
(Oil Refinery, UK)**

PRESENTATION II

On-line and Off-line Partial Discharge Testing of Line-Fed HV Motors and Generators

A decorative graphic consisting of several overlapping, wavy, semi-transparent red lines that flow across the lower half of the slide.

Presented by:
Dr Lee Renforth,
Managing Director
HVPD Ltd

CONTENTS

- ***On-line*** (in-service) vs ***Off-line*** (out-of-service) PD testing
- Types of HV insulation defects in rotating HV machines
- PD pulse propagation analysis along HV feeder cables
- Phase Resolved Partial Discharge (PRPD) analysis

- **Case Study I** : On-line and Off-line PD testing and monitoring of 11kV generators on a drilling vessel.

- **Case Study II** : On-line and Off-line PD testing and monitoring of 6.6kV pump motors for a UK Power Generation client.

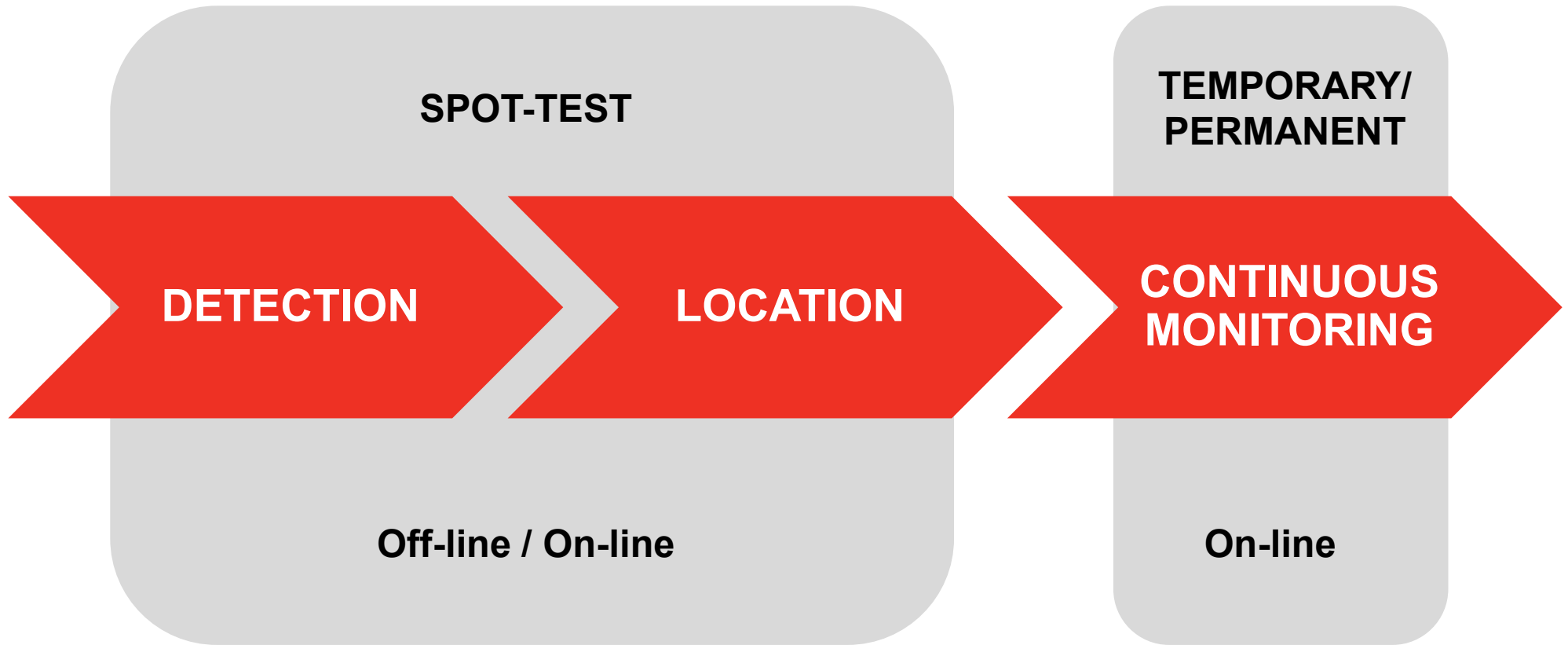



On-line

- In-service, under normal (and abnormal) working conditions
- Various sensor options are available

Off-line

- Energised with external HV power source
- Usually a High Voltage Coupling Capacitor (HVCC) sensor is used

ON-LINE	OFF-LINE
Advantages	Advantages
No need to isolate the circuit	Proven technology
Circuit loaded when tested	Better sensitivity
Economical & non-invasive	Drawbacks
Teed circuits can be tested	Circuit not loaded during testing
Drawbacks	Outage required
Data interpretation can be difficult	Expensive & time-consuming
Earthing pre-requisites	Teed circuits cannot be tested easily

The **phase-to-earth** PD propagation path is formed by the capacitances of the air-gap/discontinuity and the insulation, and the phase winding of occurrence.

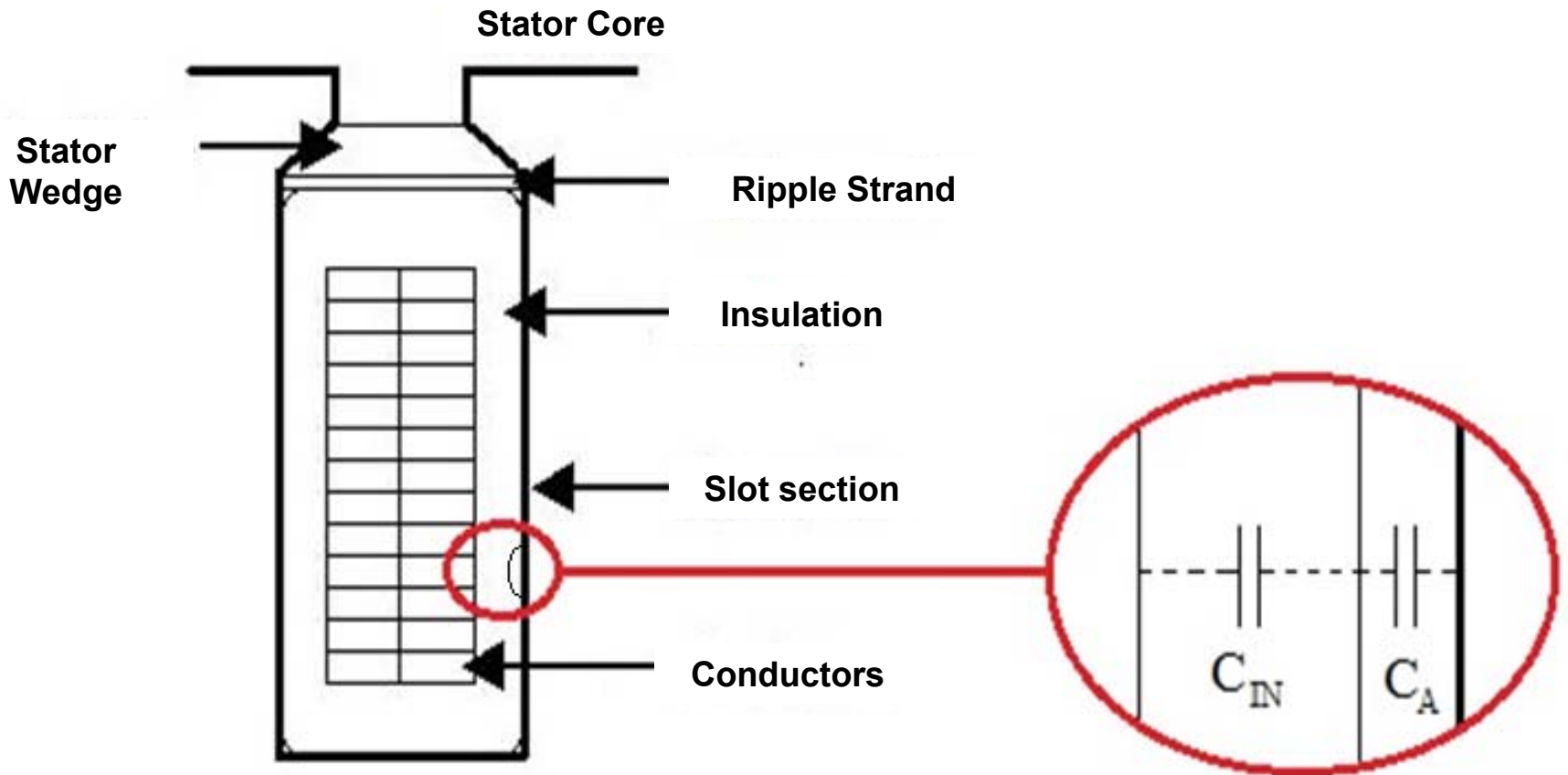

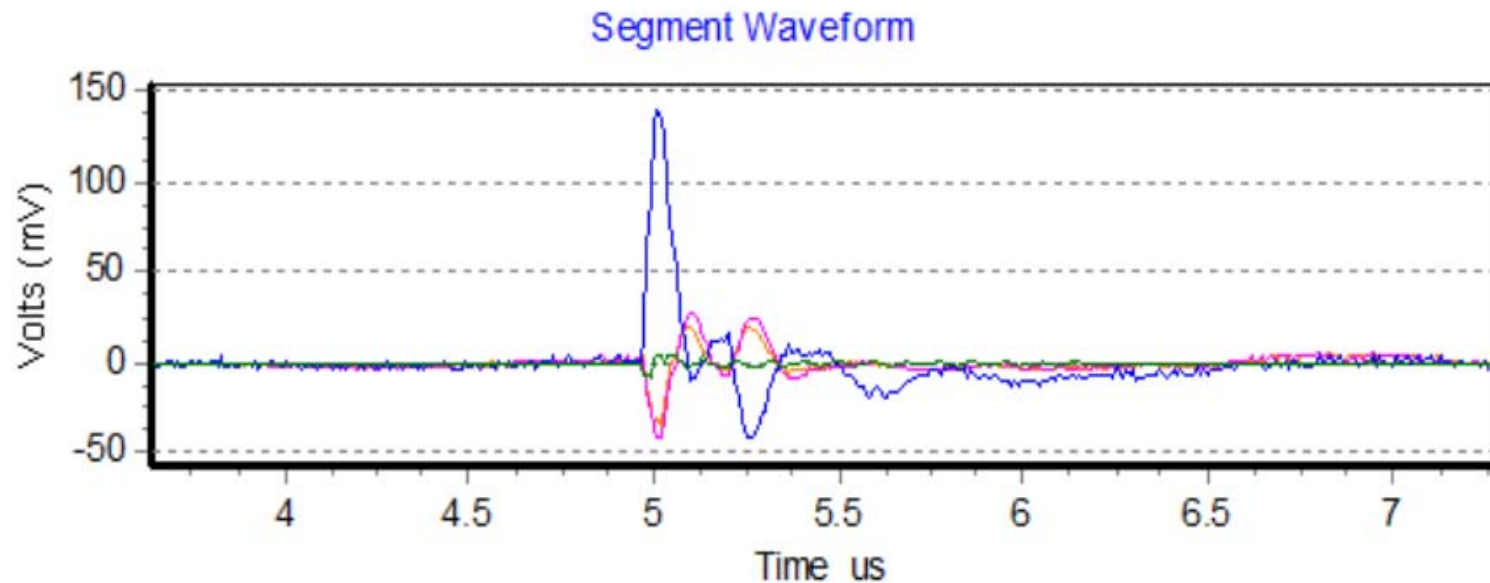

- These can be caused by surface discharges causing patches in the semi-conductive coating, delamination of the winding insulation and also vibration.
- The stator slot section PD produces a dominant pulse on one phase only (as shown above, in this case on the Blue Phase).
- Mutual coupling between phases often results in a very small, cross-coupled voltage pulse being seen on one or both of the other phases.

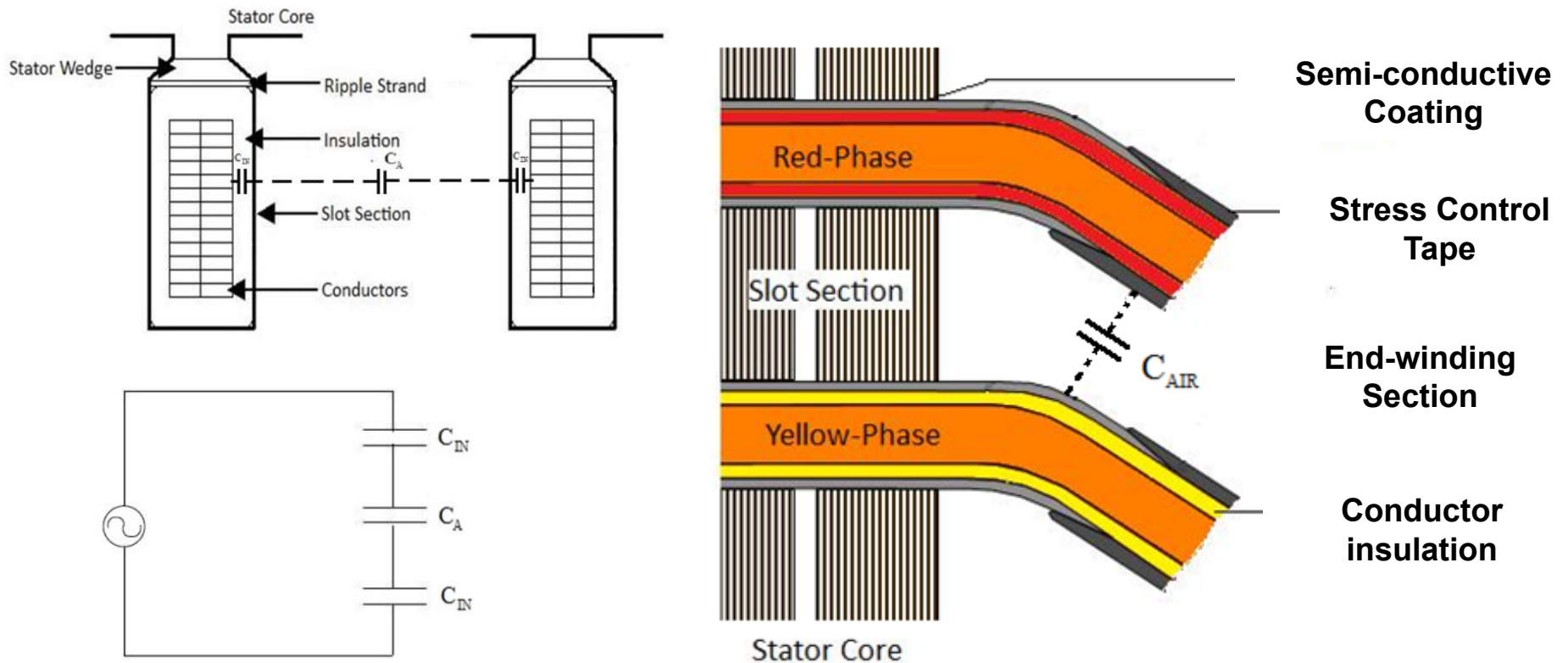

- Phase-to-phase PD mainly occurs at the end-winding region.
- These can be caused by inadequate stress-control, moisture ingress, contamination, in-sufficient clearances or excessive vibration.

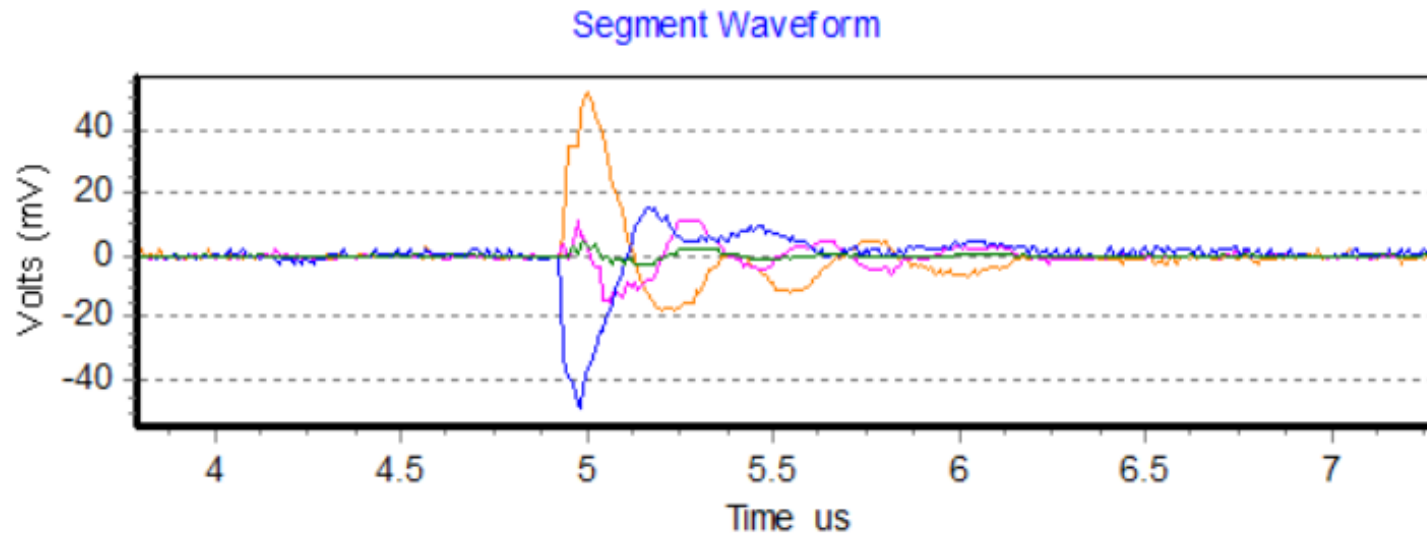

- This can be caused by end turn insulation breakdown which is typically initiated by contamination, moisture ingress, high humidity and insufficient bar clearances and stress-control plus vibration.
- The phase-to-phase PD propagation path is formed by the capacitances of the phase winding insulation and the air gap as well as the impedances of the phase windings the discharge occurs between.
- An end winding phase-to-phase PD produces equal and opposite pulses on two phases (as shown above, in this case the discharge is between the Orange and Blue Phases).

TYPES OF DEFECTS IN ROTATING HV MACHINES



- Loose stator bar, stator bar vibration
- Phase-to-earth discharges in the slot section
- Damaged HV conductors
- Surface degradation (e.g. at the end windings)
- Corona ring stress relief degradation
- Phase-to-phase discharges at the end windings
- Delamination of mica-based insulation
- Voids in resin/VPI insulation
- PD in the accessories (e.g. CT / VT / cable terminations)

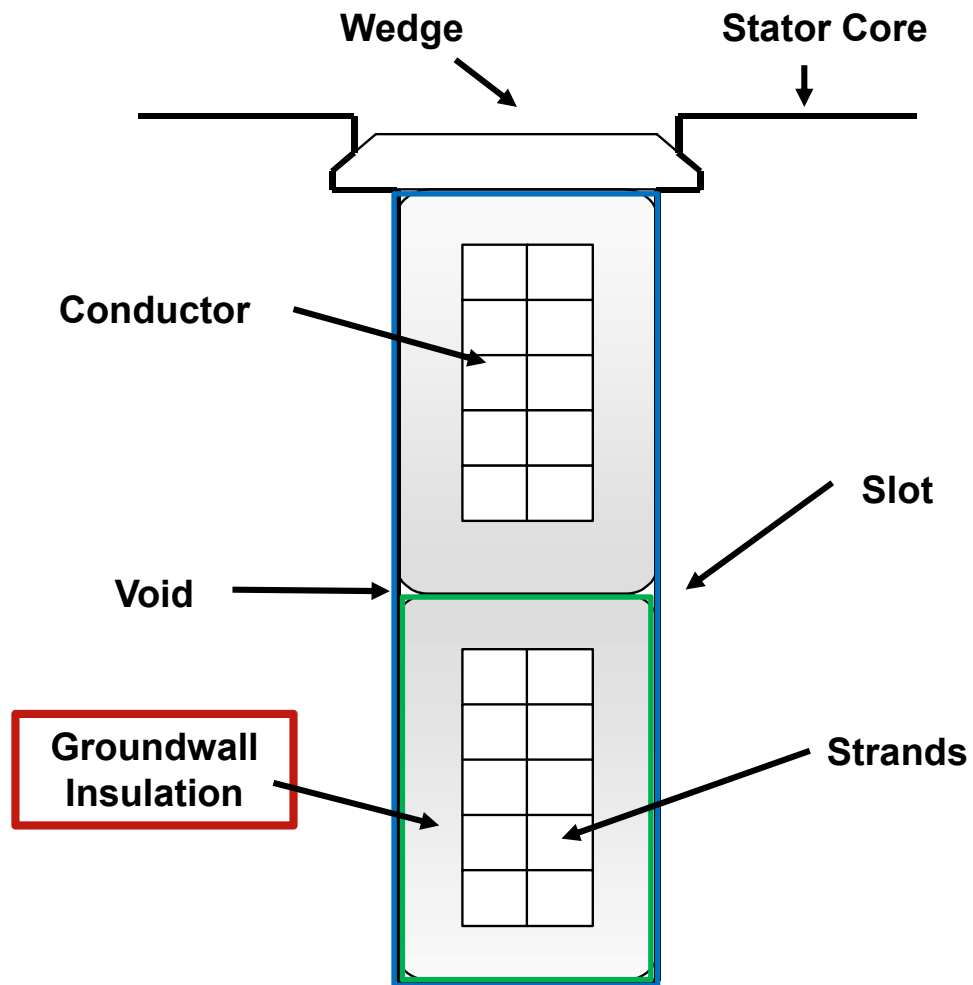

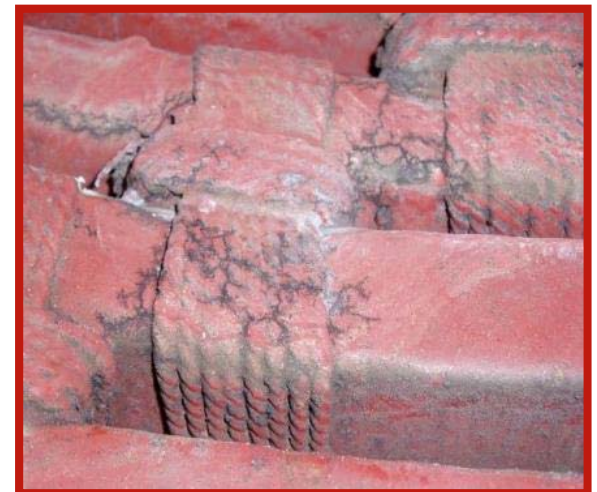
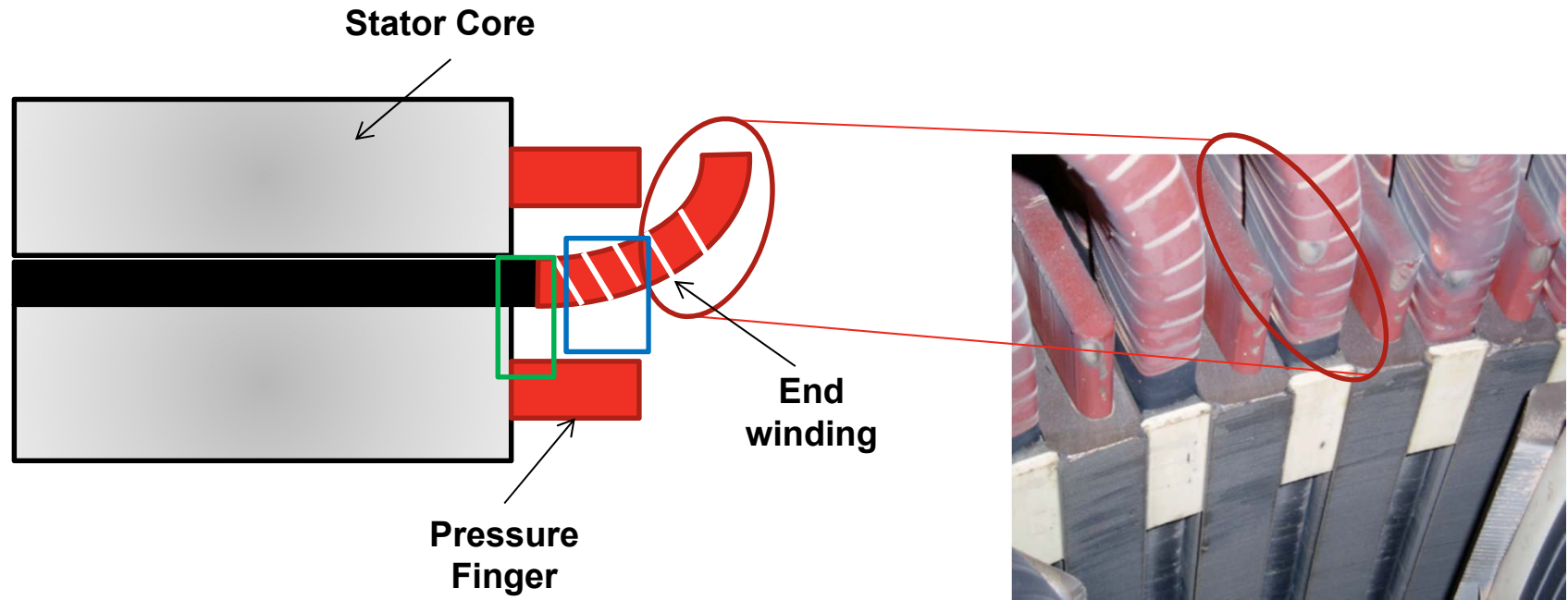



- This is very useful for identifying and confirming areas of surface degradation and tracking in the machine's **end windings** (by removal of the machine's end-caps).
- Requires de-energisation of the machine.
- It is **not** possible to view any degradation of the insulation in the **slot section** of the machine as this requires removal of the rotor (this is not a simple task and requires an extended outage).



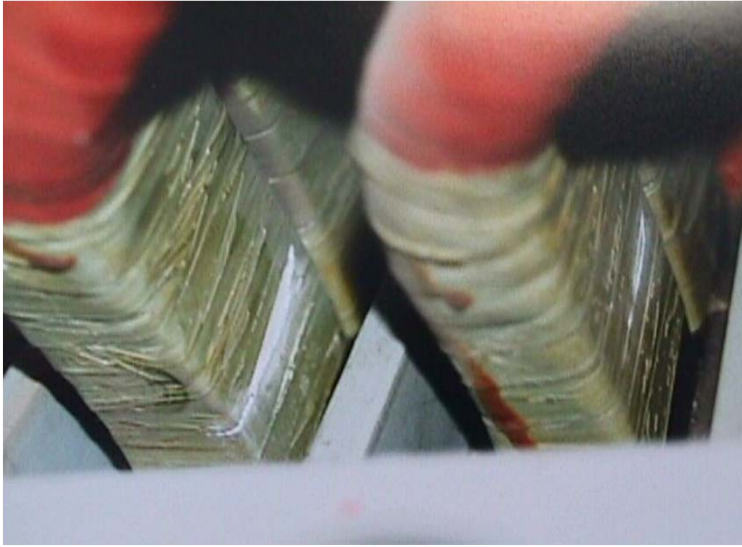

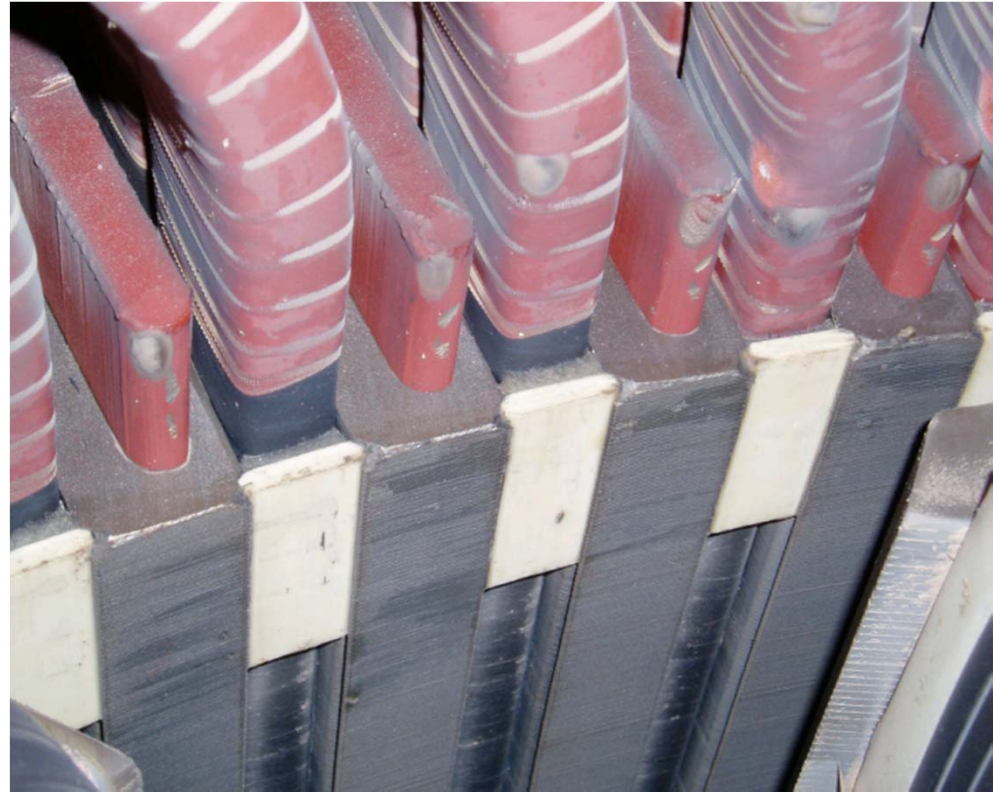



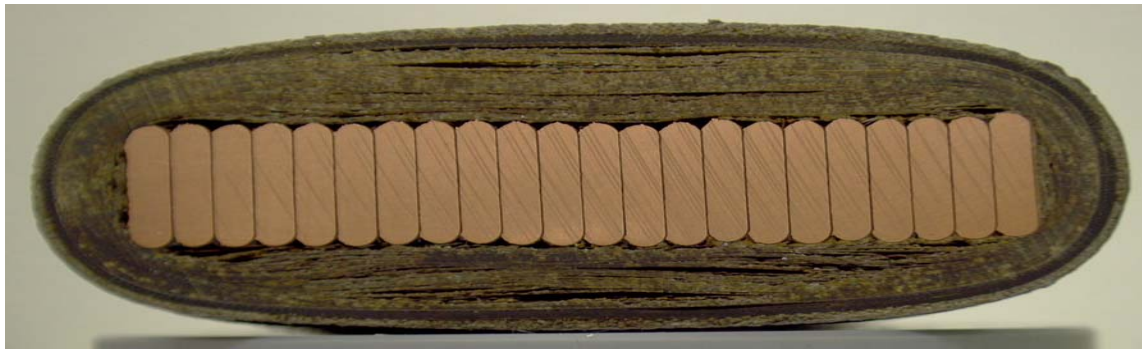
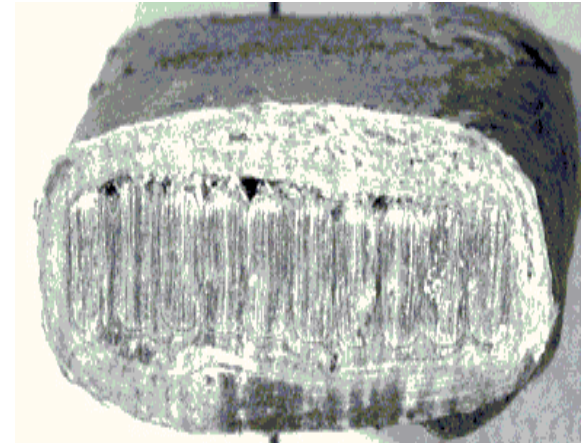
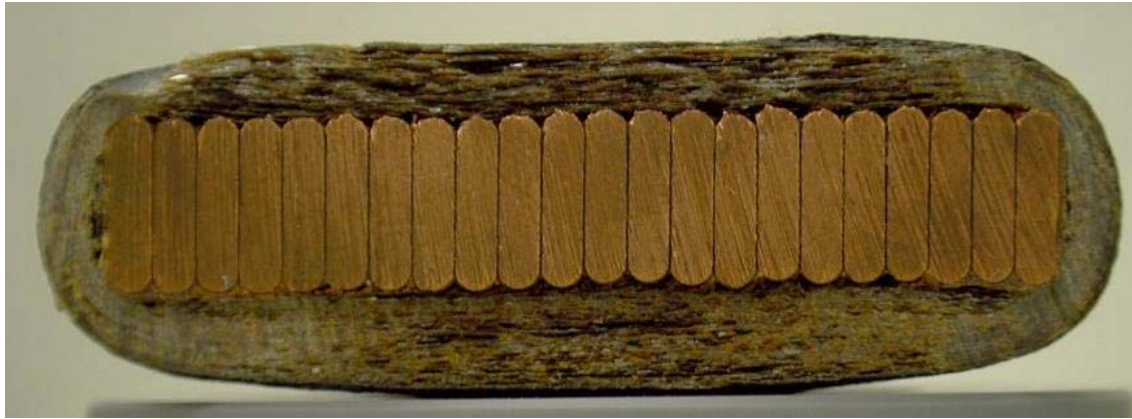

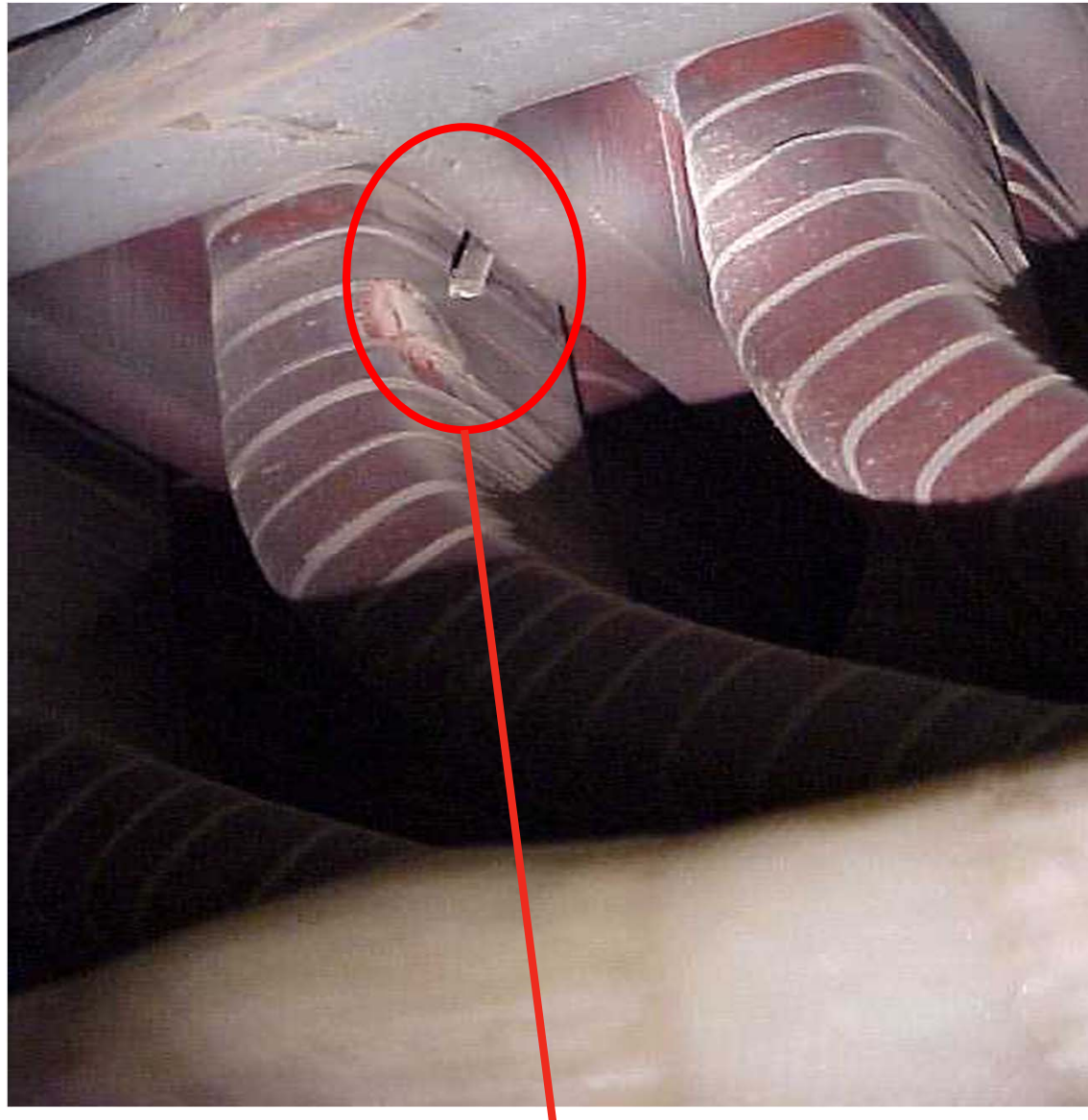

Localised surface discharge due to a foreign object lodged between iron and coil



PRESENTATION III

Remote OLPD monitoring of ***Ex/ATEX HV motors*** using wideband HFCT PD sensors at the central switchboards



Hazardous Gas Locations ‘Ex’/‘ATEX’ environment - IEC 60079-0 Definition:



“An area in which an explosive atmosphere is present, or may be expected to be present, in quantities such as to require special precautions for the construction, installation and use of electrical apparatus.”

- Common Types of Motor Protection: to “contain” an ignition (**Ex d – flameproof**), to exclude the gas (**Ex p – pressurised**), or does not present an ignition source (**Ex e or Ex n – increased safety or non-sparking**)
- Restrictions with plant design – e.g. for ventilation, either air circulating or heat-exchanger systems are used

Central HV Switchboard - an easier environment to monitor from

- No hazardous environment restrictions apply
- There is normally sufficient space and clearances within switchgear cubicles to install split-core, HFCT sensors
- Remote OLPD monitoring from the central switchboard is thus an attractive option when the motor to be monitored is in an Ex/ATEX hazardous gas zone

- Central monitoring of PD activity in **Ex/ATEX HV motor** stator windings using wideband HFCT sensors at the switchboard was reported by HVPD in an **IEEE-PCIC 2012** conference paper in September 2012.
- HVPD published a second paper at the **IEEE-PCIC 2013** conference in September 2013 with asset management condition guidelines for assessing the condition of large populations of aged (20+ years) Ex/ATEX HV motors based on an **'OLPD League Table'** database.
- Copies of these IEEE-PCIC papers, co-written with Chevron and TCO (Tengizchevroil), are available from HVPD on request.



The Monitor:
The HVPD Sync™ Monitor

OLPD Sensors:
1x TEV Sensor
& 3x HFCT Sensors
per motor feeder

MV Power Cables:
Measurement Range:
up to 1.0 km for PVC/PILC
up to 2.0 km for XLPE cables

4 MV 'Ex' Motors Monitored
(located in hazardous gas zones)

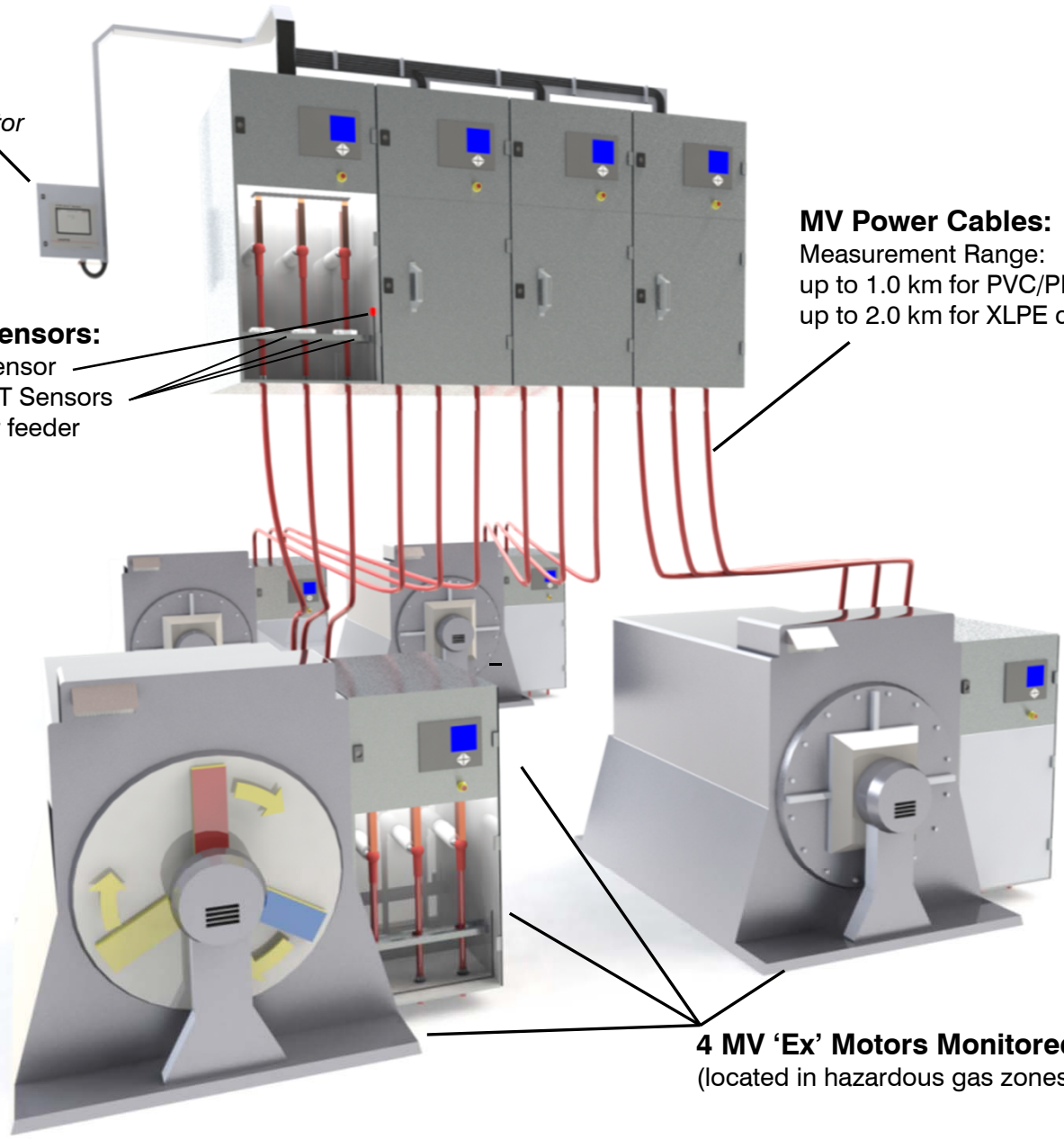



PD activity within the HV switchgear

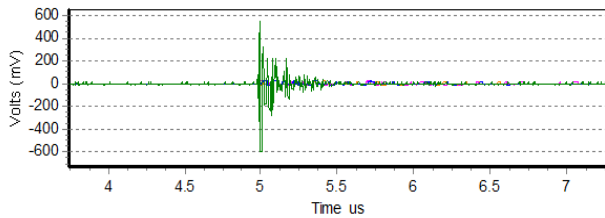

PD activity within the HV motor slot section

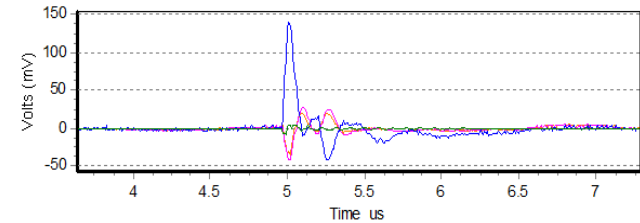

The Monitor:
The HVPD Sync™ Monitor

Safe Environment
(no restrictions apply)

MV Feeder Cables
Measurement Range:
Up to 1.0 km for PVC / PILC
Up to 2.0 km for XLPE cables

Ex/ATEX Environment
(restrictions apply)

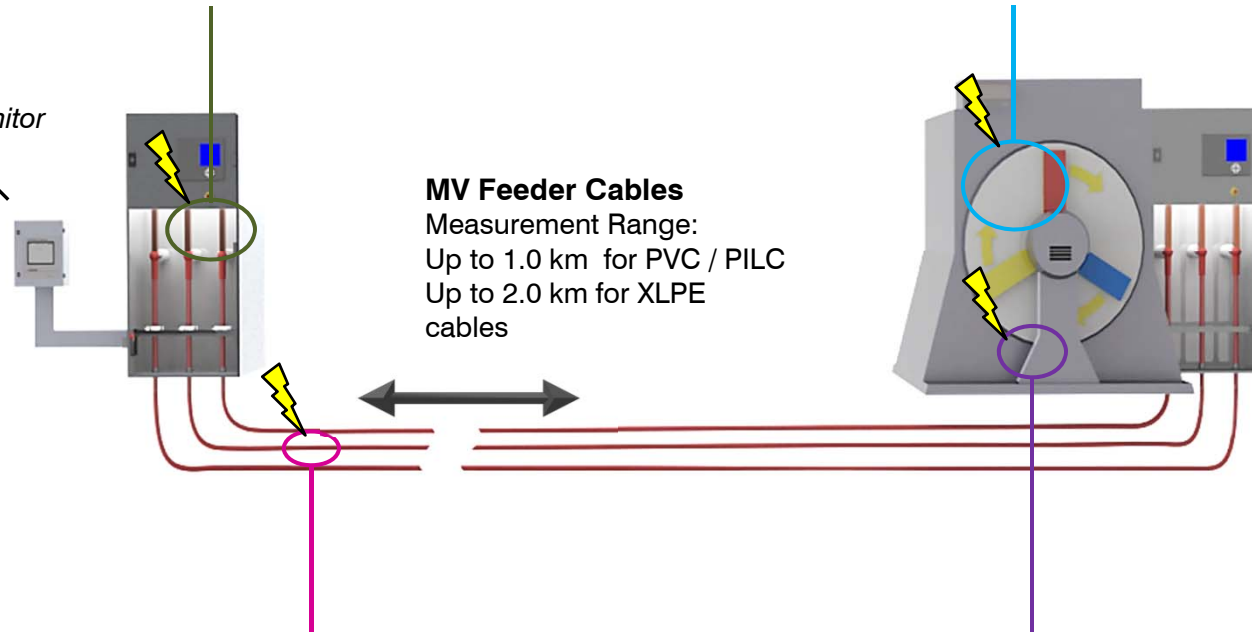

PD activity within the HV feeder cable

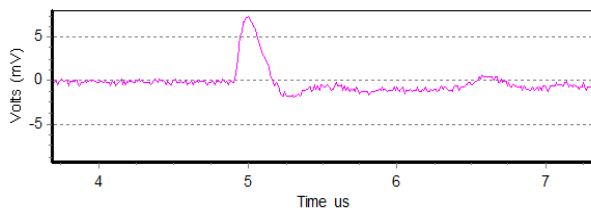

PD activity in the HV motor end windings

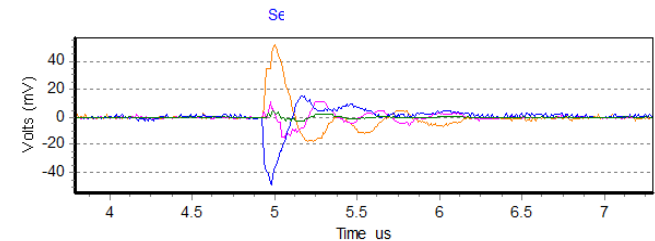

PARTIAL DISCHARGE PULSE PROPAGATION ALONG HV CABLE FEEDERS

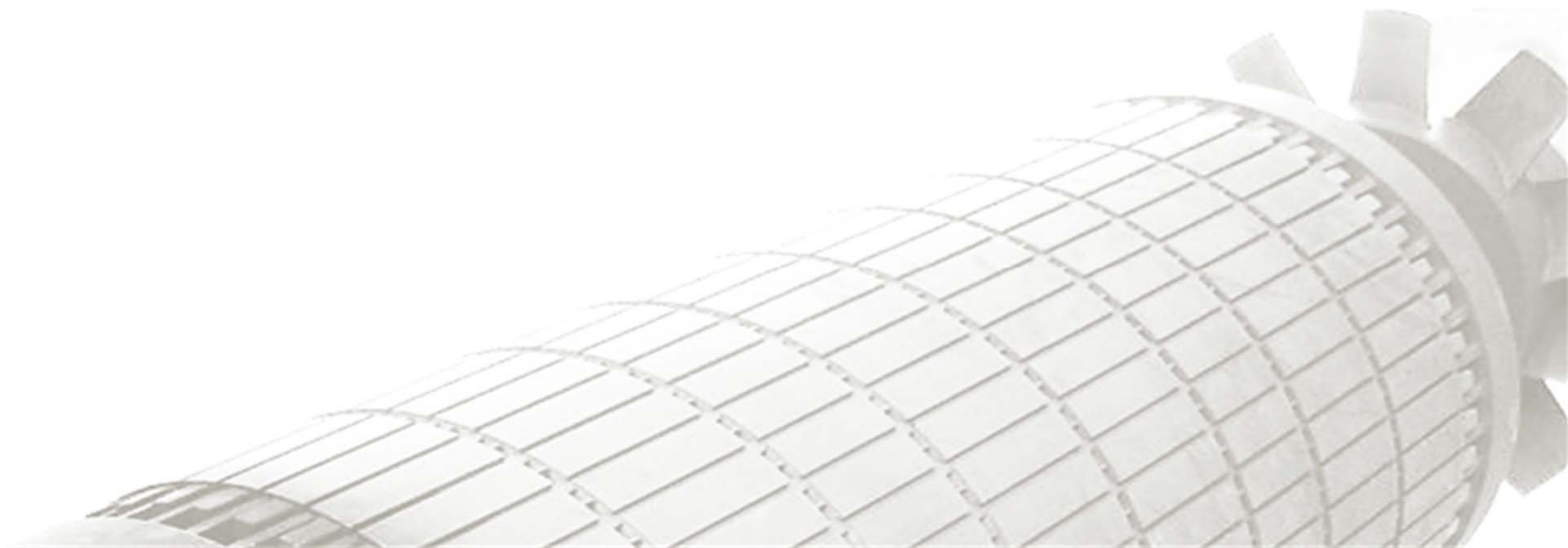

- At the discharge source the PD pulse can be modelled by a Dirac- δ function, with a broad frequency spectrum and a very fast (< 1 ns) rise time.

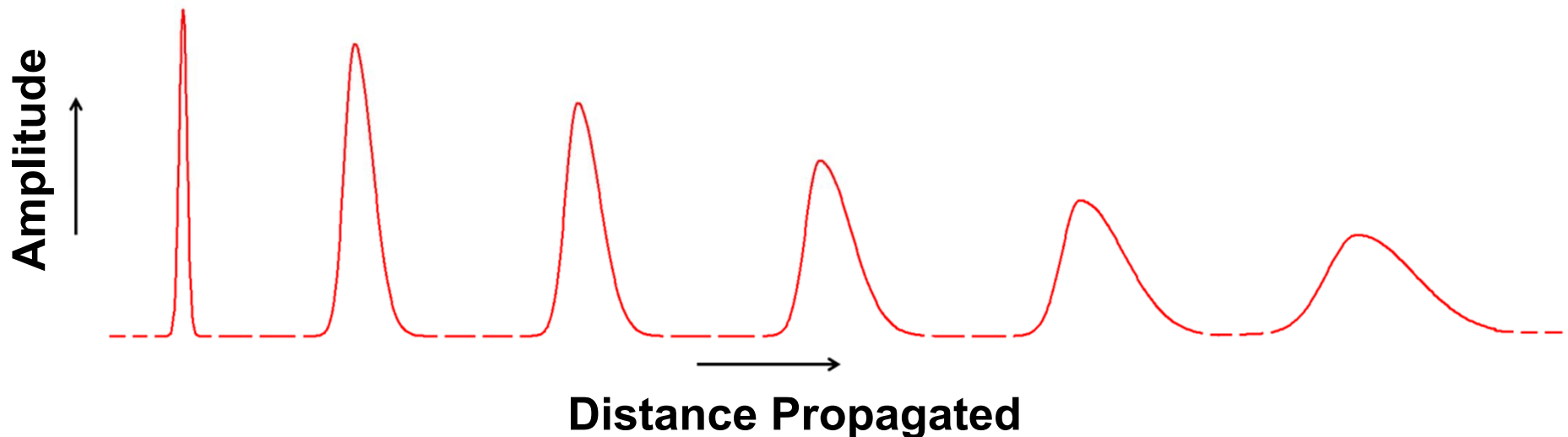

- As a PD pulse propagates from its source (within the machines' stator winding) to the machine terminals and then along the feeder cable from the machine back to switchgear, **it changes shape (as shown above)**.
- These changes occur due to the effects of attenuation and dispersion as the cable/stator winding acts as a low-pass filter, stripping out the high frequency content of the pulse and developing into a '**Shark-Fin**' shape.

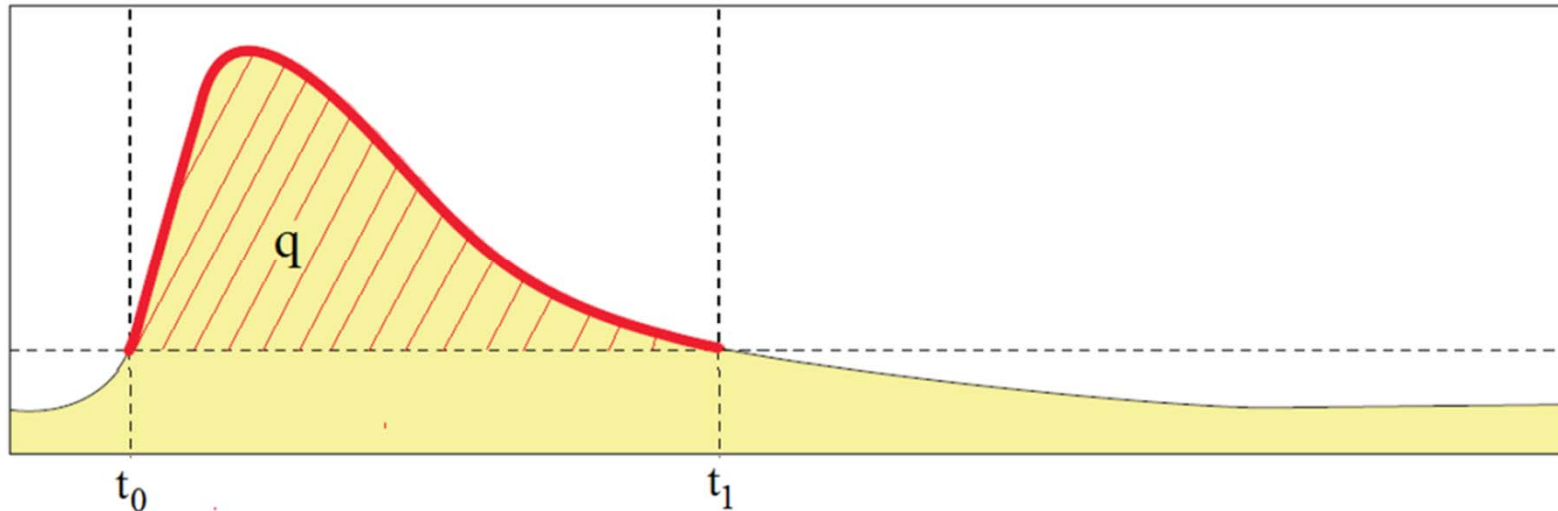

As the PD pulse travels down the HV feeder cable from its source in the rotating HV machine, it takes up a '**Shark-fin**' shape, as shown above.

By measuring the 3 main parameters of the pulse: risetime (t_r); pulse width (PW); and falltime (t_f), it is possible to identify and discriminate the PD pulse from electromagnetic (E/M) 'noise'.

The Charge Content (q) of the pulse (in Coulombs) is calculated using the Transfer Impedance (Z_{Tr}) of the HFCT sensor using the following equation:

$$q = \frac{1}{Z_{Tr}} \int_{t_0}^{t_1} V dt$$



PD Pulse Propagation Analysis

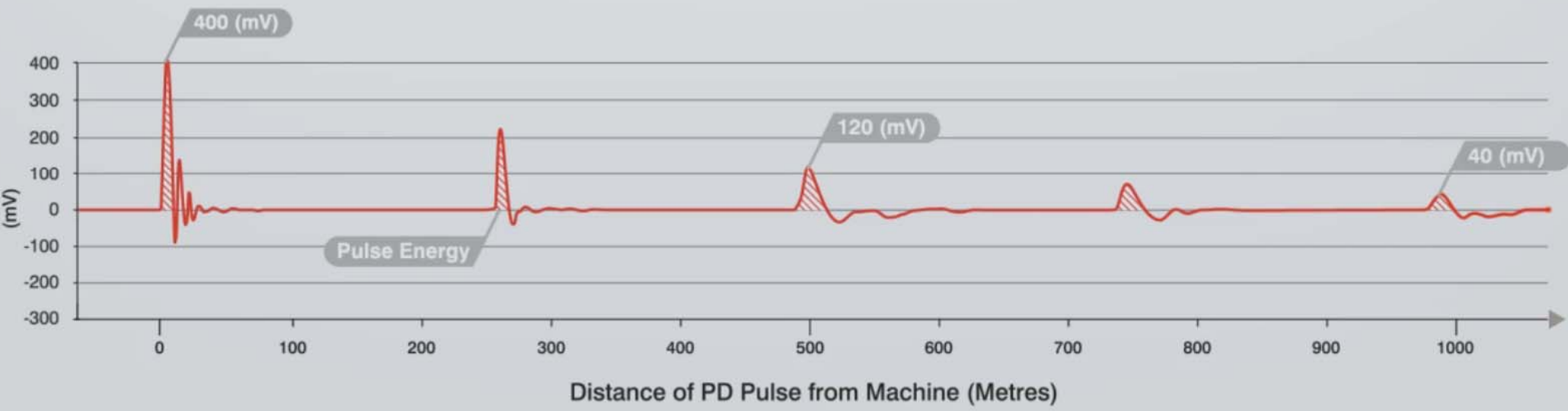

‘Clustering’ analysis of PD pulse widths shows how frequency dependent dispersion and attenuation increases the width of the PD pulses as they propagate along the cable from their source within the HV motors’ stator winding.

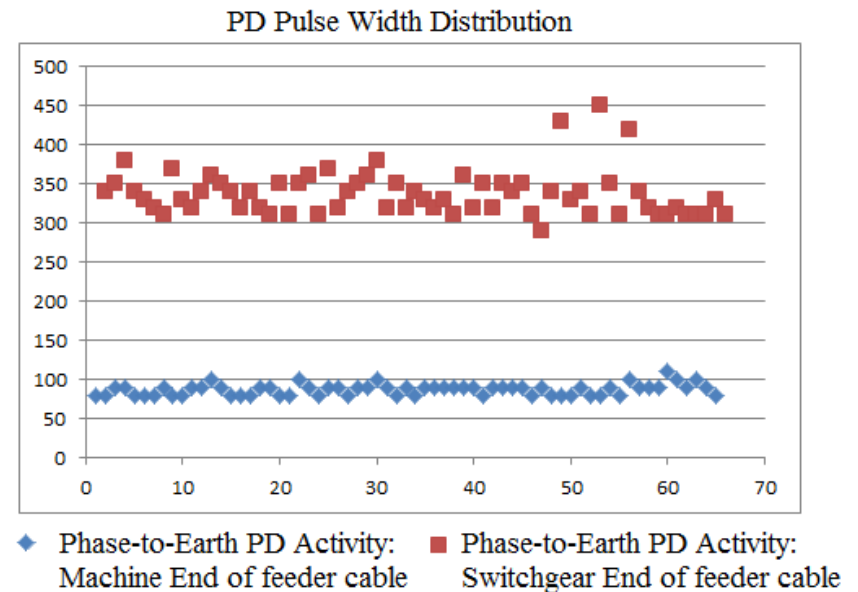
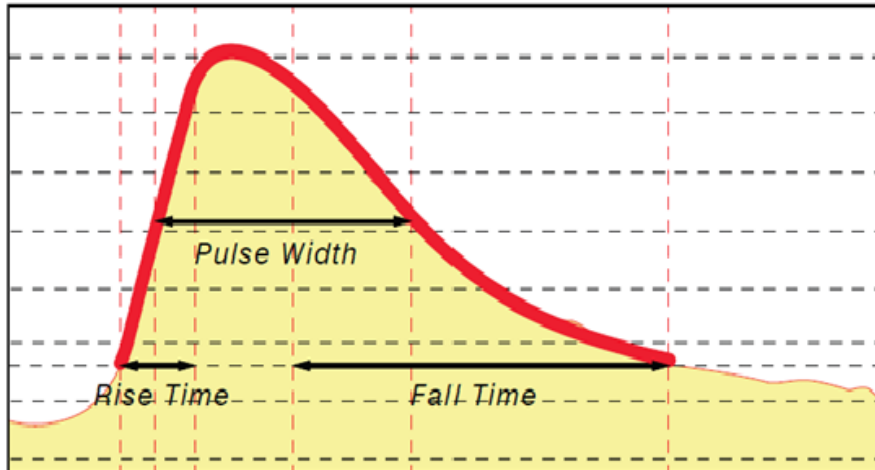

- The pulse widths for the ‘at HV motor’ measurements are in **blue (~90 ns)**, and,
- The pulse widths for the same pulses detected at the switchgear cable end of the circuit (350 m away from the rotor) are in red (**~340 ns**)

One 50 Hz power cycle of raw data from an HFCT sensor with an A to D Digitisation at 100 MS/s

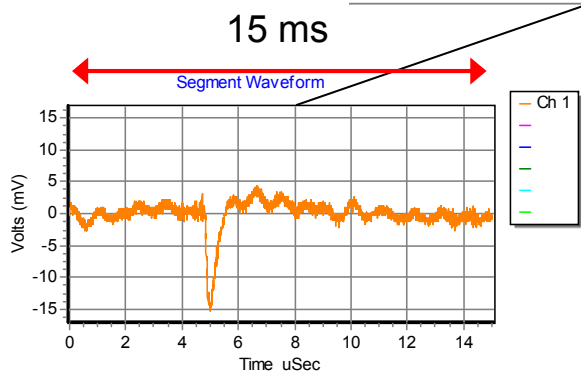
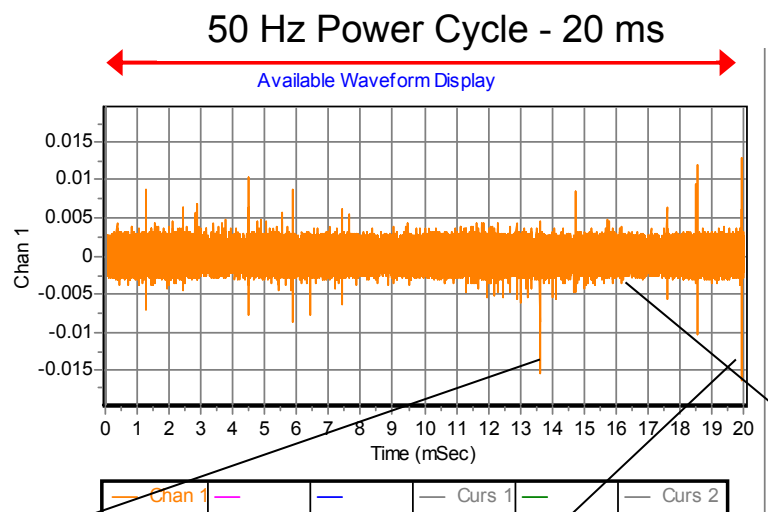

Machine PD Pulse: 16 mV, 1160 pC

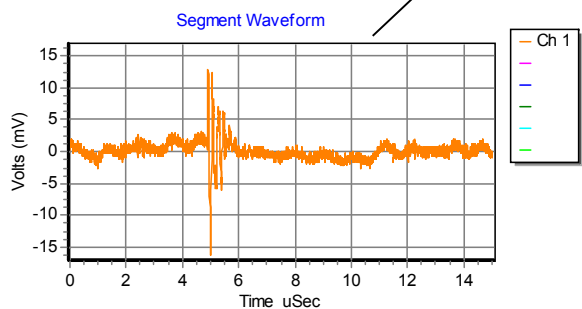

Switchgear PD Pulse: 15 mV, 24 dB

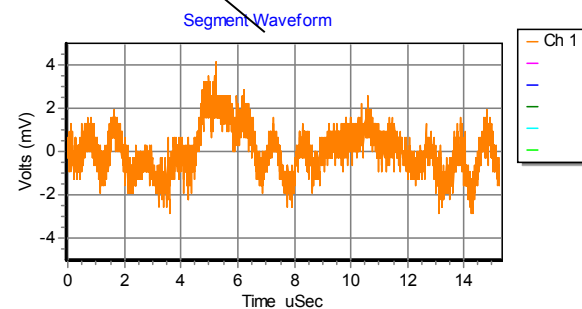

E/M Noise Pulse: 6 mV

ROTATING HIGH VOLTAGE (HV) MACHINES (3.3–15 kV)				
INSULATION CONDITION ASSESSMENT	PD Peak Level		PD Activity	
	High Frequency Current Transformer (HFCT) (nC)	High Voltage Coupling Capacitor (HVCC) (mV)	High Frequency Current Transformer (HFCT) (nC/Cycle)	High Voltage Coupling Capacitor (HVCC) (mV/Cycle)
Excellent	<2	< 20	<50	<500
Good	2–4	20–40	50–100	500–1000
Average	4–10	40–100	100–250	1000–2500
Still acceptable	10–15	100–250	250–500	2500–5000
Inspection recommended	15–25	250–600	500–1000	5000–10000
Unreliable	>25	>600	>1000	>10000

The analysis of OLPD test results is based on:

- PD level trends – e.g. the PD activity doubling in 12 months is a sign of severe insulation deterioration.
- Phase Resolved PD (PRPD) patterns – different defects have different phase patterns across the 50/60 Hz power cycle.
- PD pulse ‘*waveshape*’ this can identify both phase-to-phase and phase-to-earth PDs and different PD sites within the machine’s stator winding.

Jan 2009	June 2009	Jan 2010
8 nC	10 nC	17 nC

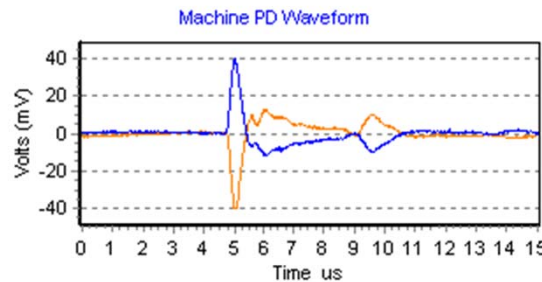
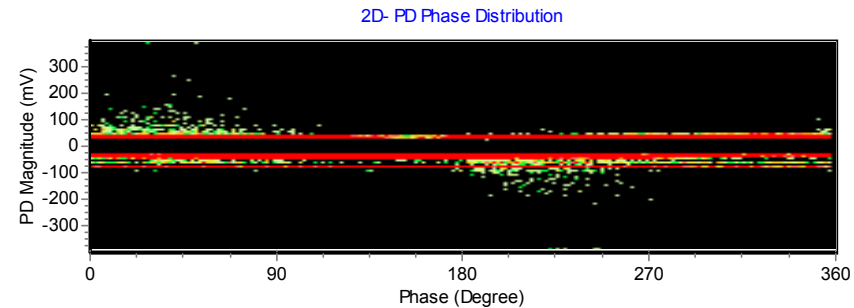

Phase-to-Phase PD

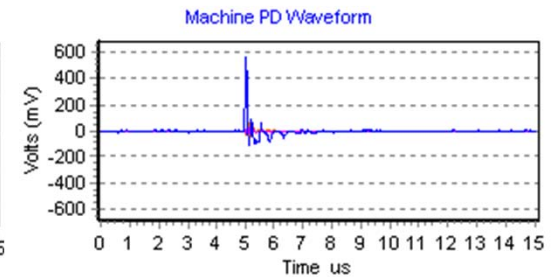

Phase-to-Earth PD



OLPD Sensors at the Switchgear Panel to Monitor the Complete HV Circuit

- HVPD recommend the use of a **combination of three (3) OLPD sensors**, installed at the central switchboards, as follows:
- **High Frequency Current Transformer (HFCT)** sensors (one per phase) are used with to detect PD in the HV cables and the remotely connected plant (transformer or rotating machine)
- **Transient Earth Voltage (TEV)** and **Airborne Acoustic (AA)** sensors are located inside the HV switchgear panels to monitor the sectionalised areas shown opposite.
- All co-axial signal cables are safely routed through to the LV section of the switchgear and then out of the switchboards to the HVPD-Sync monitor unit located in the substation.

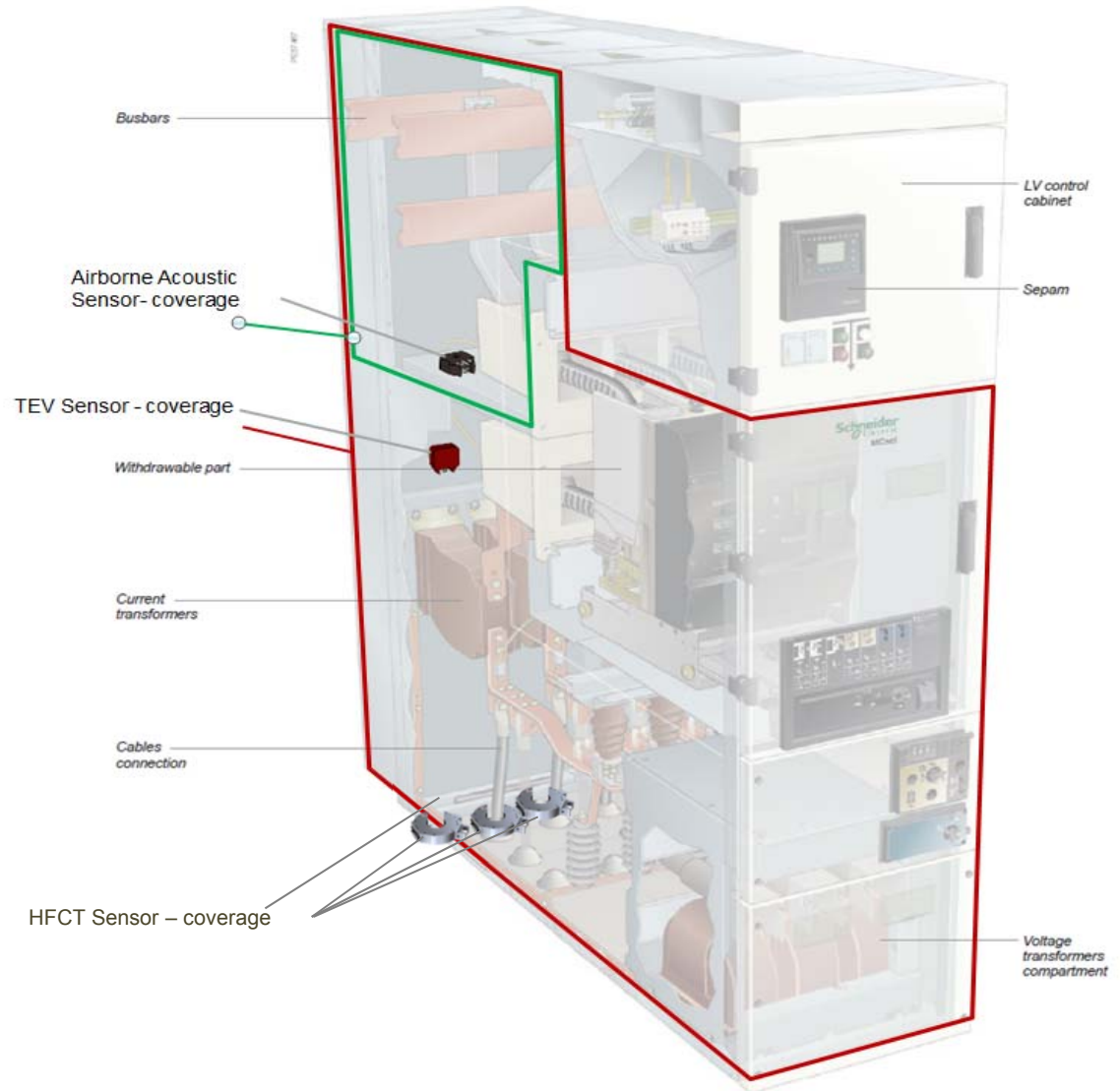

11kV AIS Switchgear
 11kV XLPE Cable
 11kV 'Ex' Motors
 (in hazardous gas zones)

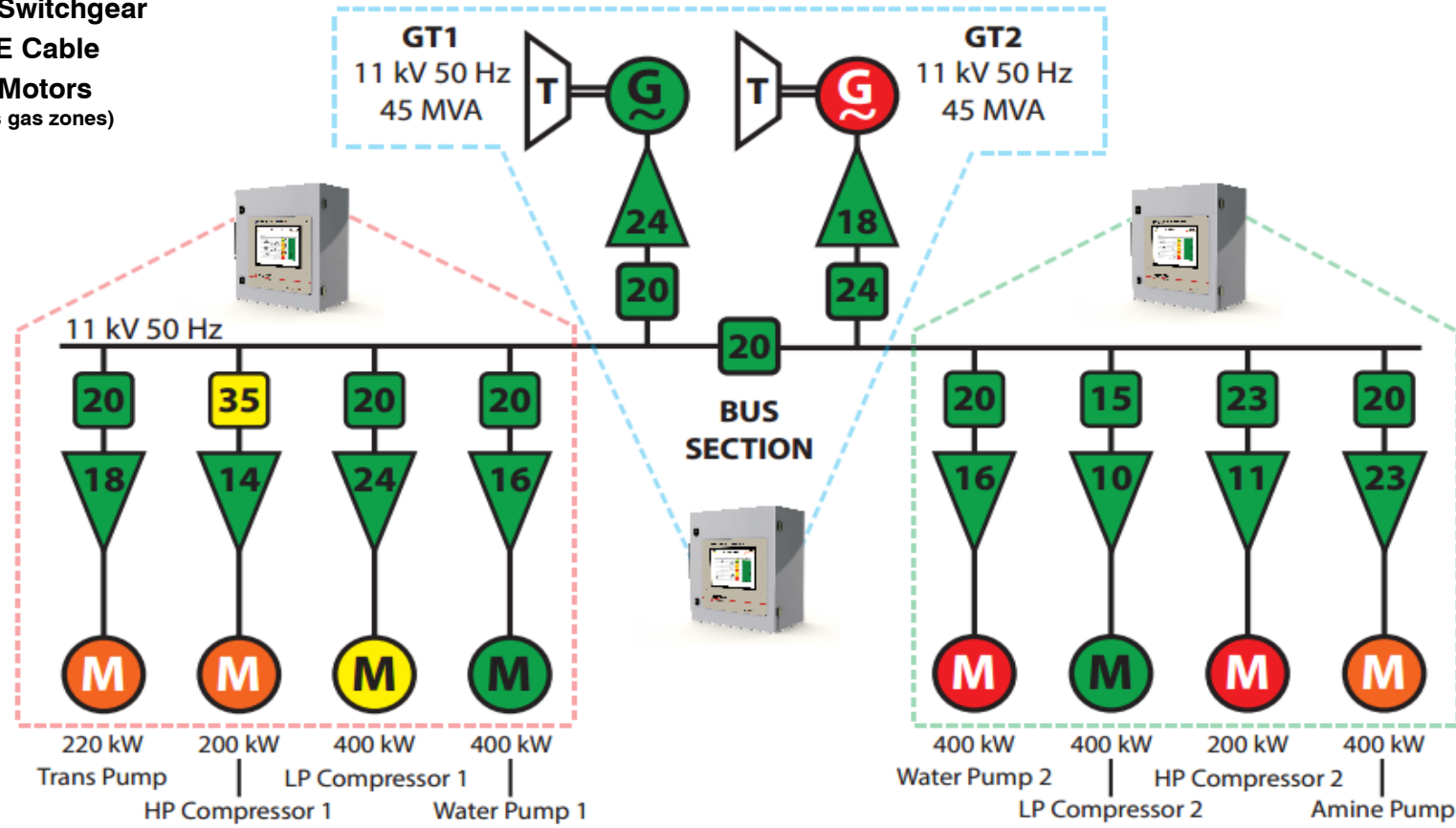

KEY: ▾

Monitoring Period: 12/09/13 08:24 - 13/09/13 08:24
 Last 24hrs Last Week Last Month

- = Cable Feeder (Cable Criticality)
- = Generator (Machine Criticality)
- = Turbine
- = Panel (Local Criticality)
- = Motor (Machine Criticality)

Reference	Comments	PD Monitor Trend	Condition
GT2	Slot/End-Winding PD Local Switchgear PD	Increasing PD	Unreliable
WATER INJECTION PUMP 2	End-Winding PD	Increasing PD	Unreliable
HP COMPRESSOR 2	End-Winding PD Local Switchgear PD	Increasing PD	Unreliable
AMINE PUMP	Slot Section PD	Increasing PD	Probable Inspection
HP COMPRESSOR 1	Slot/End-Winding PD	Increasing PD	Probable Inspection
TRANSFER PUMP	Slot/End-Winding PD	Stable PD	Probable Inspection
LP COMPRESSOR 1	Slot Section PD	Stable PD	Acceptable
GT1	Slot/End-Winding PD	Increasing PD	Good
WATER INJECTION PUMP 1	Slot/End-Winding PD	Stable PD	Excellent
LP COMPRESSOR 2	Slot/End-Winding PD	Stable PD	Excellent



COMPLETE HIGH VOLTAGE (HV) NETWORK OLPD MONITORING



- Comprehensive OLPD monitoring coverage of entire HV networks, including **generators/motors, switchgear, cable and transformers**.
- Real-time pooling of insulation Condition Monitoring (CM) data from multiple sensors / monitoring units across the network.
- Networking of this data is made to the remote **Decision Support Centre (DSC)** at HVPD for logging, comparison and trending.
- The condition of individual plant items is displayed on a user interface that contains the network's **single line diagram** with superimposed colour-coded plant condition indicators.
- The CM data allows the network operator to identify any plant with a significant risk of insulation failure and **schedule preventative maintenance interventions** to avoid outages.



- The HVPD-Multi™ Monitor does not provide automated alarms but provide ‘*flags*’ for further engineer investigation
- These ‘Flags’ can signal an increase in either PD level or PD activity but can also be caused as a result of network switching
- Each ‘Flag’ is investigated by HVPD engineers before a diagnostic decision is made regarding preventative maintenance interventions.



**Increase within
acceptable limits**

**Some
Concern –
Monitor
Closely**

**Major
Concern -
Intervention**

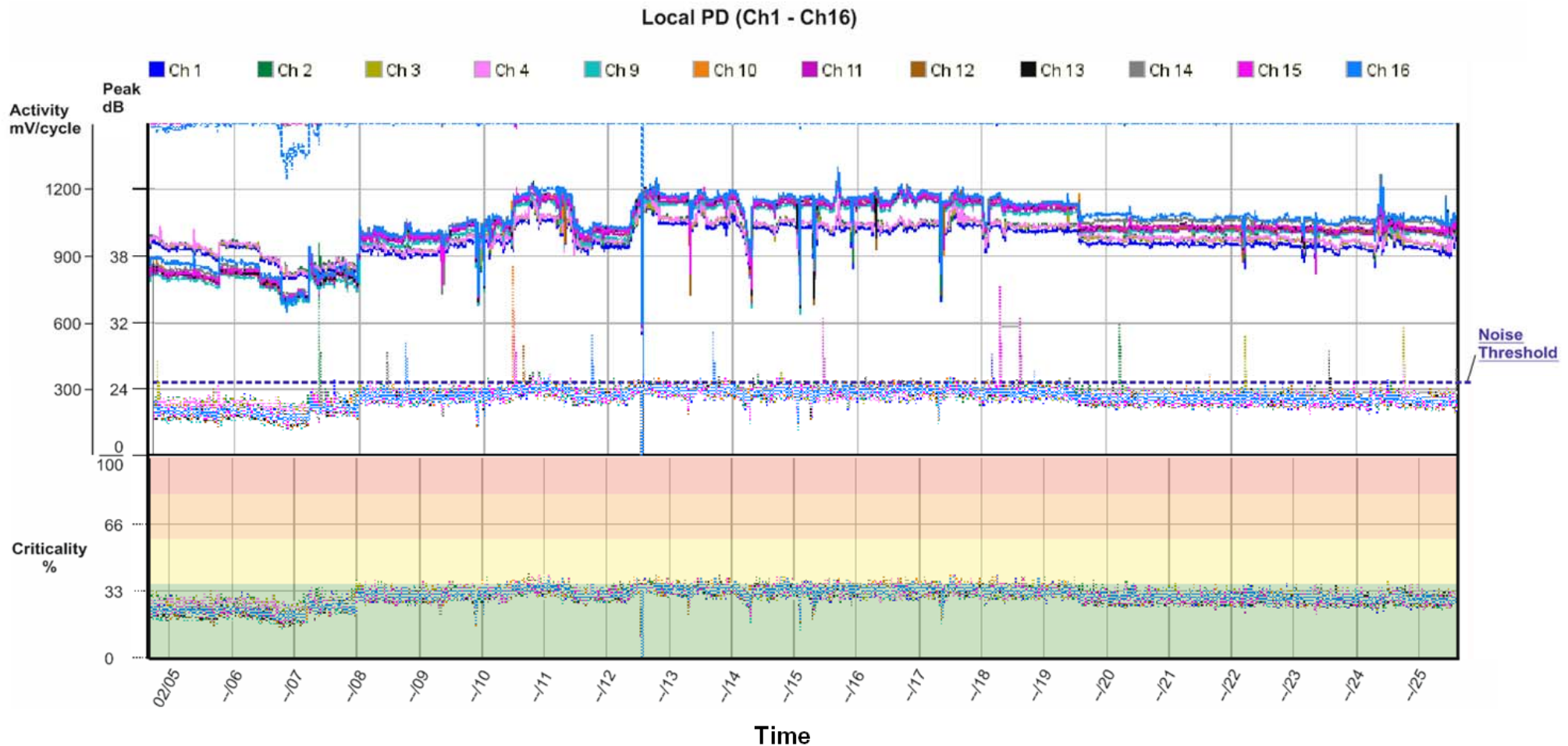

- The intermittent noise spikes (top) were removed to give % criticality values.
- After removal of the noise spikes by the software the PD levels for this HV motor showed low levels of PD with OLPD criticality levels of 22–36%.

INSTALLATION



DAY 1

DATA ANALYSIS

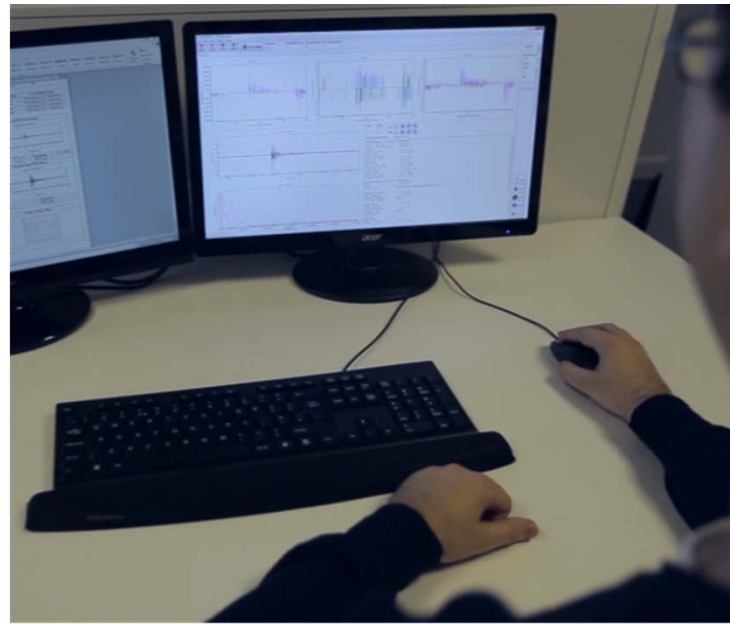

DAILY DATA ANALYSIS

ADJUSTMENT



DAY 30

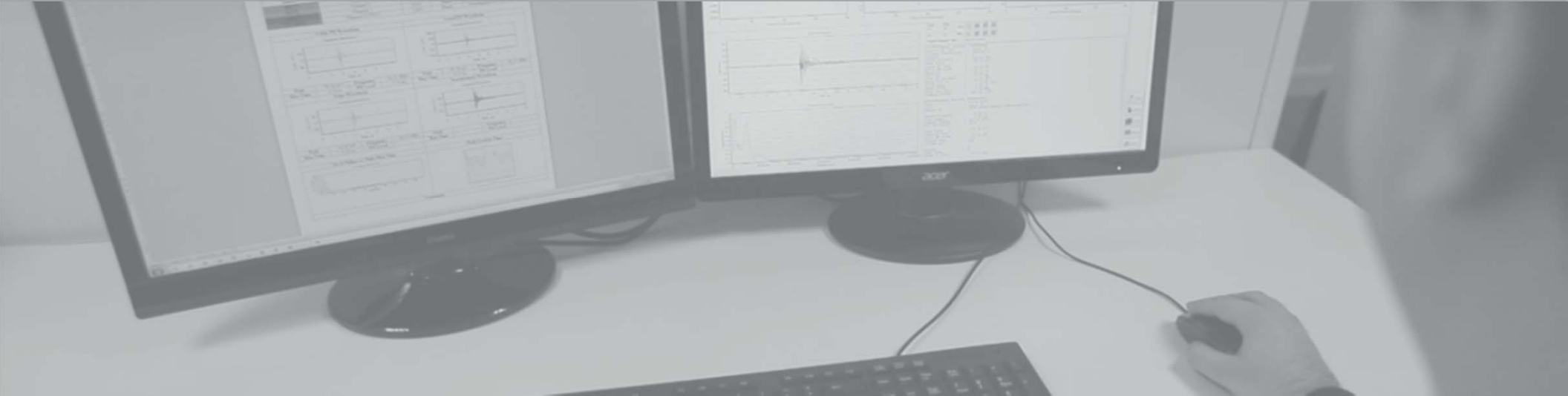

- The data is analysed on a daily basis with the previous 24 hours of data compared against the present 24 hours of date
- At the end of the training period, the background noise level thresholds and software filter settings are adjusted
- This approach helps to avoid ‘false alarms’ being accidentally triggered by noise spikes and HV network switching



EXAMPLE OF HV NETWORK OLPD MONITORING SYSTEM USER INTERFACE FOR A CLIENT'S LARGE OIL REFINERY HV NETWORK SINGLE-LINE DIAGRAM (SLD)



HVPD TCO Monitoring Database

Analysis / Reports Substations / Network Selection

Local Area Network Criticality League Table

Networks	Criticality (0-100)	
	Cable	Local
Grid Connection 400 kV	0	0
Offshore 132 kV Export	0	0
Trans Network 110 kV	47	26
Industrial Network 110 kV	0	0

Condition/Action Guideline	Criticality (0-100)
High PD / Diagnostic	76-100
Moderate to High PD / Investigate	51-75
Moderate PD / Monitor	26-50
Plant OK / No Action	0-25

Key

- Cable / Machine PD Activity
- Local PD Activity

Monitoring Period

- Last Hour
- Last 24 Hours
- Last Week
- Last Month

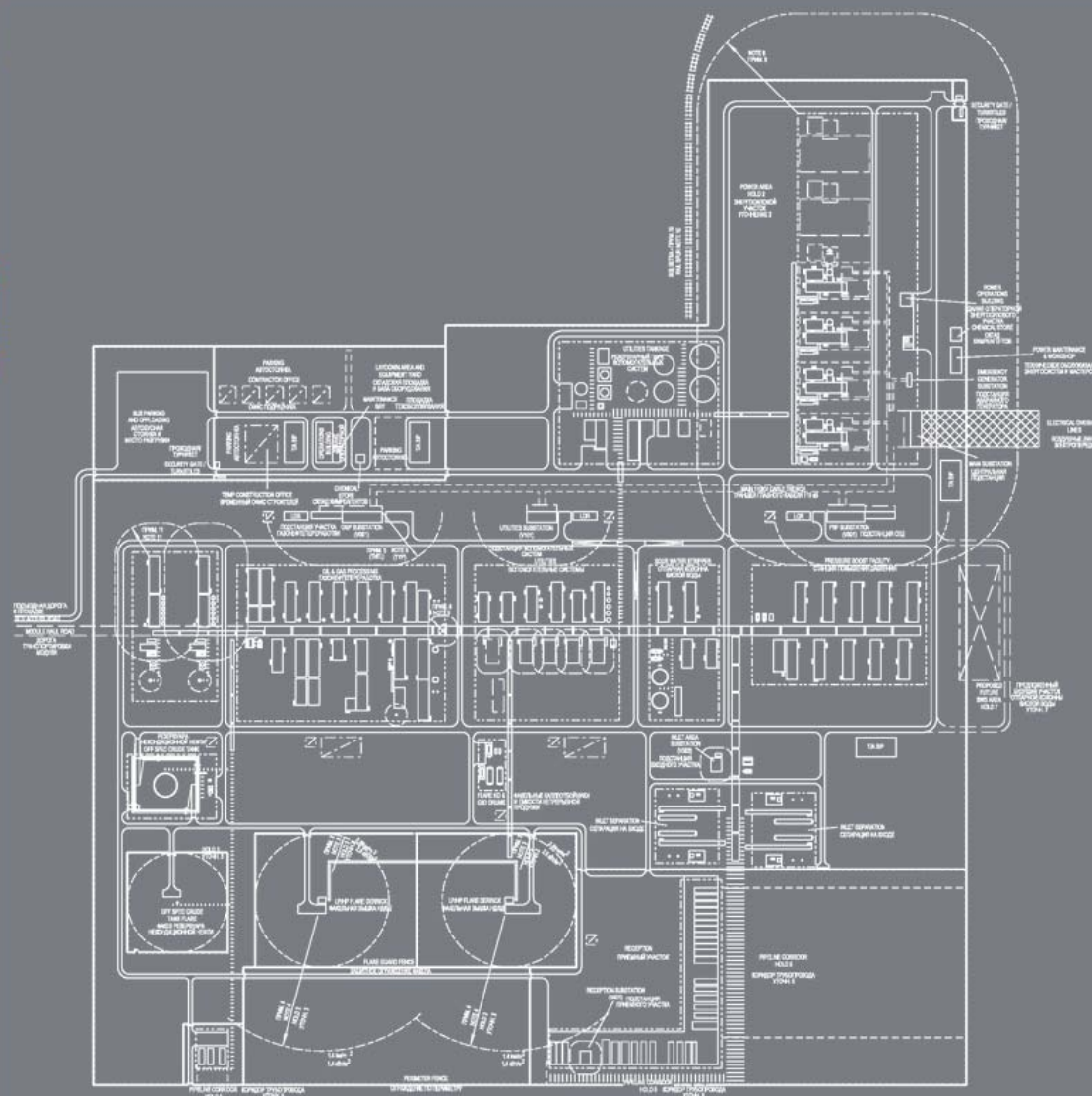

Network Options

View Level

- GEO : TCO Overview
- SLD : TCO Overview
- Substation : select
- Location : select

Networks

- Grid Connection 400 kV
- Offshore 132 kV Export
- Trans. Network 110 kV
- Industrial Network 110 kV

Sensor Configuration

Monitor Configuration

PD Measurements

HVPD TCO Monitoring Database

Analysis / Reports Substations / Network Selection

Local Area Network Criticality League Table

Substations	Criticality (0-100)	
	Cable	Local
3GP MAIN	0	0
43-SU-3302	0	0
47-SU-3301	0	0
47-SU-3311	0	0
CDS	0	0
CORE	47	25
NPS-480	0	0
RP 1.1	0	0
RP 2.1	0	0
SGP	0	0
TGTS1	0	0
TGTS3	0	0
TGTS4	47	26
TRAIN5	0	0

Condition/Action Guideline	Criticality (0-100)
High PD / Diagnostic	76-100
Moderate to High PD / Investigate	51-75
Moderate PD / Monitor	26-50
Plant OK / No Action	0-25

Key
● Cable / Machine PD Activity
■ Local PD Activity

Monitoring Period
 Last Hour Last 24 Hours
 Last Week Last Month

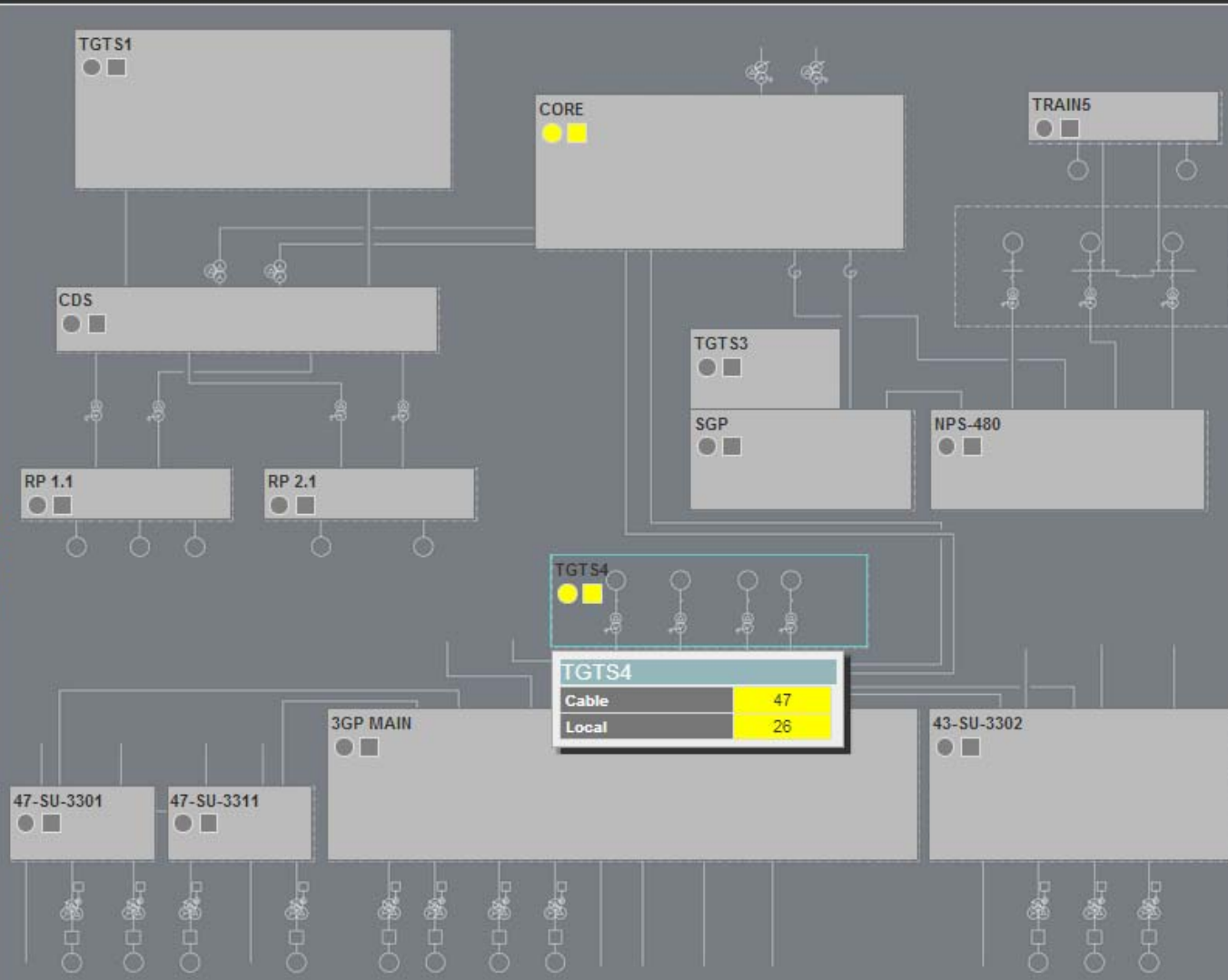

Network Options

View Level

- GEO : TCO Overview
- SLD : TCO Overview**
- Substation : select
- Location : select

Networks

- Grid Connection 400 kV
- Offshore 132 kV Export
- Trans. Network 110 kV**
- Industrial Network 110 kV

Sensor Configuration

Monitor Configuration

PD Measurements

Analysis / Reports Location : Gen 52-GP-9401.1

Local Area Network Criticality League Table

Channels	Criticality (1-100)	
	Cable	Local
Gen 52-GP-9401.1 L1	18	24
Gen 52-GP-9401.1 L2	25	25
Gen 52-GP-9401.1 L3	47	24
Gen Circuit Breaker L1	21	24
Gen Circuit Breaker L2	16	24
Gen Circuit Breaker L3	25	25
Transformer 15 kV Input L1	47	24
Transformer 15 kV Input L2	21	24
Transformer 15 kV Input L3	25	26
110 kV GIS Bus L1	0	0
110 kV GIS Bus L2	28	26
110 kV GIS Bus L3	16	24

Condition/Action Guideline	Criticality (0-100)
High PD / Diagnostic	76-100
Moderate to High PD / Investigate	51-75
Moderate PD / Monitor	26-50
Plant OK / No Action	0-25

Key
● Cable / Machine PD Activity
■ Local PD Activity

Monitoring Period
 Last Hour Last 24 Hours
 Last Week Last Month

Generator
52-GP-9401.1



Generator
Circuit
Breaker



Transformer
52-TFR-9401.1
15 kV / 115 kV
157 MVA



110 kV GIS Bus
52-HDB-3301

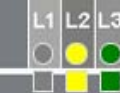

Transformer 15 kV Input L3	
L3	26
Cable	26
Local	26

Network Options

View Level	
	GEO : TCO Overview
	SLD : TCO Overview
	Substation : TGTS4
	Gen 52-GP-9401.1
TGTS4 Locations	
	Gen 52-GP-9401.1
	Gen 52-GP-9401.2
	Gen 52-GP-9401.3
	Gen 52-GP-9401.4
Sensor Configuration	
Monitor Configuration	
PD Measurements	

Analysis / Reports ▾

Substations / Network Selection

Local Area Network
Criticality League Table

Substations	Criticality (0-100)	
	Cable	Local
OHL L180 to 3GP	78	12
OHL L154 to KEGOC	06	52
OHL L171 to SGP	12	32
OHL L155 to KEGOC	08	27
OHL L156A to NPS	09	26
OHL L157 to CDS	20	21
OHL L156 to CDS	20	12
OHL L181 to 3GP	11	04

Condition / Action Guideline	Criticality (0-100)
High PD / Diagnostic	76-100
Moderate to High PD / Investigate	51-75
Moderate PD / Monitor	26-50
Plant OK / No Action	0-25

Key

- ID Circuit ID
- Cable / Machine PD Activity
- TEV Local PD
- Cable length

Monitoring Period

12/04/15 14:00 - 13/04/15 14:00

Live Last Week
 Last 24 hrs Last Month

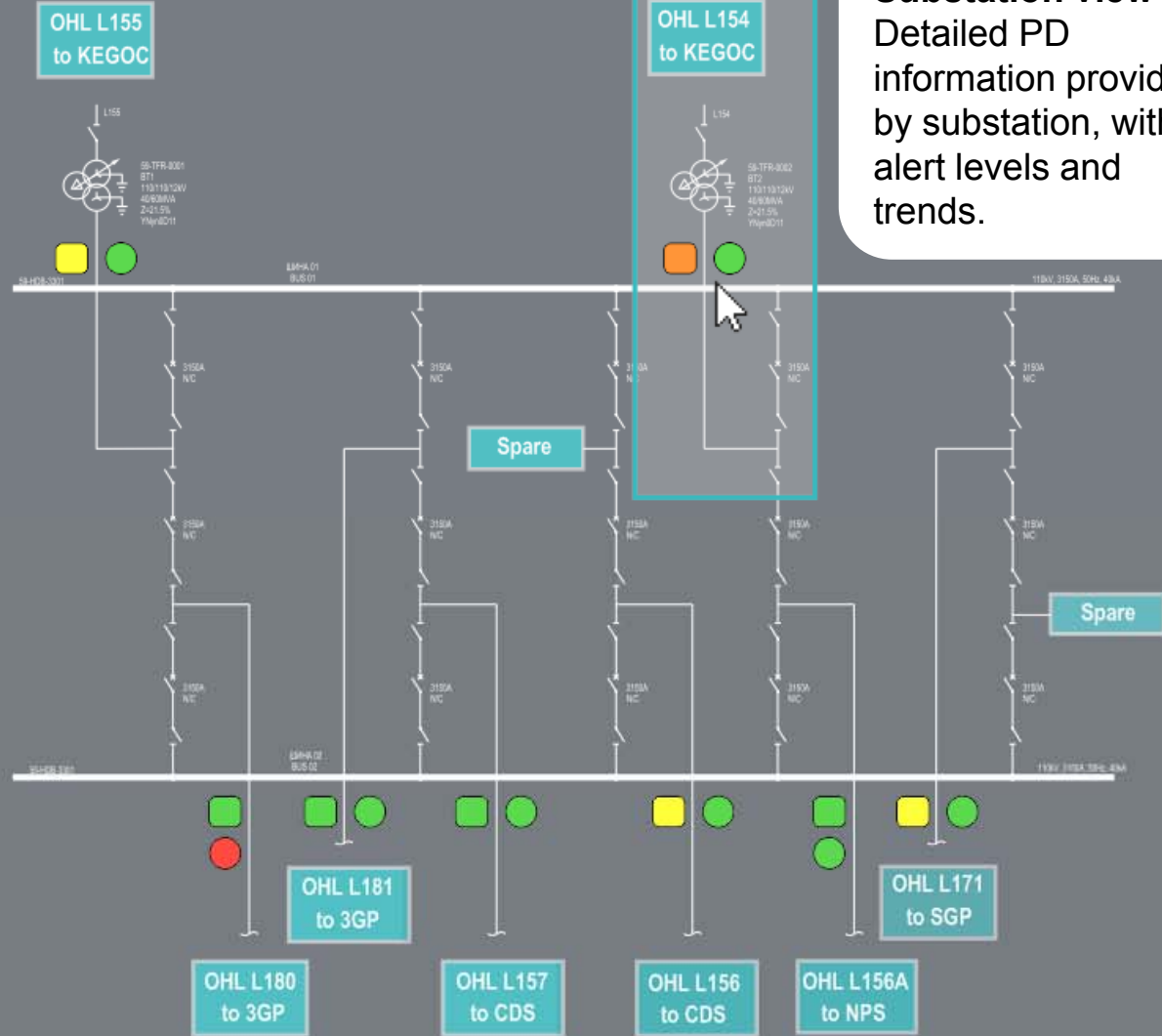

Network Selection

Network Options

View Level

- Site Overviews
- SLD Overlay**
- System Detail

TCO Tengiz Substations

- Core 110 kV
- Main 110 kV
- OGP 10 kV
- PBF 10 kV
- Utilities 10 kV

- Sensor Configuration
- Monitor Configuration
- PD Measurements

HVPD TCO Monitoring Database



Analysis / Reports PD Measurements

View	Result Types	Channels	Period	Auto
Chart Table Trend	Cable Local Noise	31, <input type="button" value="apply"/> <input type="button" value="tbl"/>	Last Week <input type="button" value="To"/> <input type="button" value=""/>	<input checked="" type="checkbox"/>

TCO, 21/01/2009 -

Cable (Gen 52-GP-9401.1 L1-Gen Cicuit Breaker L1)

Data not selected

Cable (Gen Cicuit Breaker L2-OL155 L3)

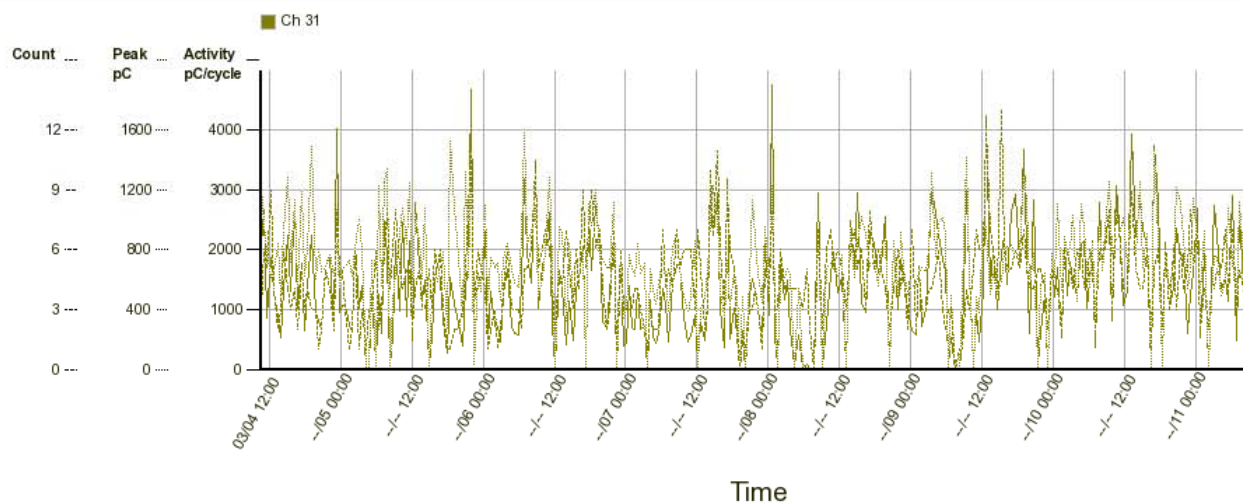

Local (Gen 52-GP-9401.1 L1-Gen Cicuit Breaker L1)

Data not selected

Local (Gen Cicuit Breaker L2-OL155 L3)

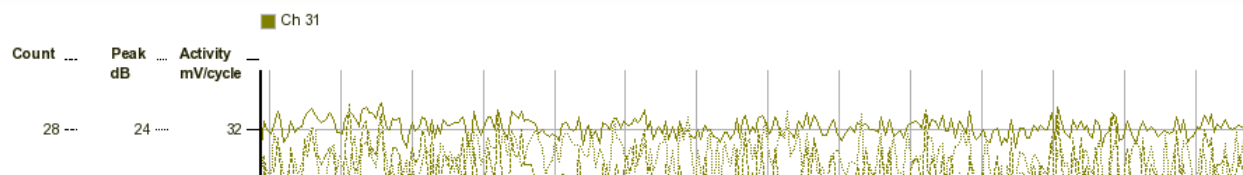

- Alongside the monitoring technology, HVPD also offer our clients an ongoing data monitoring and support service
- Technical support from HVPD engineers (via email/phone)
- Emergency response by phone on any identified incidents
- Monthly condition monitoring (CM) reports
- Diagnostic recommendations from the OLPD monitoring data, HVPD act as an external **Decision Support Centre (DSC)**
- Comparison and benchmarking of the OLPD activity in the HV network to the **HVPD OLPD Measurements Database**©
- Annual software upgrades and updates to the latest version of the HVPD OLPD Measurements Database©



PRESENTATION IV

On line Partial Discharge (OLPD) Testing and Monitoring of Variable Speed Drive (VSD) HV Motors



NOISE REDUCTION METHOD	ADVANTAGE	DISADVANTAGE	NOTES
1. Use a ' Twin-Coupler ' HVCC installation (2x HVCC sensors per phase) at the machine terminals	<ul style="list-style-type: none"> Can clearly distinguish interference from outside of the machine using Time-of-Flight (TOF) measurements with sensors separation down to 1.5m. The HVCC allows for a good reference signal of power frequency 	<ul style="list-style-type: none"> Compact termination boxes may not have space for the two HVCC's separated by a minimum of 1.5 m May still be hard to distinguish PD from VSD noise if the interference is large 	<ul style="list-style-type: none"> High sampling rate digitiser (>250 MS/s) is required to distinguish pulses with the correct accuracy. It is recommended that the 2x HVCC sensors are installed at the motor terminal box separated by a minimum of 1.5m
2. Use a ' Twin-HFCT ' installation (with 2x HFCT sensors per phase) at the machine terminal box or one at the machine terminal and the other at the VSD drive.	<ul style="list-style-type: none"> Can clearly distinguish interference from outside of the machine using Time-of-Flight (TOF) measurements with sensors separation down to 3m. 	<ul style="list-style-type: none"> Cable termination may not have space for two HFCTs, separated by 1.5 m Pulses don't have as sharp rise times on the HFCT sensor as they do on the HVCC sensors so distinguishing pulse start times is harder 	<ul style="list-style-type: none"> High sampling rate digitiser (>250 MS/s) likely required to distinguish pulses Higher bandwidth HFCT required to detect any fast rise times (of <10 ns) It is recommended where possible that the 2x HFCT sensors are installed at the motor terminal with a minimum separation of 3m
3. HFCT/HVCC with other 'gating' sensor	<ul style="list-style-type: none"> Assists in the cases where terminal boxes have only room for one HVCC coupler or HFCT sensor 	<ul style="list-style-type: none"> Gate sensor may be subject to more interference than machine windings 	<ul style="list-style-type: none"> Install position and type of gating sensor to be determined, RF antenna or HFCT on ground could be options
4. Hardware Filtering	<ul style="list-style-type: none"> Filter can be selected for the VSD interference pulses bandwidth Dynamic range of digitised maintained. 	<ul style="list-style-type: none"> Each VSD needs to be characterised for the best filter solution PD pulse shapes can be distorted by filters if they are not chosen carefully 	
5. Software Filtering	<ul style="list-style-type: none"> Software Filters can be selected for the VSD interference pulses bandwidth Easier to adjust filter design pose installation than with hardware. 	<ul style="list-style-type: none"> Possible loss of dynamic range on digitiser over hardware options Each VSD needs to be characterised for each filter – some 'training' required PD pulse shapes distorted by filter 	
6. Event recognition	<ul style="list-style-type: none"> VSD pulses can be characterised and discounted based on waveshape PD pulses can be characterised and identified based on waveshape 	<ul style="list-style-type: none"> Overlap of VSD and PD pulses not taken into account. Large magnitude/quantities of VSD pulses may make PD identification hard 	<ul style="list-style-type: none"> VSD/PD pulse overlap is of particular concern where machine windings are subject to very fast rise time VSD pulses that can degrade insulation.

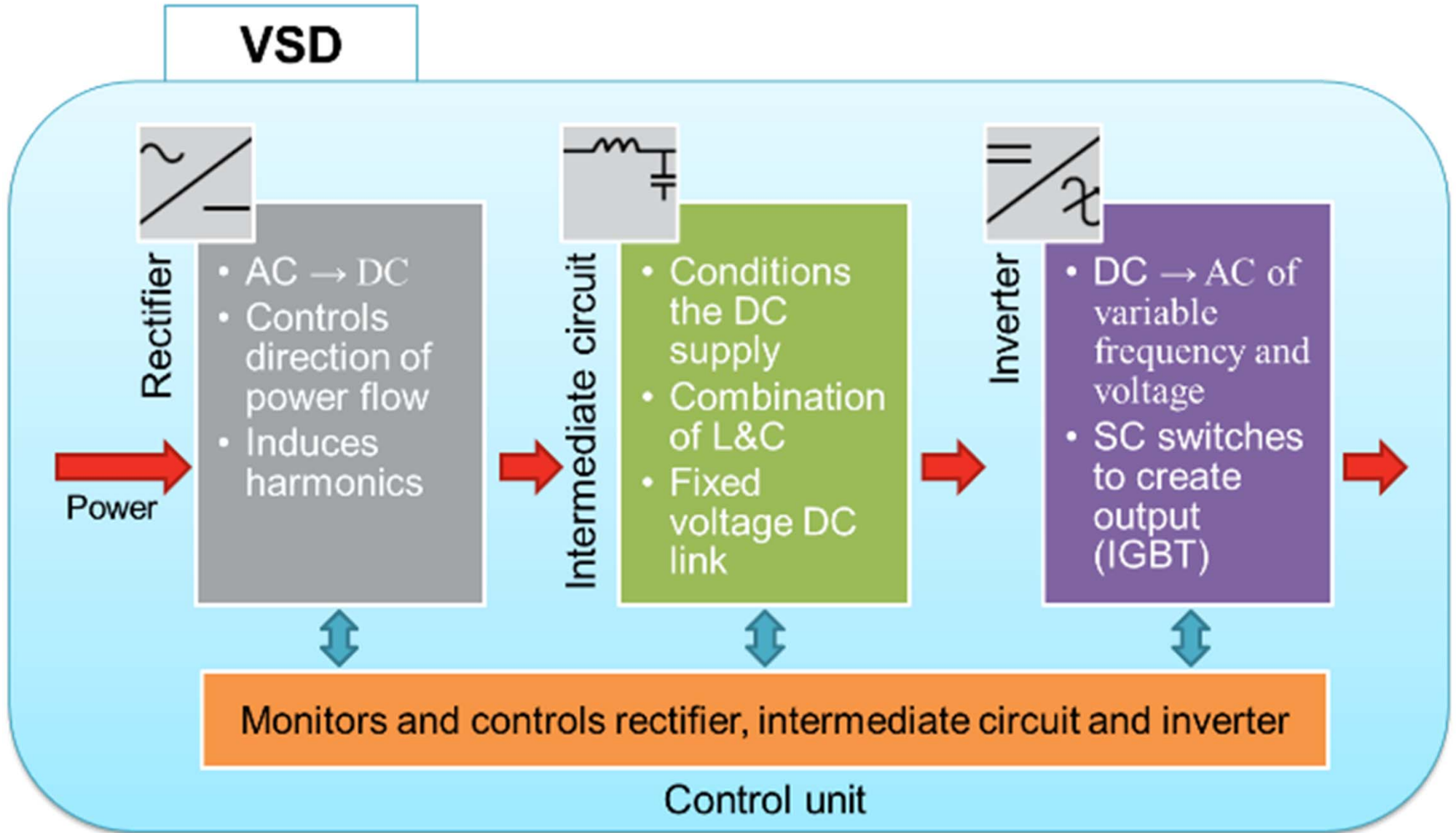

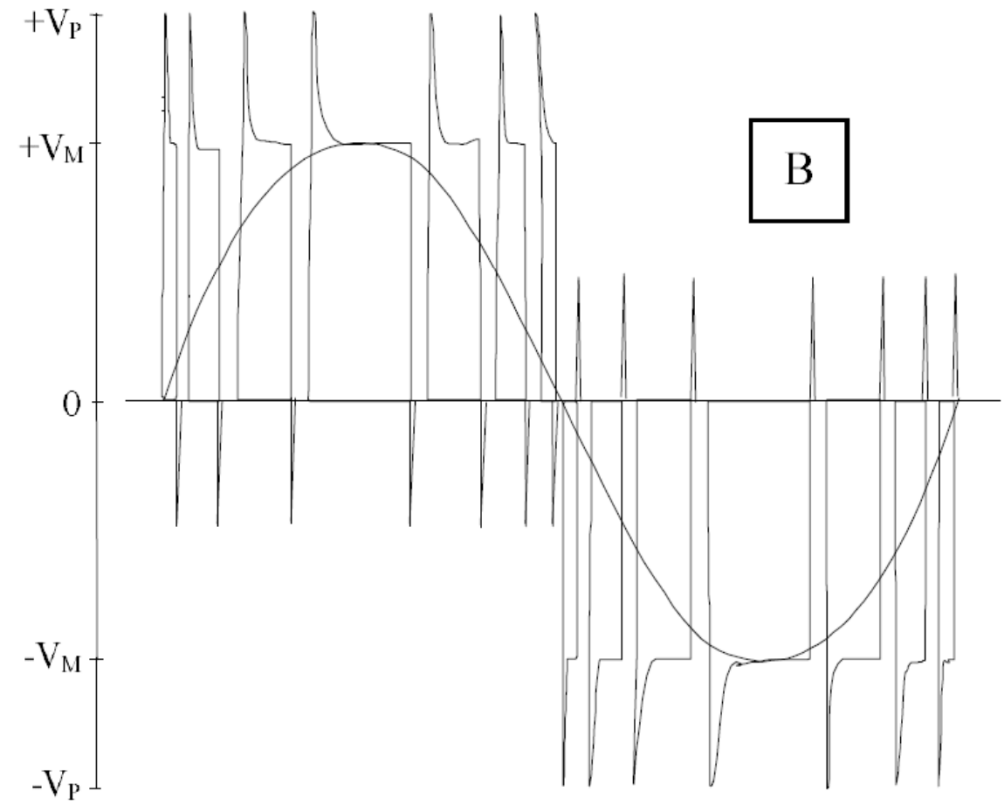
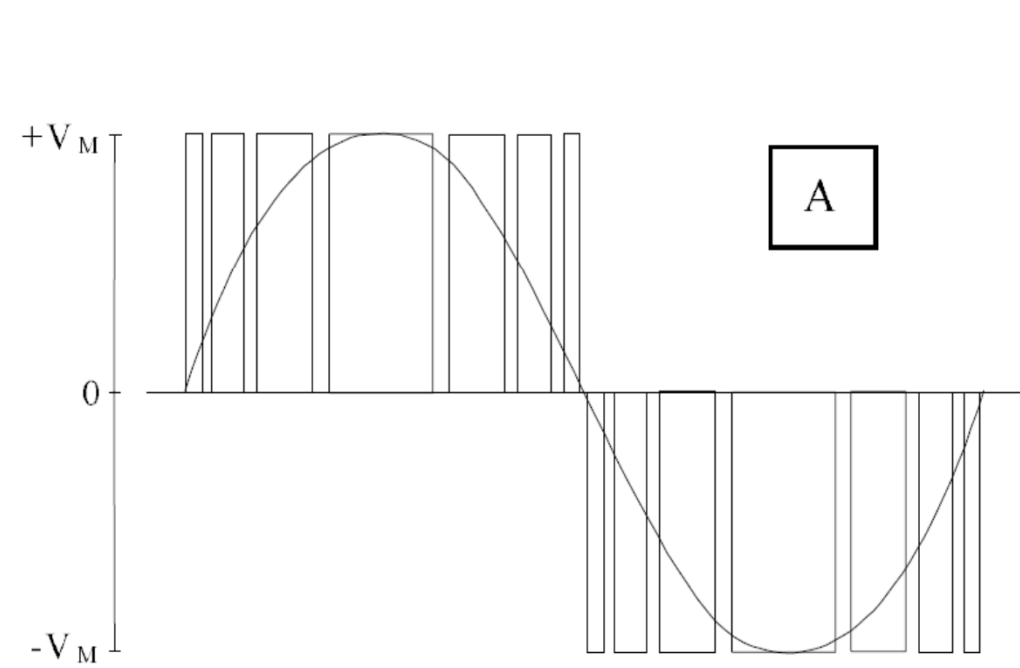

- HVPD's have experience with inverter-fed rotating machines from over 10 years of OLPD testing of in-service rotating HV machines.
- Designed to reliably measure partial discharge (PD) in the HV stator winding of VSD/ASD-fed machines, whilst discounting any high-frequency electromagnetic (E/M) 'noise' signals from the VSD switching electronics.
- The HVPD Sync™ OLPD Monitor, and a combination of hardware and software noise reduction techniques, including the use of a 'twin-sensor' monitoring approach with two sensors installed per phase to carry out 'precedence' pulse arrival measurements to discount VSD/ASD 'noise' from PD in the motor HV stator windings.

- Used to conduct pulse precedence measurements
- Compares the pulse's arrival times to the first and the second sensor (on the same phase).
- Locates the source of the PD to a particular item of plant item in the network (in this case the rotating HV machine's stator winding)
- Discounts the external E/M 'noise' (in this case from the inverter switching pulses from the VSD/ASD drive).

AT MACHINE

AT VSD

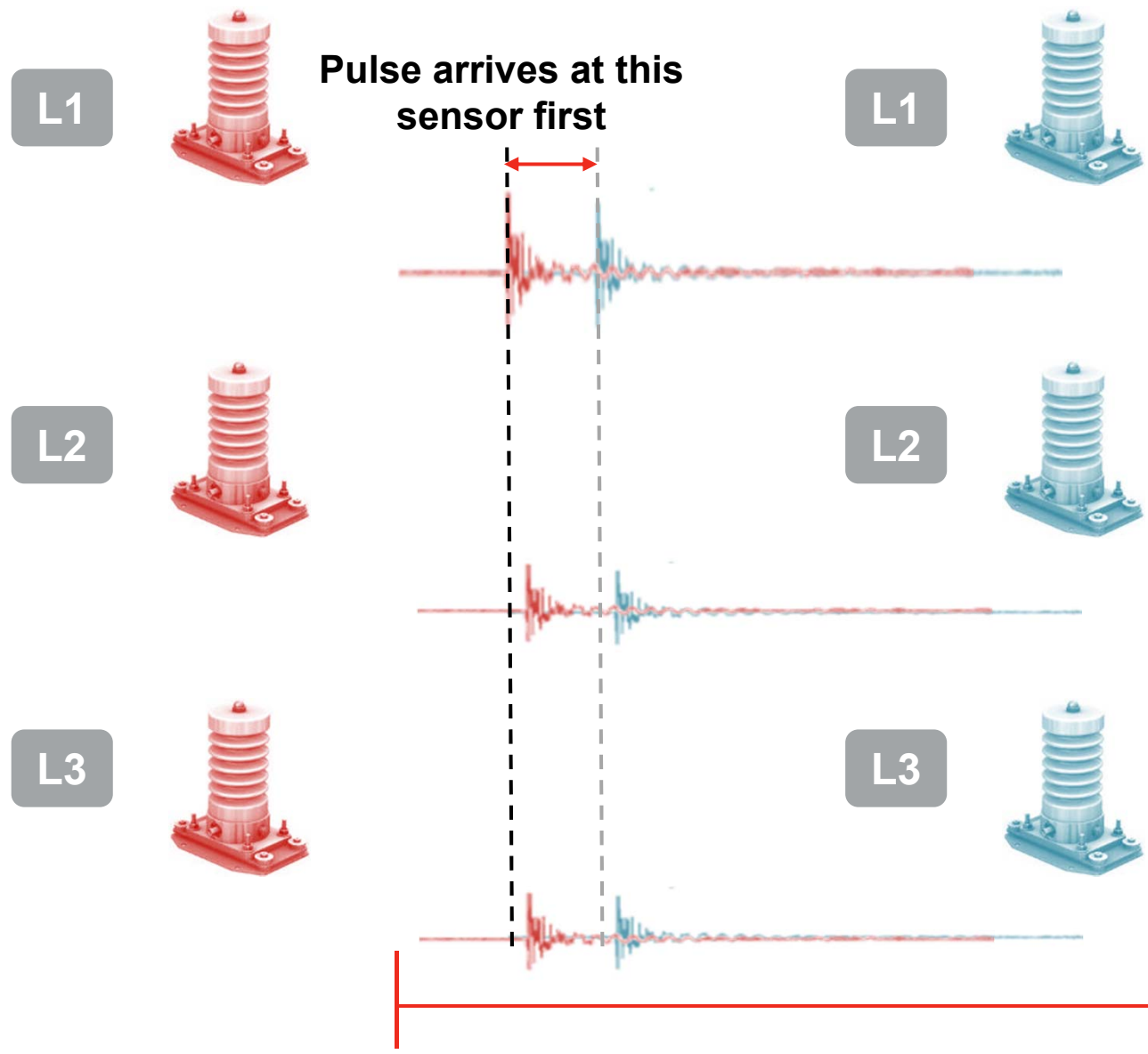

Relative signal arrival times and timings indicate source phase and direction



Multi Sync™ Installed between 2x adjacent Motors

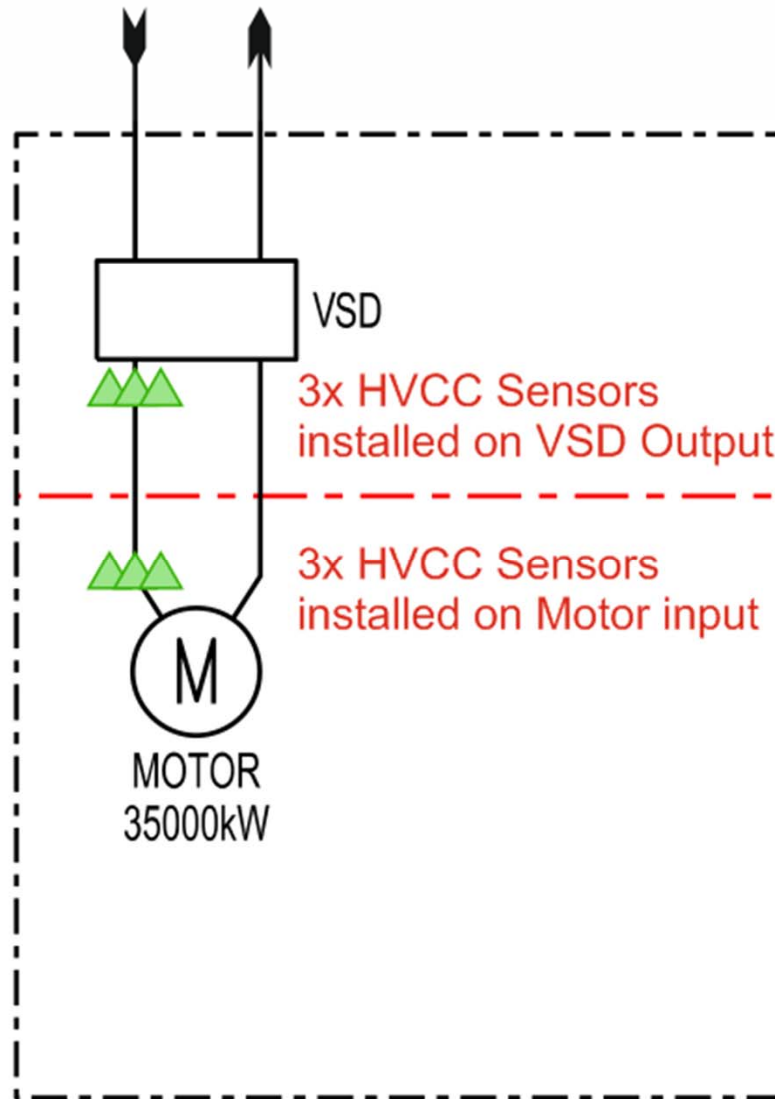

HVPD Sensor Configurations

	3x HVCC (1x per phase)
	HVPD Sync™ Monitor Unit

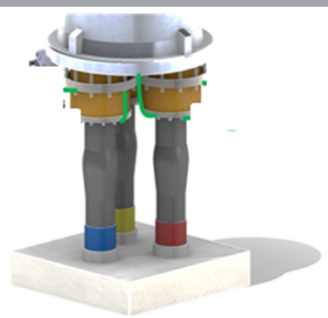

110 kV Cable Termination at GIS Substation



- HVCC Sensor

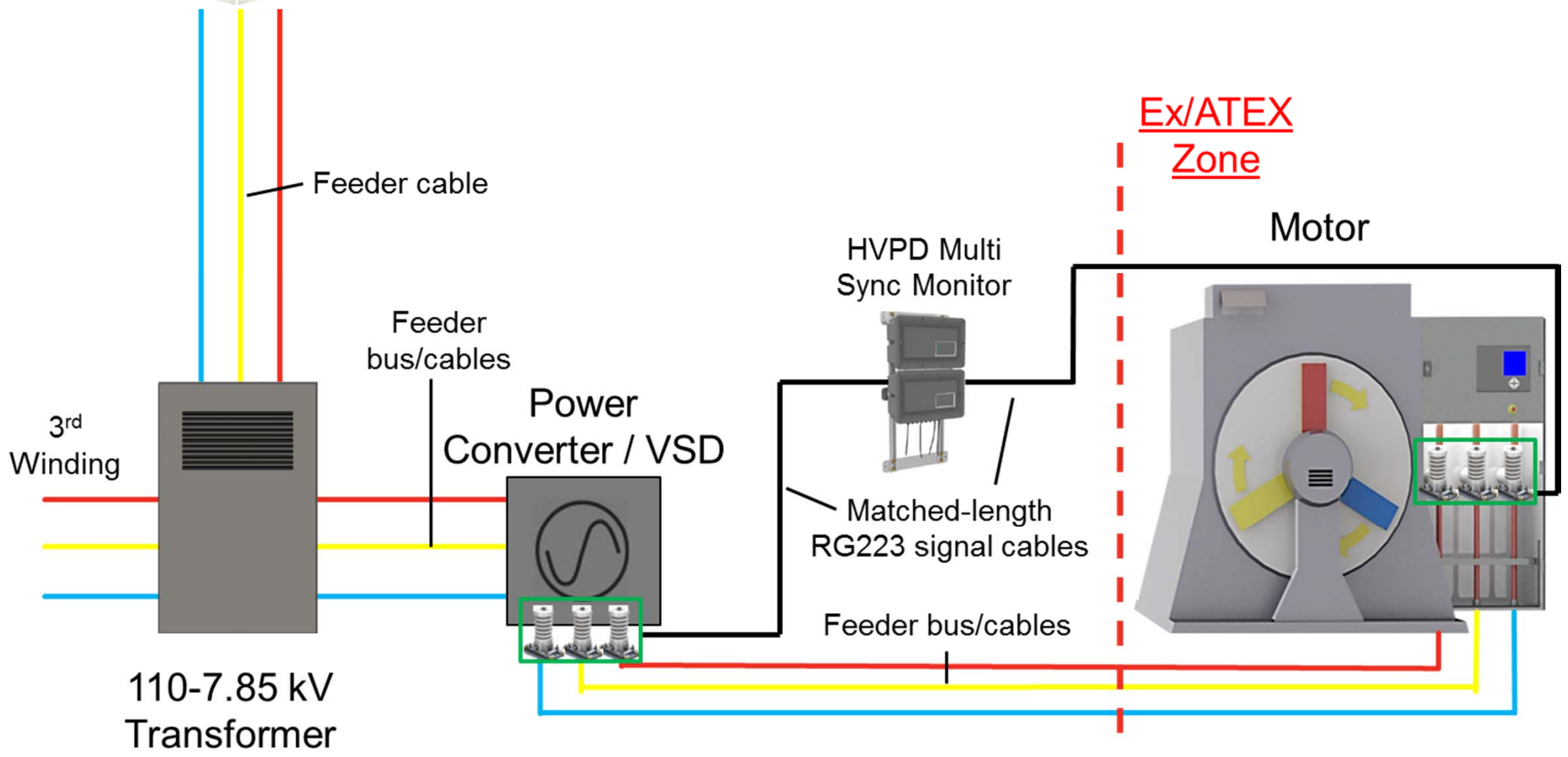

3rd Winding

Feeder cable

Feeder bus/cables

Power Converter / VSD

110-7.85 kV Transformer

HVPD Multi Sync Monitor

Matched-length RG223 signal cables

Feeder bus/cables



Ex/ATEX Zone

Motor

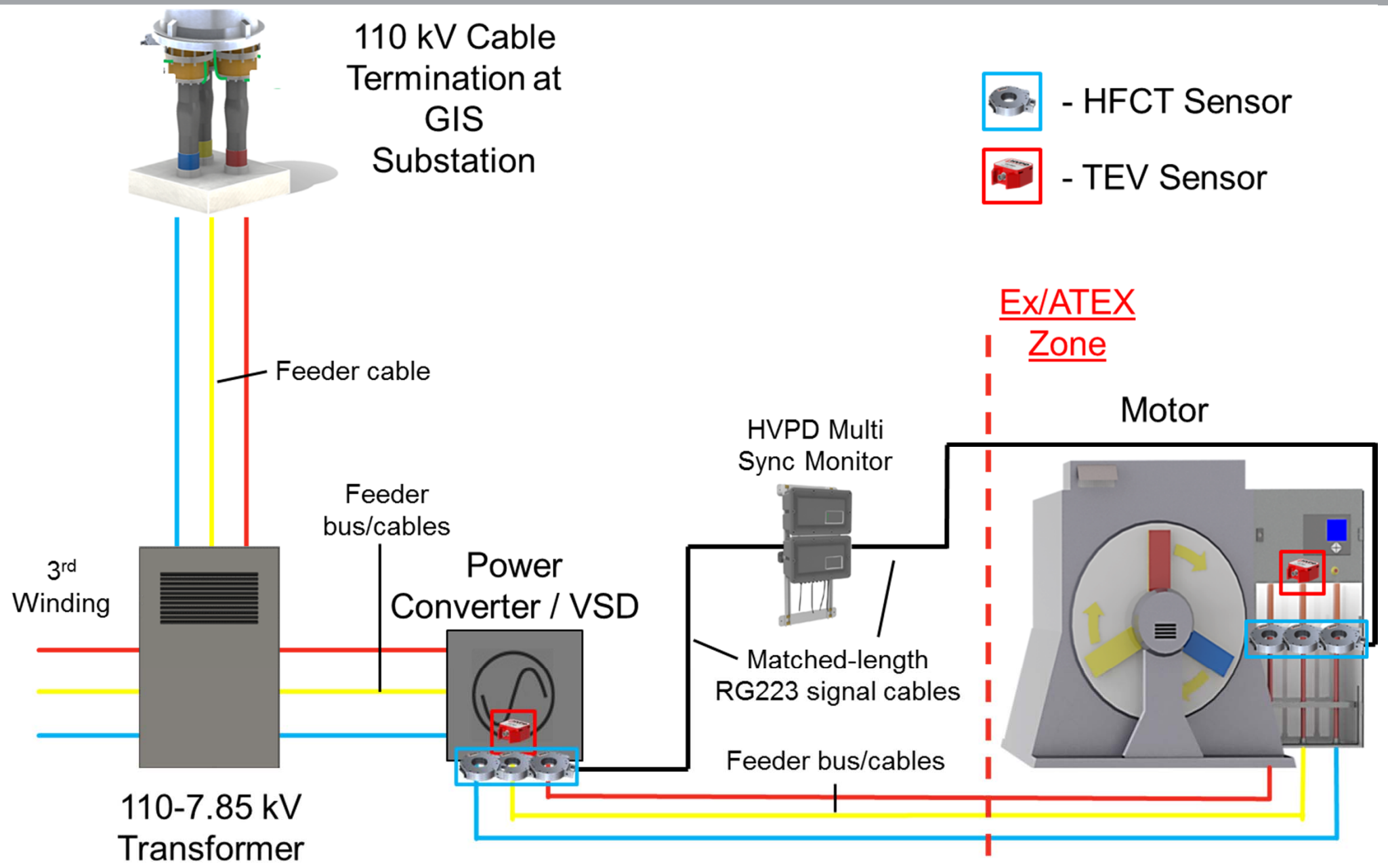
- The matched-length sensor coaxial signal cables are routed back to the HVPD Remote Terminal Unit (RTU) or HVPD Sync™ monitor.
- The monitor is located equidistant between the VSD drive and the motor.
- The direction of the origin of any pulse detected can be identified
- Any pulses detected first on the HVCC/HFCT sensors nearest to the VSD are discarded.
- Simultaneously, pulses arriving from the other direction, i.e. from the stator winding of the HV motor, can be captured and analysed by the HVPD Sync™ OLPD Monitor.



110 kV Cable Termination at GIS Substation

-  - HFCT Sensor
-  - TEV Sensor

Ex/ATEX Zone

Motor

3rd Winding

Feeder cable

Feeder bus/cables

Power Converter / VSD

HVPD Multi Sync Monitor

Matched-length RG223 signal cables

Feeder bus/cables

110-7.85 kV Transformer

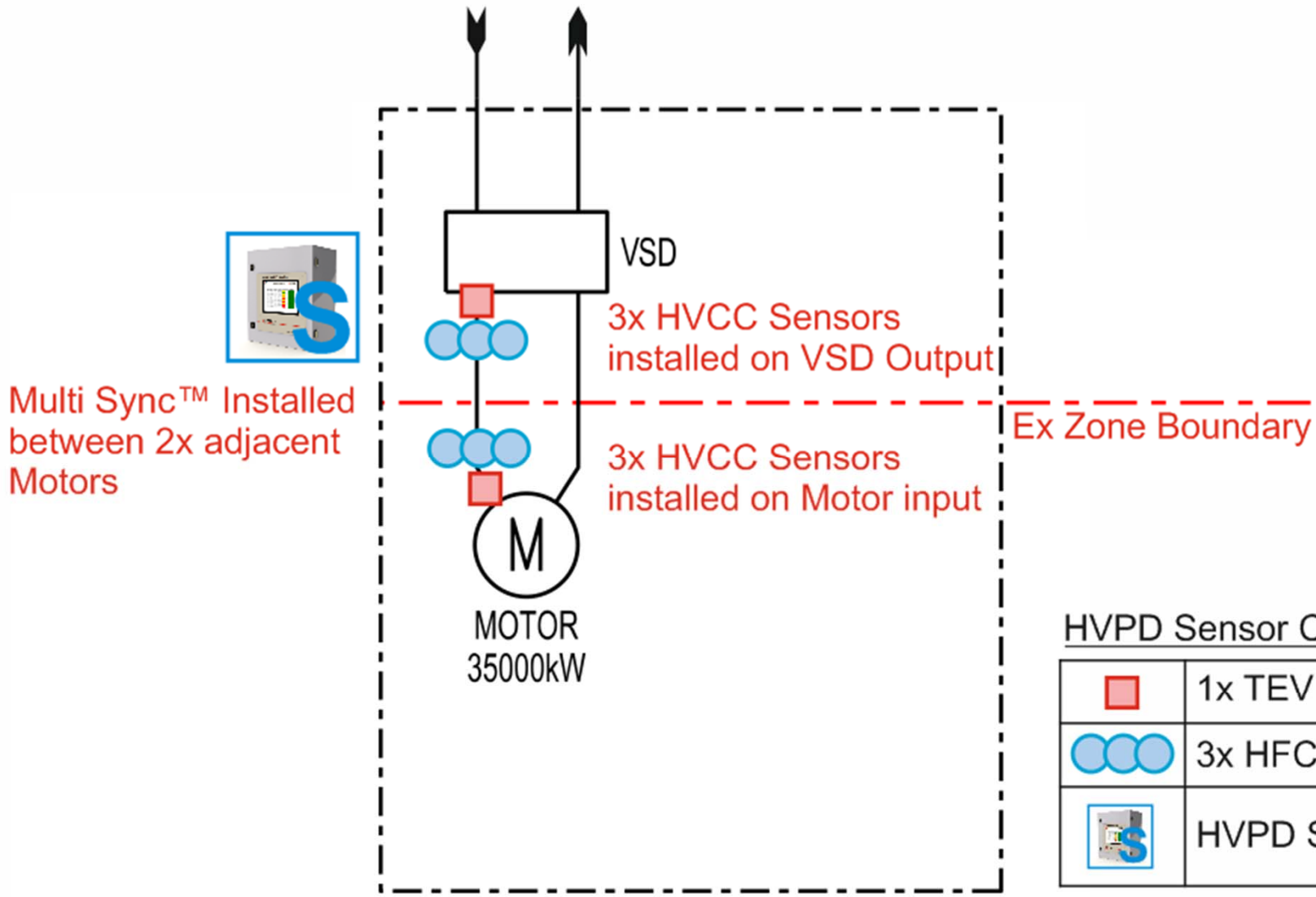

HVPD Sensor Configurations

	1x TEV
	3x HFCT (1x per phase)
	HVPD Sync™ Monitor Unit



- Continuous, centralised, remote OLPD monitoring of PD in switchgear, cables and rotating HV machines.
- 4x complete HV feeders (including the remotely connected HV plant) can be monitored by one monitor.
- Compatible with all types of OLPD sensors.
- IP65 Rated (Outdoor UBS shell), suitable for a wide range of applications and environments.
- Remotely accessible via Modbus TCP-IP, RS485, GPRS/3G modem or manual data download.
- Onboard automatic waveshape pulse analysis software provides differentiation of all PD pulses from 'noise'
- The system generates a 'PD Criticality' number from 0–100% through **comparison and benchmarking** with the **HVPD OLPD Measurements Database**©.

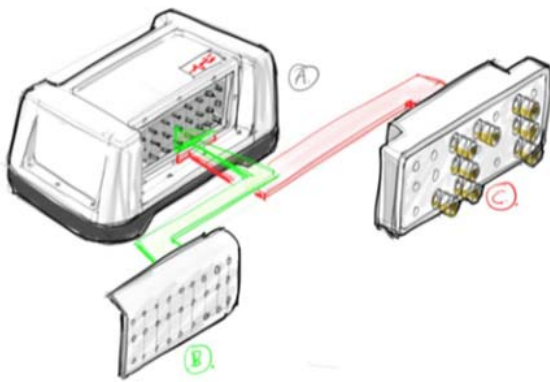

- 6-channel, synchronous data acquisition capability
- Measurements on all 6 channels can be made to within 5 ns of each other on all channels)
- Specifically designed for use with the HVCC 'Twin Coupler' or 'Twin HFCT' sets of sensors installed in the VSD drive and motor terminal boxes.
- Characterises and discards VSD pulses based on their wave shape while simultaneously characterising and identifying PD pulses.



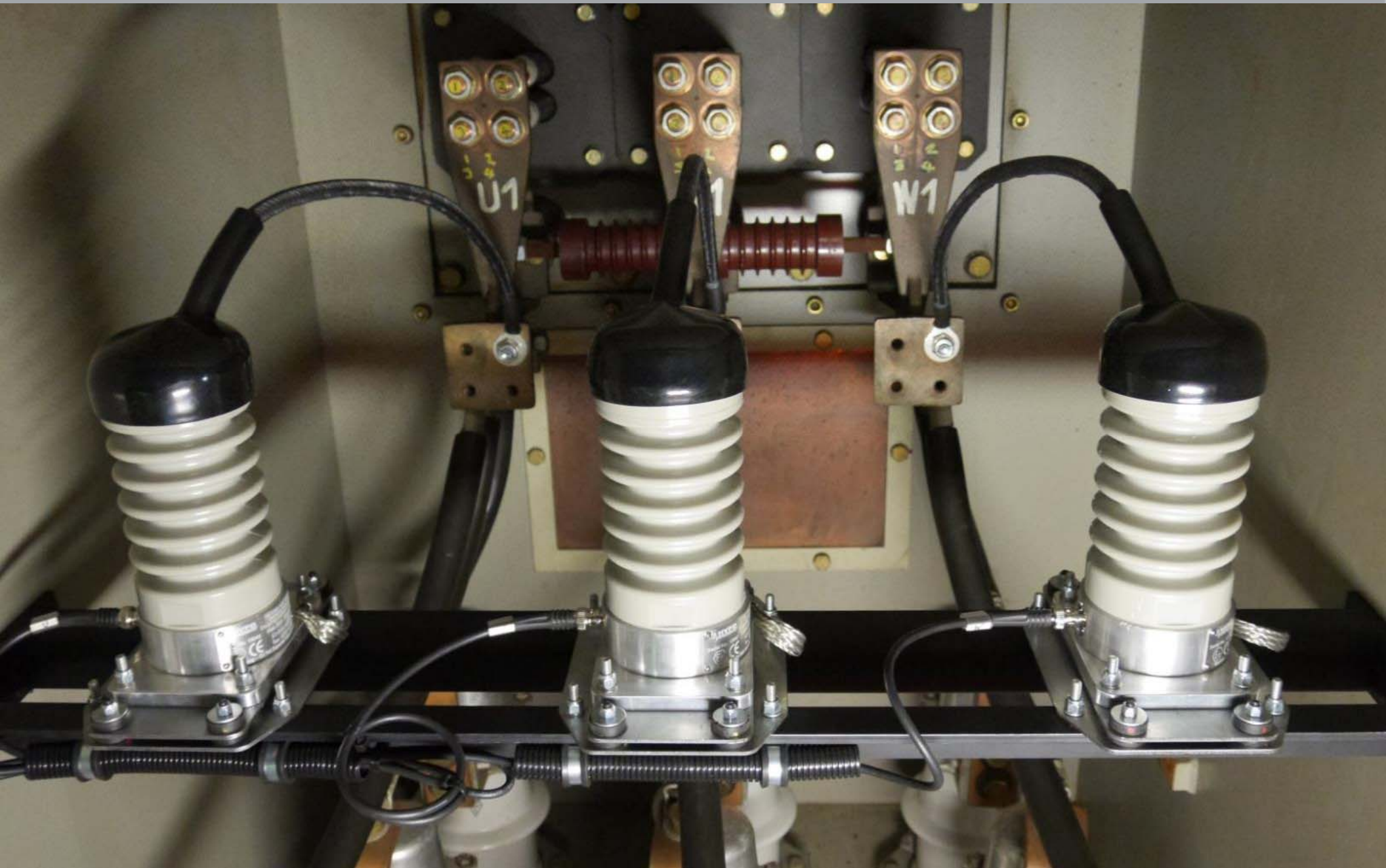

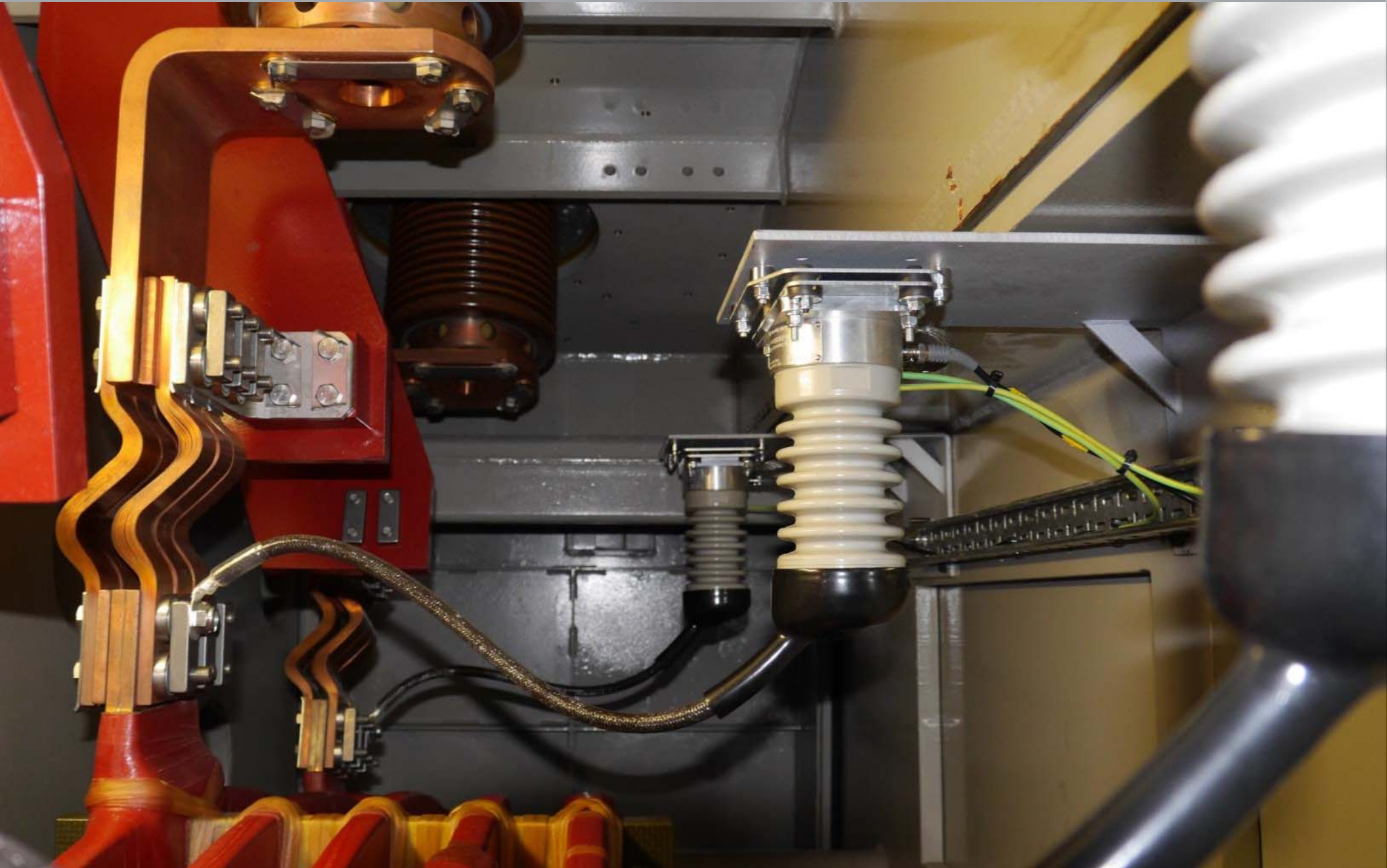

- The sensors and monitor arrangement shown can be used for HV cable lengths (from the VSD drive to the motor) of up to 100 m.
- The two RG223 co-axial signal cables from the VSD sensors and the motor cable box sensors would both be 50 m in length, this being the maximum length possible.
- The minimum separation between the ‘twin-HVCC’ sensors is a minimum separation of 2 m from each other
- The HFCT sensors require a minimum separation of 2.5 m (due to having a lower frequency response than the HVCC sensors).
- These separations refer to the minimum required distances in the case where both sets of twin sensors are being installed in a single, large cable boxes (such as on a large generator).

- The OLPD measurements made by the sensors are conditioned by a number of hardware and software filter modules that are selected according to the bandwidth of the VSD interference.
- Hardware filters cannot distort the shape of the PD pulses and/or completely remove the PD pulses themselves.
- The HVPD Sync™ OLPD Monitor also uses a number of software filters that are both flexible and adaptive since their cut-off, notch or band-pass frequencies can be adjusted after installation through remote communications and software upgrades.
- HVPD strongly recommend that a preliminary *desktop engineering study* is made of the details of the VSD-driven motor, including cable box drawings, details of the VSD system, etc.
- Baseline measurements of the E/M noise present in the circuit should also be carried out during the commissioning of the monitor in order to select the correct hardware filters. The monitor then undergoes a 30–60 day ‘training period’ where remotely-programmed, adaptive software filters are adjusted to remove any E/M noise sources on the network *whilst preserving the PD pulses*.

- Ex/ATEX-rated OLPD sensors termination boxes and suitable cable glands must be used.
- HVPD supply Ex/ATEX rated versions of HVCC sensors and HFCT sensors.
- These sensors are permanently installed inside the VSD and motor HV cable / bus compartment (one per phase)
- BNC signal connections are brought out to an external sensor connection box on the side of the motor and then outside of the Ex/ATEX zone through suitable Ex/ATEX signal cable glanding, as specified by the client.



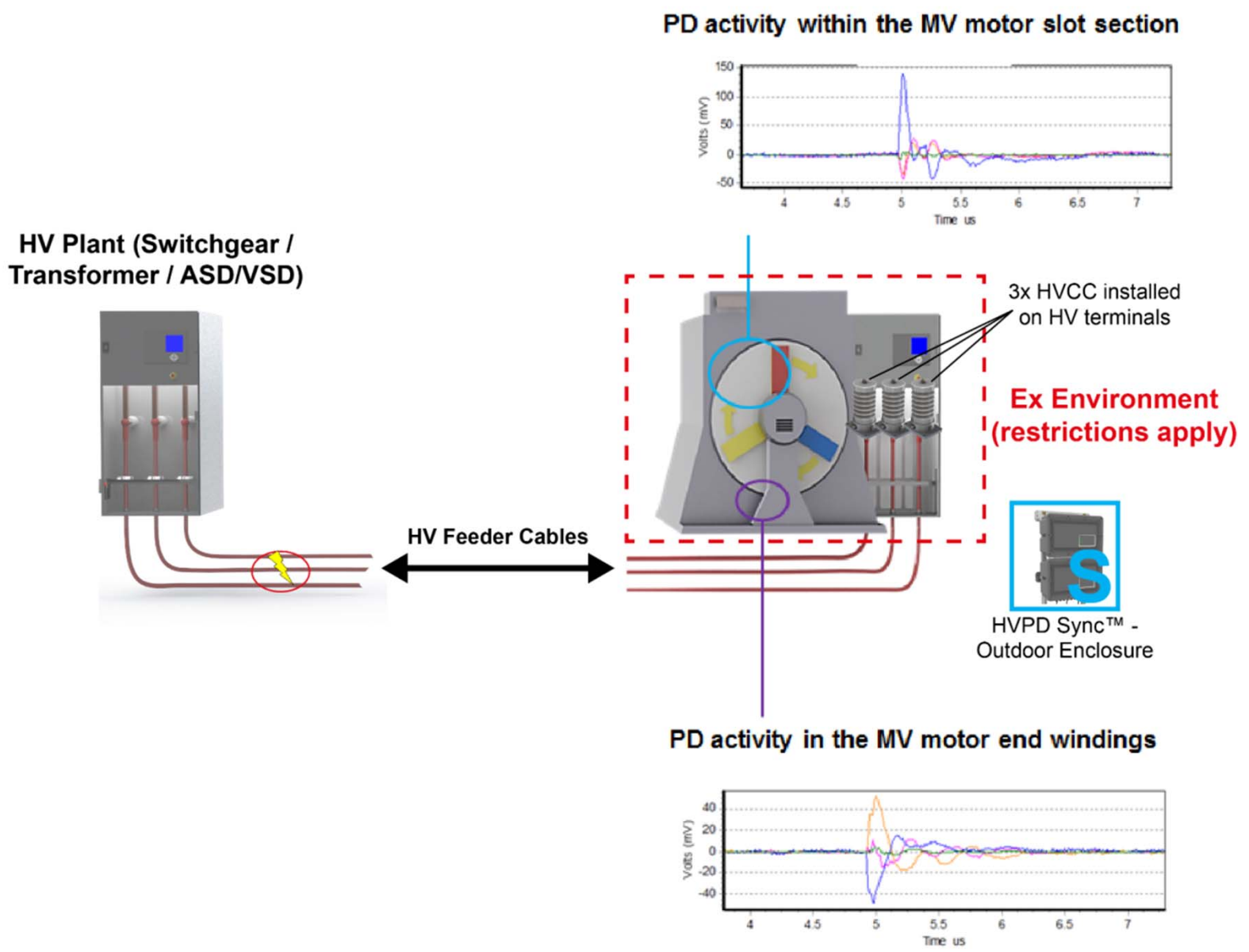

- Reliably measure PD in the HV stator winding of VSD machines
 - System discounts high-frequency, EM signals from the VSD switching electronics.
 - Achieved by a combination of hardware and software VSD noise reduction techniques,
- HVPD's solution employs '*Twin-Coupler*' HVCC sensors installed at the *minimum distance of 1.5 m from each other* in the machine's cable box. Alternatively, '*Twin-HFCT*' sensors can be used although these must be installed at a *minimum distance of 3 m from each other*.
- Hardware and software noise filters, combined with pulse 'precedence' measurements from the twin sensors to provide a robust system to discount any pulses that are received on the HVCC nearest to the VSD whilst preserving the PD pulses from the machine's stator winding that arrive first on this sensor.



PRESENTATION V

Case Studies from HVPD's recent OLPD Test and Monitoring Projects in the Worldwide Oil & Gas Industry





**Case Study I: OLPD monitoring of two 11 kV, 8.2 MVA
Generators on the FPSO Balder Vessel, Norway**

Generator	Reference	Manufacturer	Type	Rating (MW)	Voltage (kV)	Load I (A) <i>(From Name Plate)</i>	Year of Manufacture
Generator B	651-EG-01B	ABB	HSG 900XU10	8.2	11	430	1995
Generator C	651-EG-01C	ABB	HSG 900XU10	8.2	11	430	1995

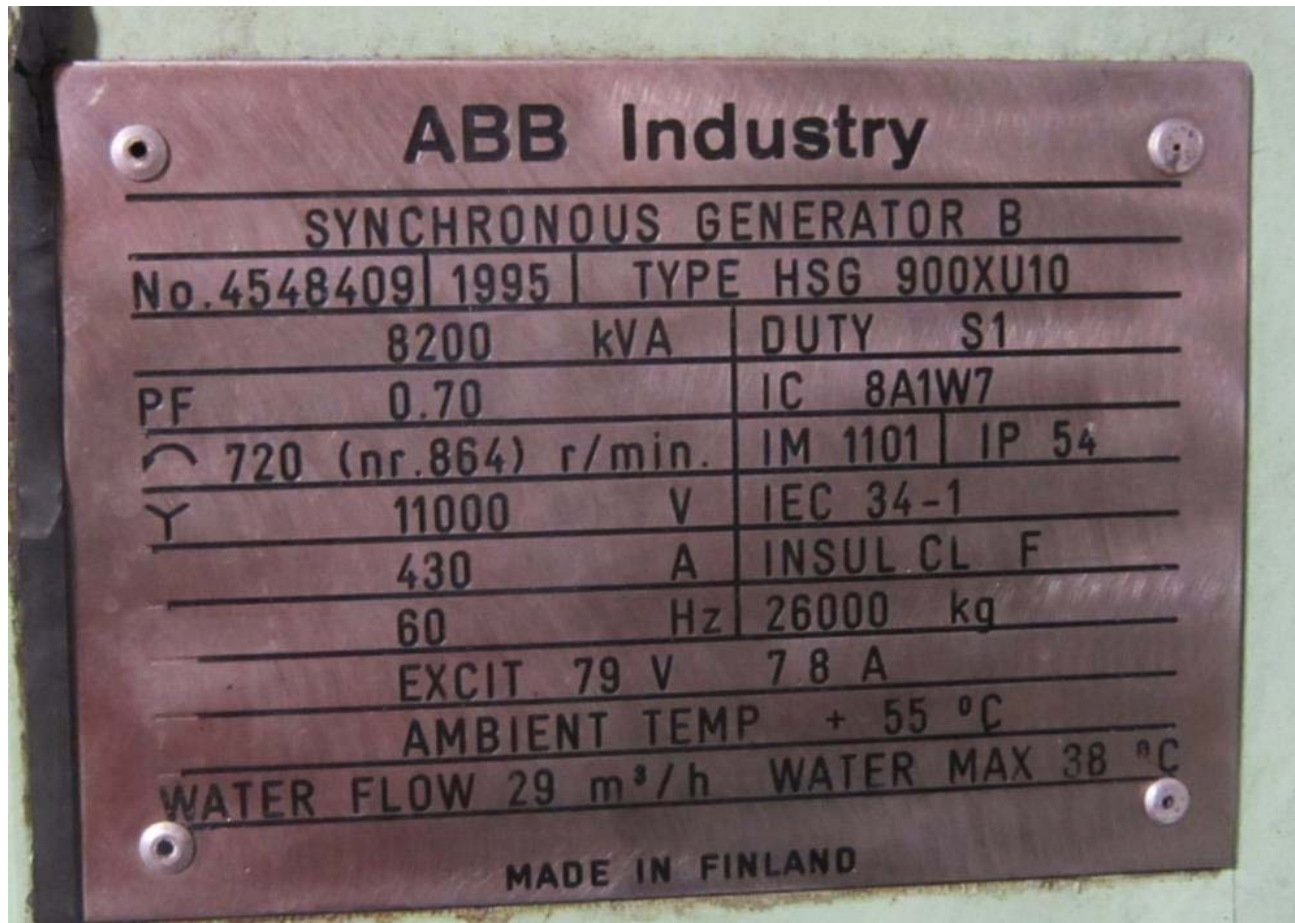



**HVPD Longshot™ OLPD Test System
at the 11 kV Switchboard**



**Portable HVPD Multi™ OLPD Monitor
at the 11 kV Switchboard**

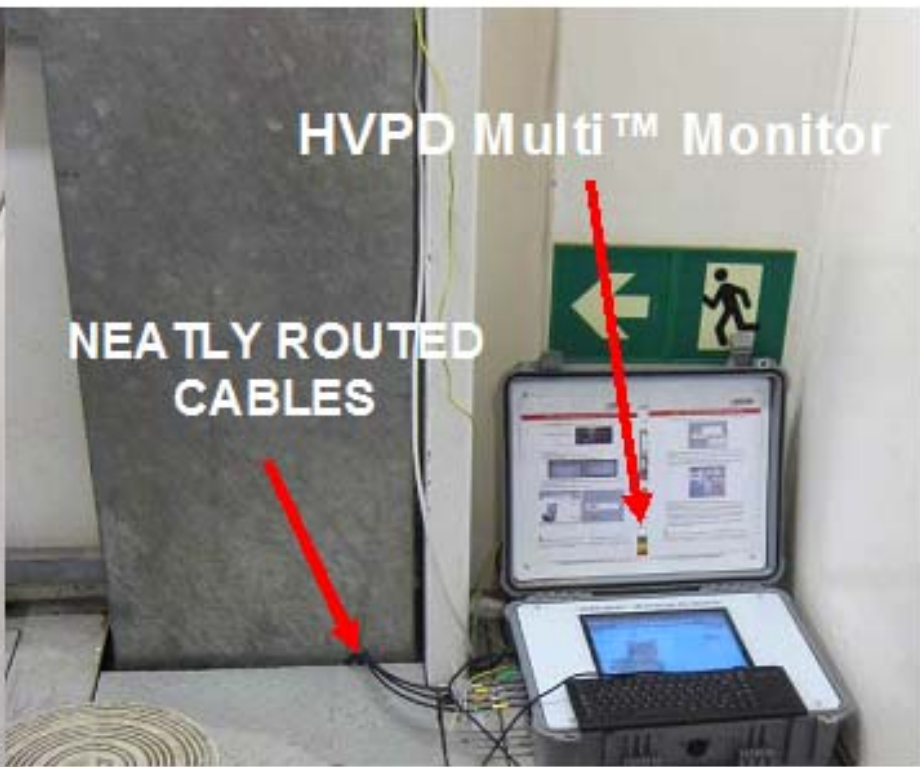
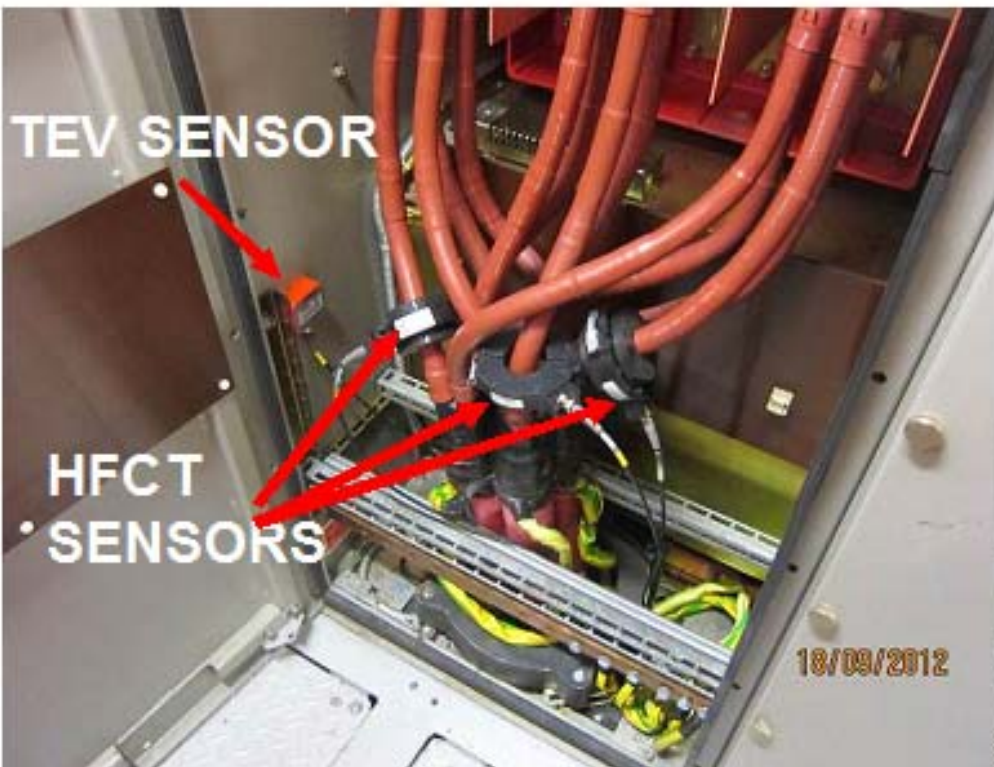



18/09/2012

Recommended IR and PI Values at 40°C (According to NEK410)	
IR	> 3,6 MΩ
PI	> 2,0

Plant / Reference	Phase	Q _m (Peak PD) (nC)	Q _{app} (Avg. PD) (nC)
Generator B 651-EG-01B	U	55.7	55.7
	V	32.3	32.3
	W	30.2	30.2
Generator C 651-EG-01C	U	30.2	30.6
	V	34	34
	W	33.8	33.8

Spinning	Q_m	Q_{app}	Frekvens	LLD	Num gain	HWgain	Acq time
[kV]	[nC]	[nC]	[Hz]	[%]			[s]
6,4	55,7	55,7	61	2	1	1	30

Phase U1: **High PD Levels** (up to 55.7nC)

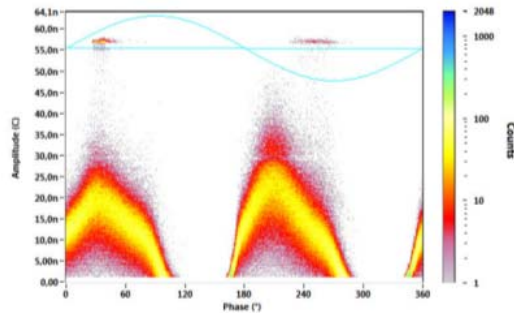

Spinning	Q_m	Q_{app}	Frekvens	LLD	Num gain	HWgain	Acq time
[kV]	[nC]	[nC]	[Hz]	[%]			[s]
6,4	32,3	32,3	60	2	1	1	30

Phase V1: **Medium-High PD Levels** (up to 32.3nC)

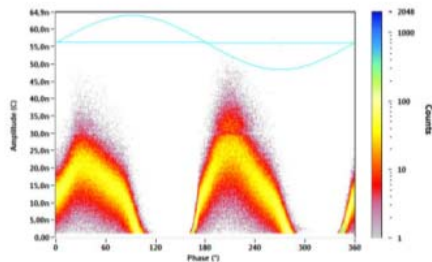

Spinning	Q_m	Q_{app}	Frekvens	LLD	Num gain	HWgain	Acq time
[kV]	[nC]	[nC]	[Hz]	[%]			[s]
6,4	30,2	30,2	60	2	1	1	30

Phase W1: **Medium-High PD Levels** (up to 30.2nC)

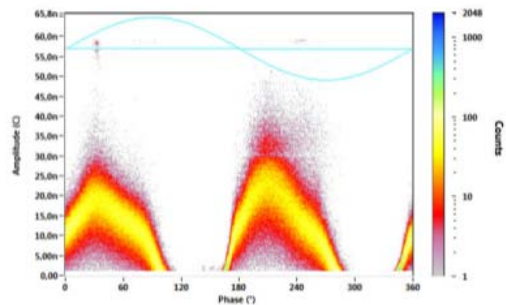

Conclusion: Generator B showed medium-high levels of PD activity (30.2 - 32.3nC) on two phases and **High PD levels (55.7nC) on Phase U1** during the off-line PD tests. **Recommendation:** carry out stator insulation repair, with particular focus on Phase U1.

Spinning	Q_m	Q_{app}	Frekvens	LLD	Num gain	HWgain	Acq time
[kV]	[nC]	[nC]	[Hz]	[%]			[s]
6,4	30,2	30,6	60	2	1	1	30

Phase U1: **Medium-High PD Levels** (up to 30.2nC)

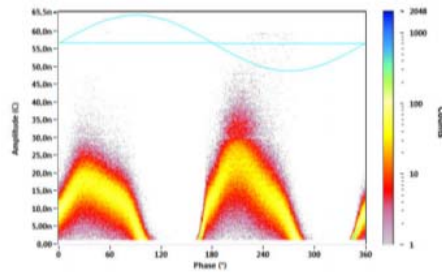

Spinning	Q_m	Q_{app}	Frekvens	LLD	Num gain	HWgain	Acq time
[kV]	[nC]	[nC]	[Hz]	[%]			[s]
6,4	34	34	60	2	1	1	30

Phase V1: **Medium-High PD Levels** (up to 34.0nC)

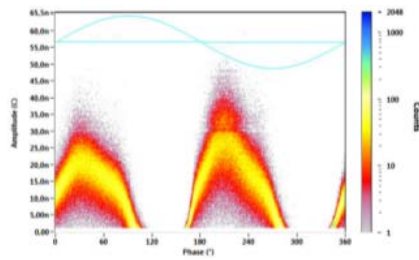

Spinning	Q_m	Q_{app}	Frekvens	LLD	Num gain	HWgain	Acq time
[kV]	[nC]	[nC]	[Hz]	[%]			[s]
6,4	33,8	33,8	60	2	1	1	30

Phase W1: **Medium-High PD Levels** (up to 33.8nC)

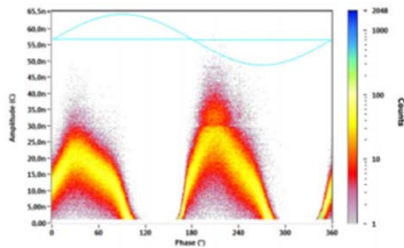

Conclusion: Generator C showed medium-high levels of PD activity (30.2 - 34.7nC) on **all three phases** during the off-line PD tests. **Recommendation:** carry out stator insulation repair .

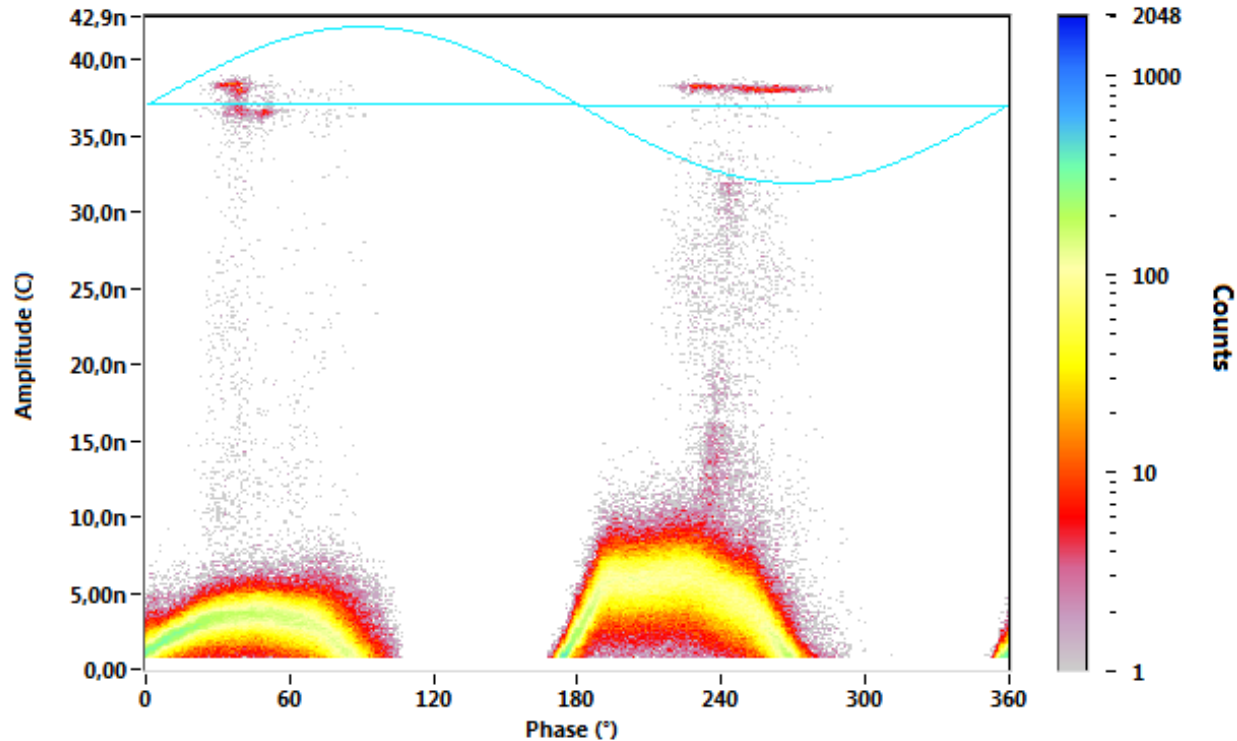

Guideline OLPD Levels for Rotating HV Machines (3.3 kV to 15 kV) – 31.12.2013		© HVPD Ltd 2013 all rights reserved
Condition Assessment	PD Peak Level (nC)	PD Activity (nC/cycle)
New/Excellent	<2.0 nC	<50
Good	2.0 – 5.0 nC	50 – 200
Average	5.0 – 10.0 nC	200 – 450
Still Acceptable - Monitor	10.0 – 20.0 nC	450 – 750
Probable Inspection	20.0 – 35.0 nC	750 – 1250
Problem / Unreliable	>35.0 nC	>1250

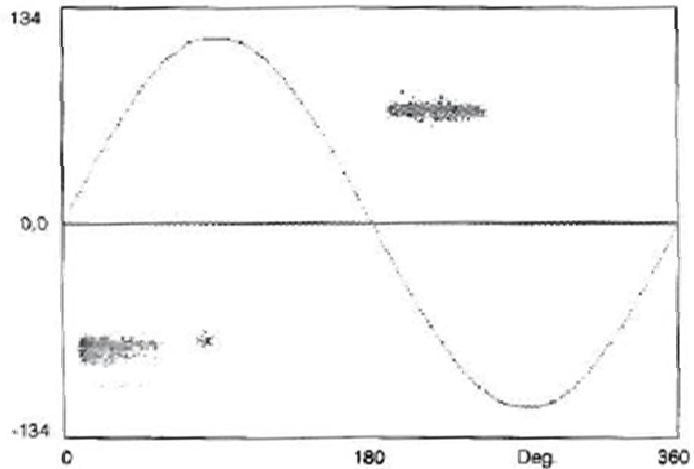

End-winding Partial Discharge - Type I

Gas type discharges between bars in the winding overhang or between a bar and the press finger of the core

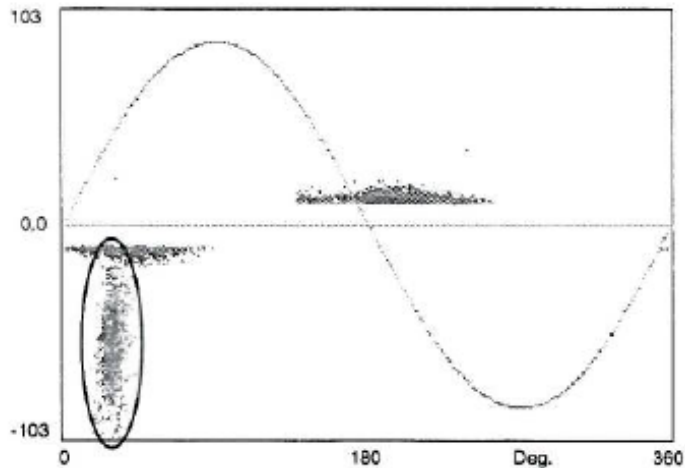

End-winding Partial Discharge - Type II

Surface discharges / tracking along the winding overhang due to contamination or poor stress control grading at the air / insulation interface

End-winding discharges

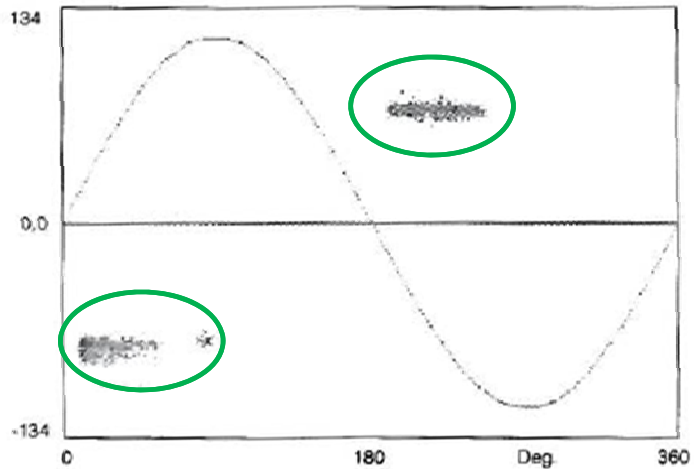

End-winding discharges

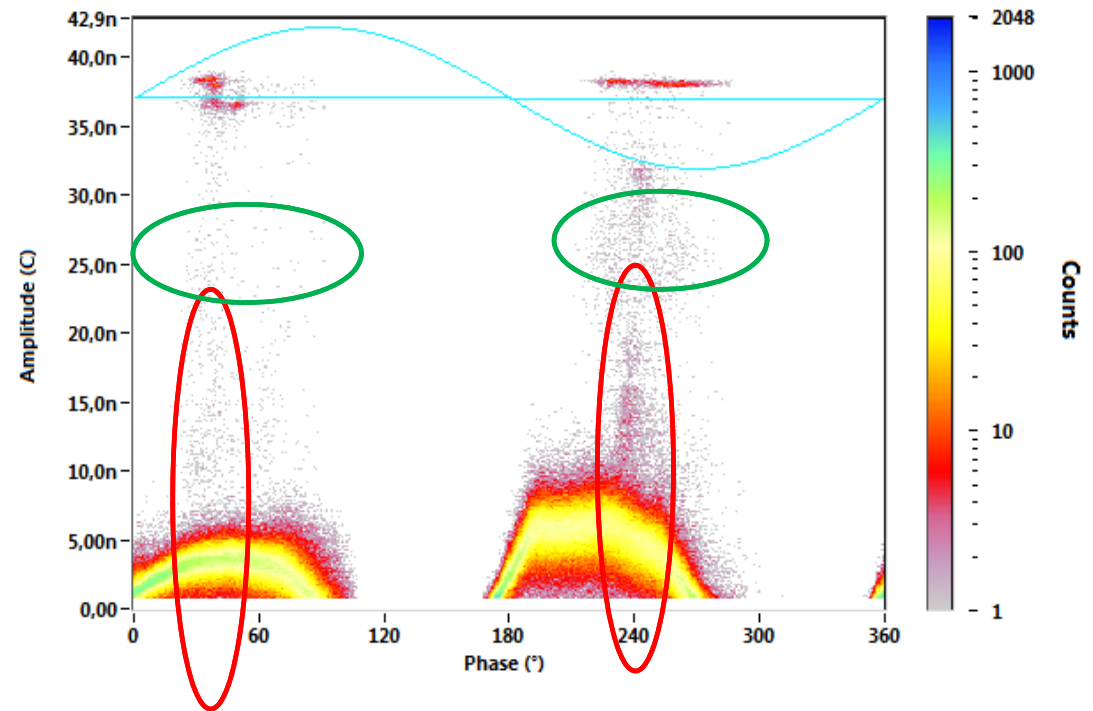
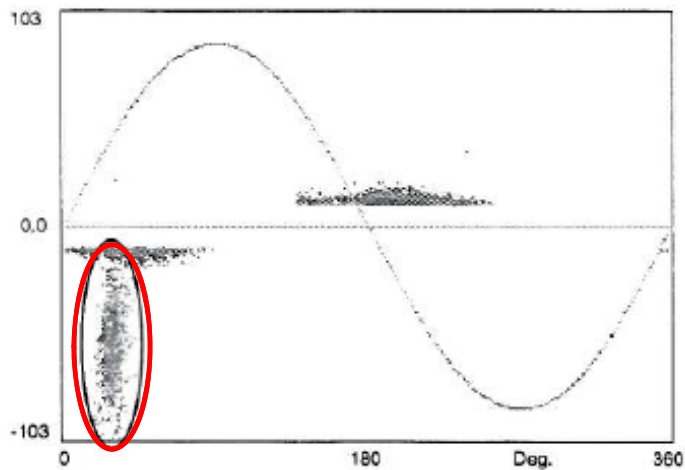

Conclusion: Generator B showed PRPD patterns for both Type I and Type II end winding discharges during the off-line PD tests.

Recommendation: carry out stator insulation repair with focus on the end windings.

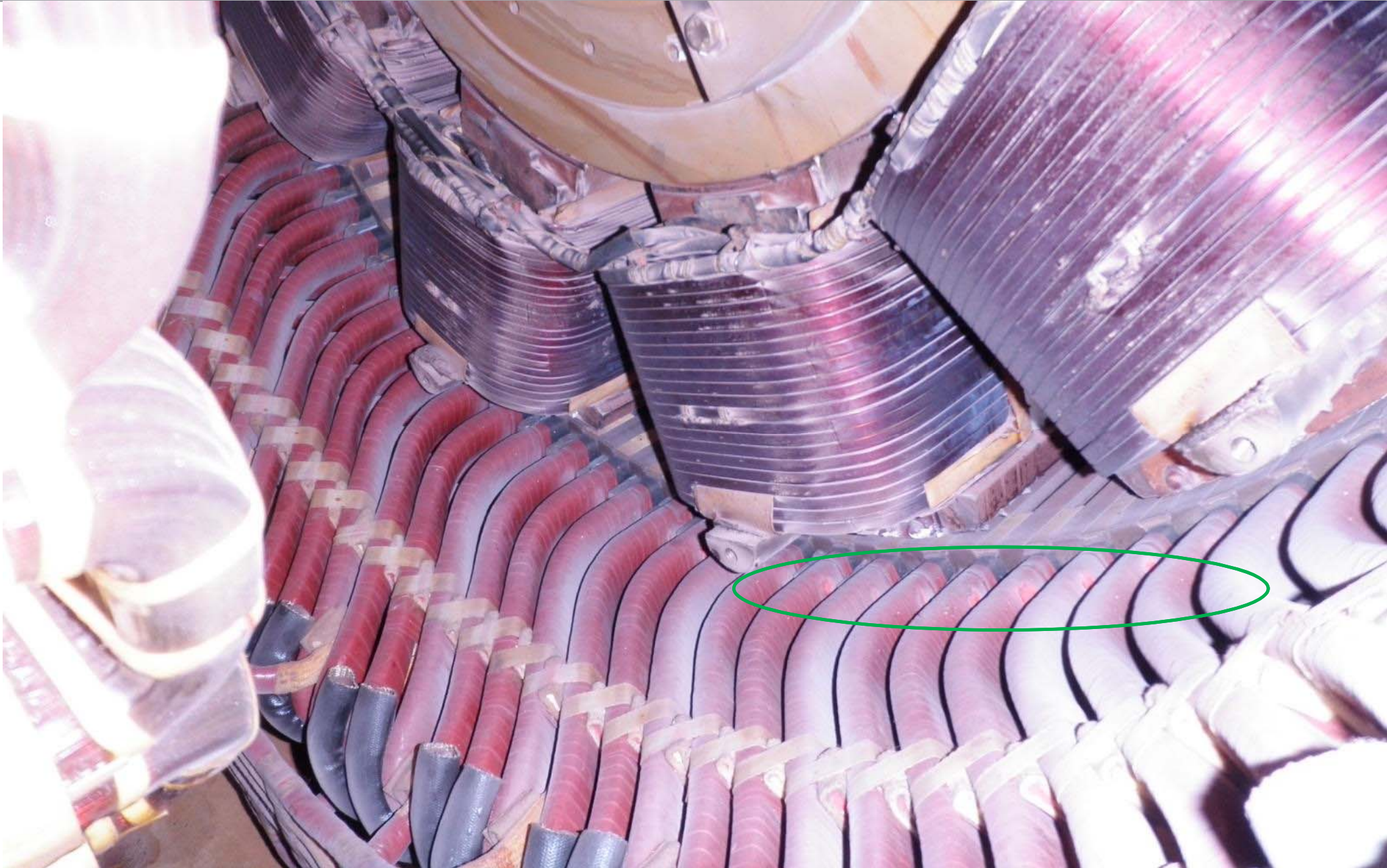

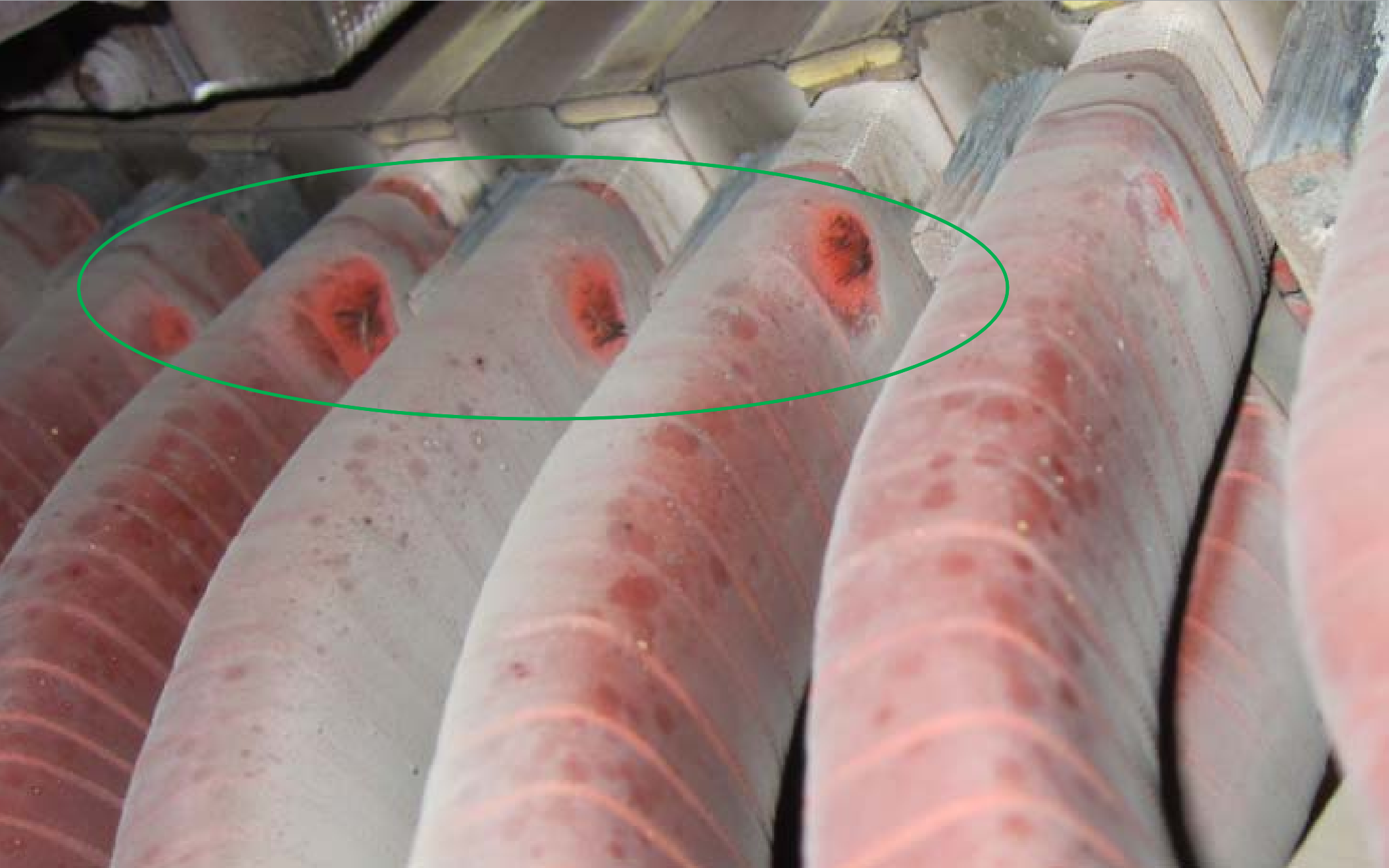





Plant / Reference	Phase	Peak (nC)	Activity (nC/Cycle)	Local (dB)	Overall Condition	Comments
Generator Load : 20%		Winding Temperature at the start of tests: 60-68°C				
Generator B 651-EG-01B	U	36.50	1220	0	Problem, Unreliable	Internal or Slot Discharges Monitor PD Levels Closely
	V	35.74	1025			
	W	26.33	969			
Generator C 651-EG-01C	U	19.51	570	0	Probable Inspection	Internal or Slot Discharges Monitor PD Levels Closely
	V	22.26	617			
	W	24.33	842			
Generator Load : 40%		Winding Temperature at the start of tests: 75-85°C				
Generator B 651-EG-01B	U	34.05	913	0	Problem, Unreliable	Internal or Slot Discharges Monitor PD Levels Closely
	V	28.20	917			
	W	52.91	936			
Generator C 651-EG-01C	U	22.06	393	0	Probable Inspection	Internal or Slot Discharges Monitor PD Levels Closely
	V	23.46	465			
	W	31.63	481			
Generator Load : 80%		Winding Temperature at the start of tests: 100 -110°C				
Generator B 651-EG-01B	U	39.03	1280	0	Problem, Unreliable	Internal or Slot Discharges Monitor PD Levels Closely
	V	42.26	1103			
	W	55.40	1077			
Generator C 651-EG-01C	U	24.52	787	0	Problem, Unreliable	Internal or Slot Discharges Monitor PD Levels Closely
	V	23.13	757			
	W	33.80	1110			

Plant Reference	Phase	On-Line PD Test Level (nC)			Off-line PD Test Level (nC)	
		20% Gen. Load	40% Gen. Load	80% Gen. Load	Q _m (Peak PD)	Q _{app} (Avg. PD)
Generator B 651-EG-01B	U	36.50	34.05	39.0	55.7	55.7
	V	35.74	28.20	42.3	32.3	32.3
	W	26.33	52.91	55.4	30.2	30.2
Generator C 651-EG-01C	U	19.51	22.06	24.5	30.2	30.6
	V	22.26	23.46	23.1	34.0	34.0
	W	24.33	31.63	33.8	33.8	33.8

Discussion: The results from the OLPD tests carried out by HVPD (of the in-service 11kV generators) concurs closely with the PD test data from the Karsten Moholt off-line PD tests.

Generator B is in the **‘Problem/Unreliable’ RED condition category** and **Generator C** is in the **‘Probable Inspection’ ORANGE condition category**.

- Following these measurements of high PD levels on Generator B from both the off-line and on-line PD tests, **Generator B was removed from service** on 19th October 2012 and sent to the repair factory to be re-wound.
- A **previously repaired generator** (of the same manufacturer and Type: HSG 900XU10 (ABB, 11 kV, 8.2 MVA) was installed in place of Generator B and went into service on 15th November 2012.
- It was found that the **replacement Generator B** had low and decreasing levels of PD when compared to the previous generator that was removed from service.
- This replacement generator had a stator winding insulation condition in the '**New/Excellent**' condition category.

HV Asset	Phase	OLPD Activity (nC/Cycle)	Standard Deviation (nC/Cycle)	OLPD Activity change rate (nC/Cycle)/(Month)	Avg PD Activity Increase Rate (%/Month)
Generator B	L1 (W)	790	78.03	8.81	1.59
	L2 (V)	760	60.16	-0.24	-0.04
	L3 (U)	400	51.87	33.81	32.00

L1 (Ch 09) Phase PD Activity (nC/cycle)

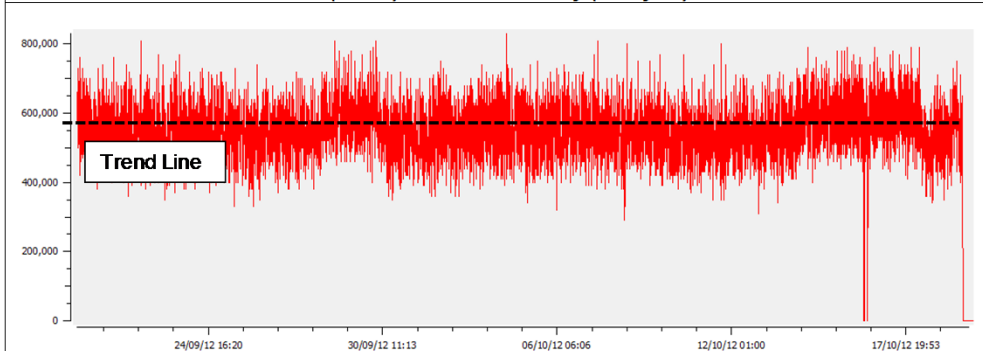

L2 (Ch 10) Phase PD Activity (nC/cycle)

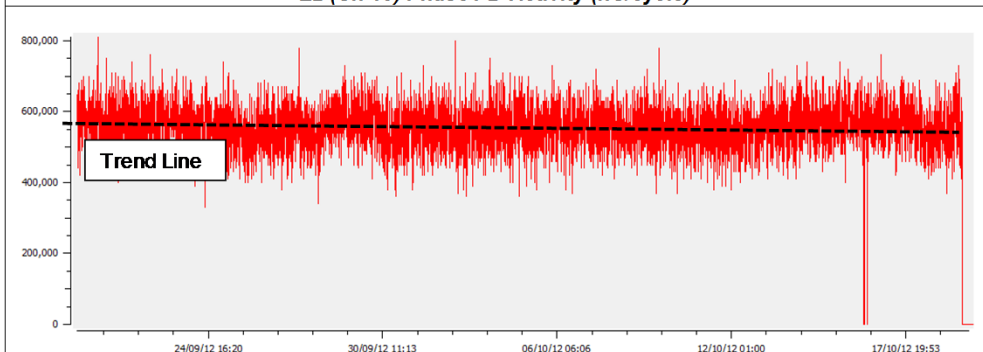

L3 (Ch 11) Phase PD Activity (nC/cycle)

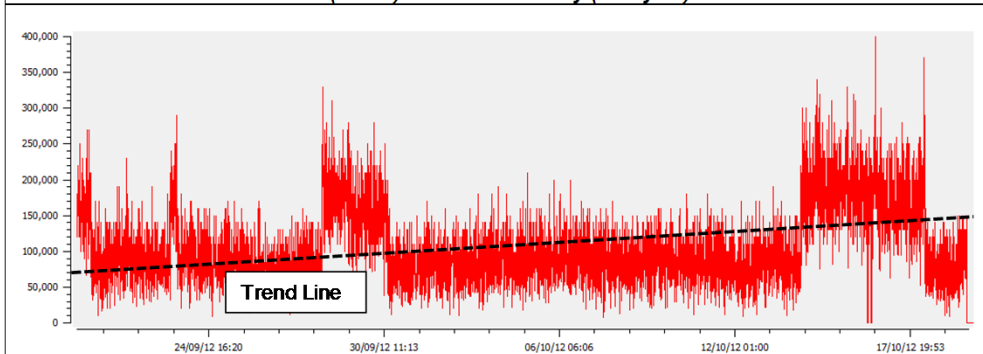

Note: rising OLPD Activity trend line on Phase L3 (U) of 32% per month. **Recommendation:** carry out stator insulation repair with focus on the end windings.

HV Asset	Phase	OLPD Activity (nC/Cycle)	Standard Deviation (nC/Cycle)	OLPD Activity change rate (nC/Cycle)/(Month)	Avg PD Activity Increase Rate (%/Month)
Generator B	L1 (W)	5.72	4.12	-1.08	-18.89
	L2 (V)	49.06	19.70	-6.57	-13.38
	L3 (U)	4.58	4.20	-0.80	-17.43

L1 (Ch 09) Phase PD Activity (nC/cycle)

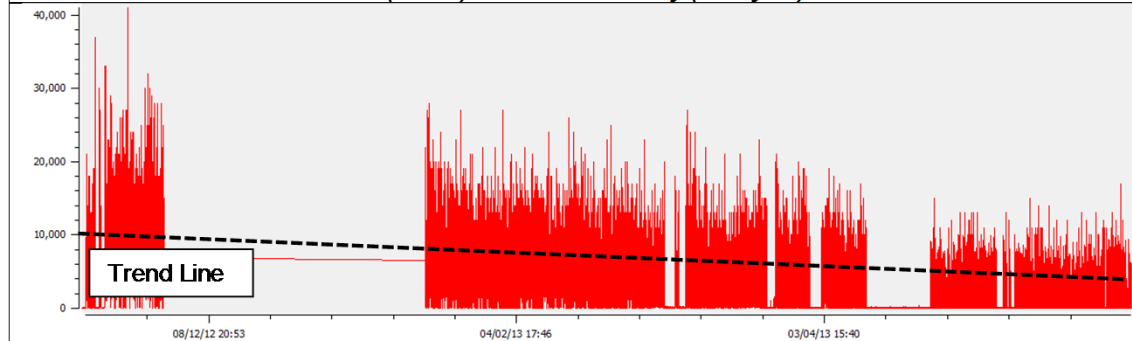

L2 (Ch 10) Phase PD Activity (nC/cycle)

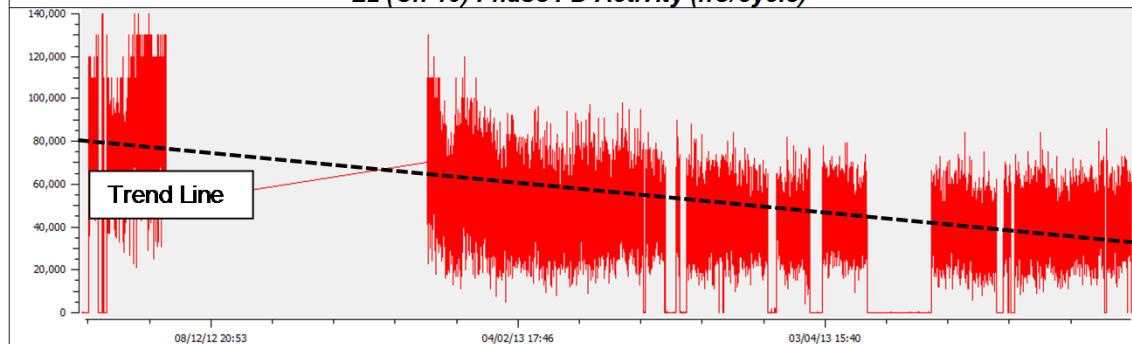

L3 (Ch 11) Phase PD Activity (nC/cycle)

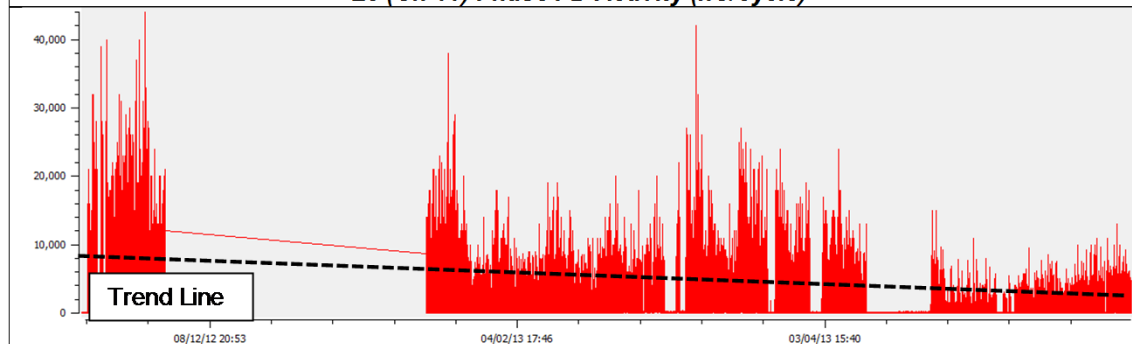

Note: Very low levels of OLPD Activity (<50nC) with a decreasing trend line seen on all phases.

Conclusion: the stator winding condition of the replacement Generator B is in the 'Excellent' condition category.

HV Asset	Phase	Average Activity (nC/Cycle)	Standard Deviation (nC/Cycle)	PD Activity change rate (nC/Cycle)/ (Month)	Avg. PD Activity Change Rate (%)/(Month) (%/Month)	HVPD Multi Monitor PD Trend	Condition
Generator B – Before Replace	U (Channel 11)	400	51.8	8.81	1.59	Increasing	Average
	V (Channel 10)	760	60.1	-0.24	-0.04	Stable	Probable Inspection
	W (Channel 09)	790	78.0	33.81	32.00	Increasing	Probable Inspection
Generator B – After Replace	U (Channel 11)	5	4.2	-0.80	-17.43	Decreasing	New/Excellent
	V (Channel 10)	49	19.7	-6.57	-13.38	Decreasing	New/Excellent
	W (Channel 09)	6	4.1	-1.08	-18.89	Decreasing	New/Excellent
Generator C – Before Replace	U (Channel 11)	964	117.3	16.12	1.67	Increasing	Probable Inspection
	V (Channel 10)	1244	157.8	27.41	2.21	Increasing	Problem / Unreliable
	W (Channel 09)	1418	188.7	37.14	2.62	Increasing	Problem / Unreliable
Generator C – After Replace	U (Channel 11)	TBC	TBC	TBC	TBC	TBC	TBC
	V (Channel 10)	TBC	TBC	TBC	TBC	TBC	TBC
	W (Channel 09)	TBC	TBC	TBC	TBC	TBC	TBC

- Note the PD Activity before (790nC/cycle) and after (49nC/cycle) **replacement of Generator B**.
- The replacement Generator B had a stator winding insulation condition in the **'New/Excellent'** condition category.

Generator B Average Peak

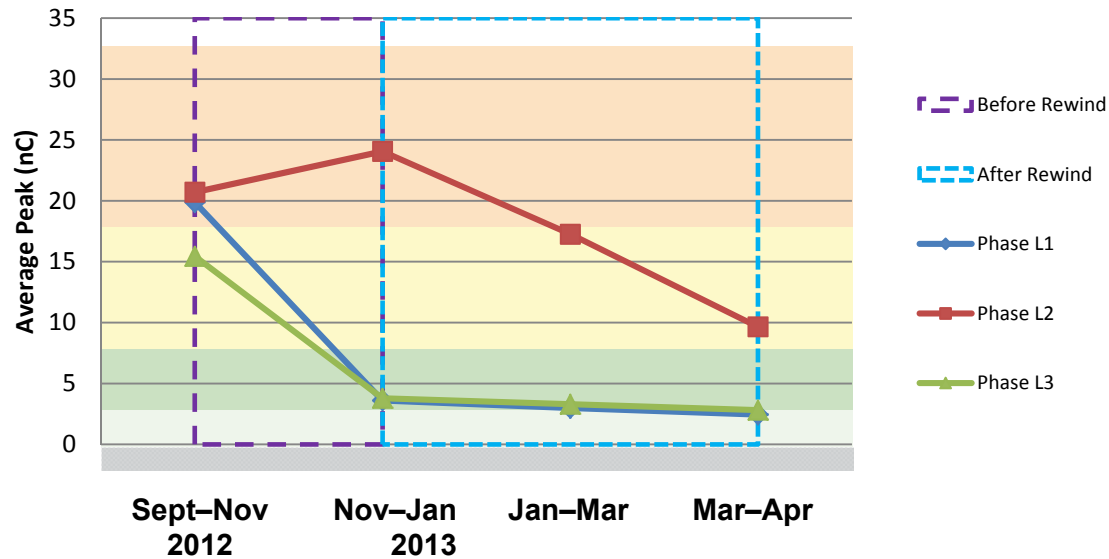

Generator B Activity

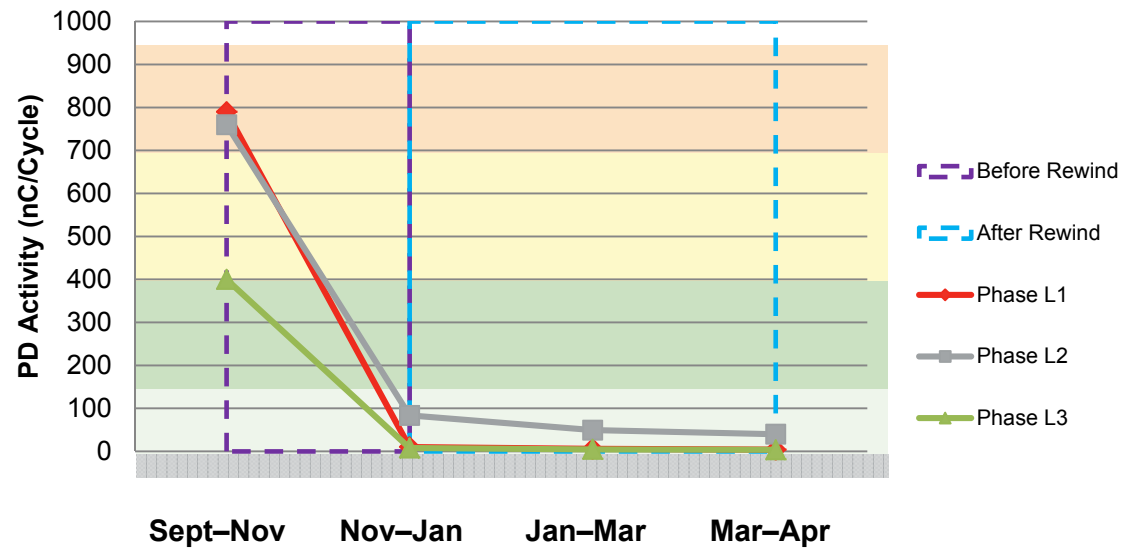

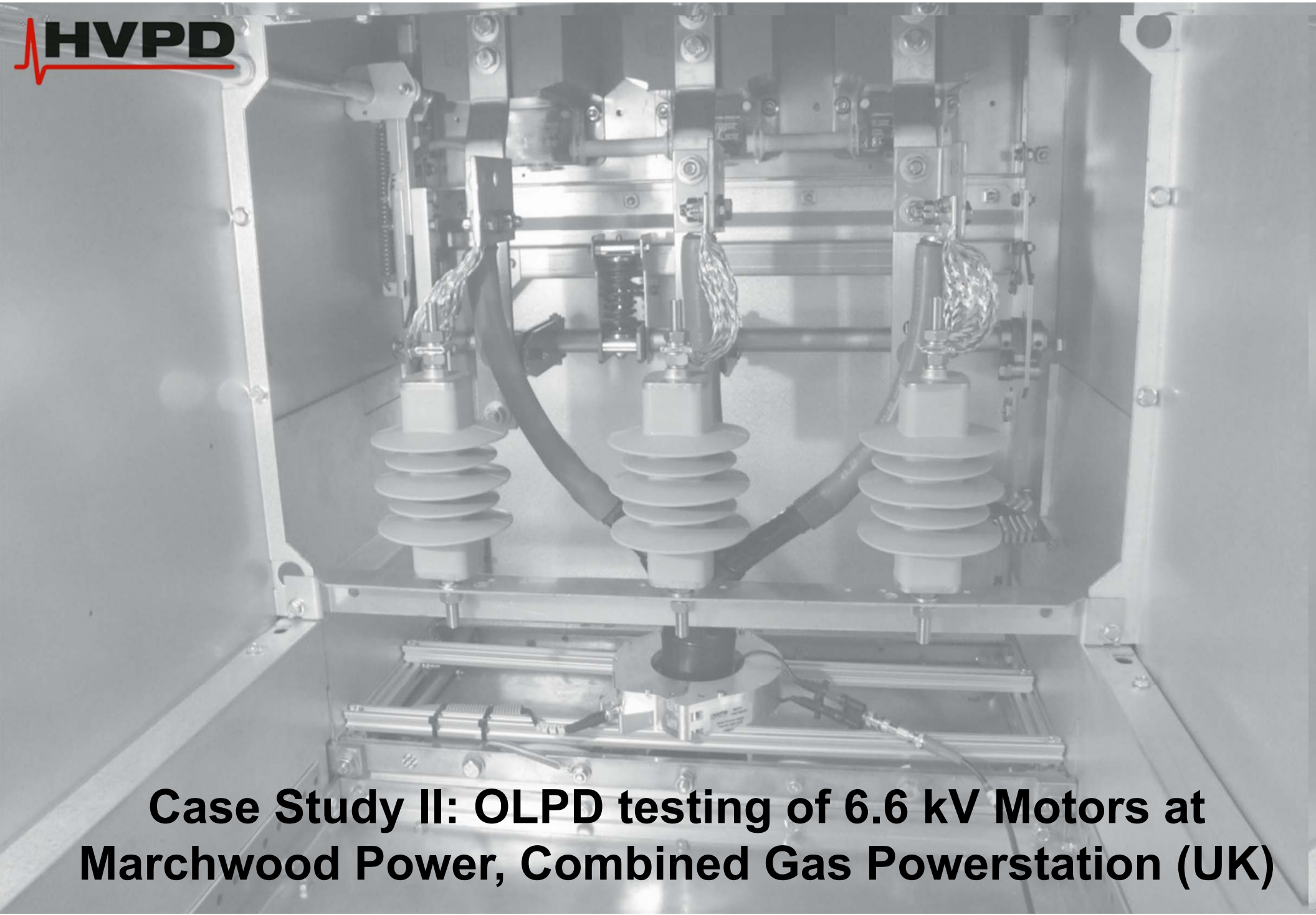

Case Study II: OLPD testing of 6.6 kV Motors at Marchwood Power, Combined Gas Powerstation (UK)

The HV motors were under a 3-year warranty and had been in-service for just over 2-years at the time of the test and monitoring project.

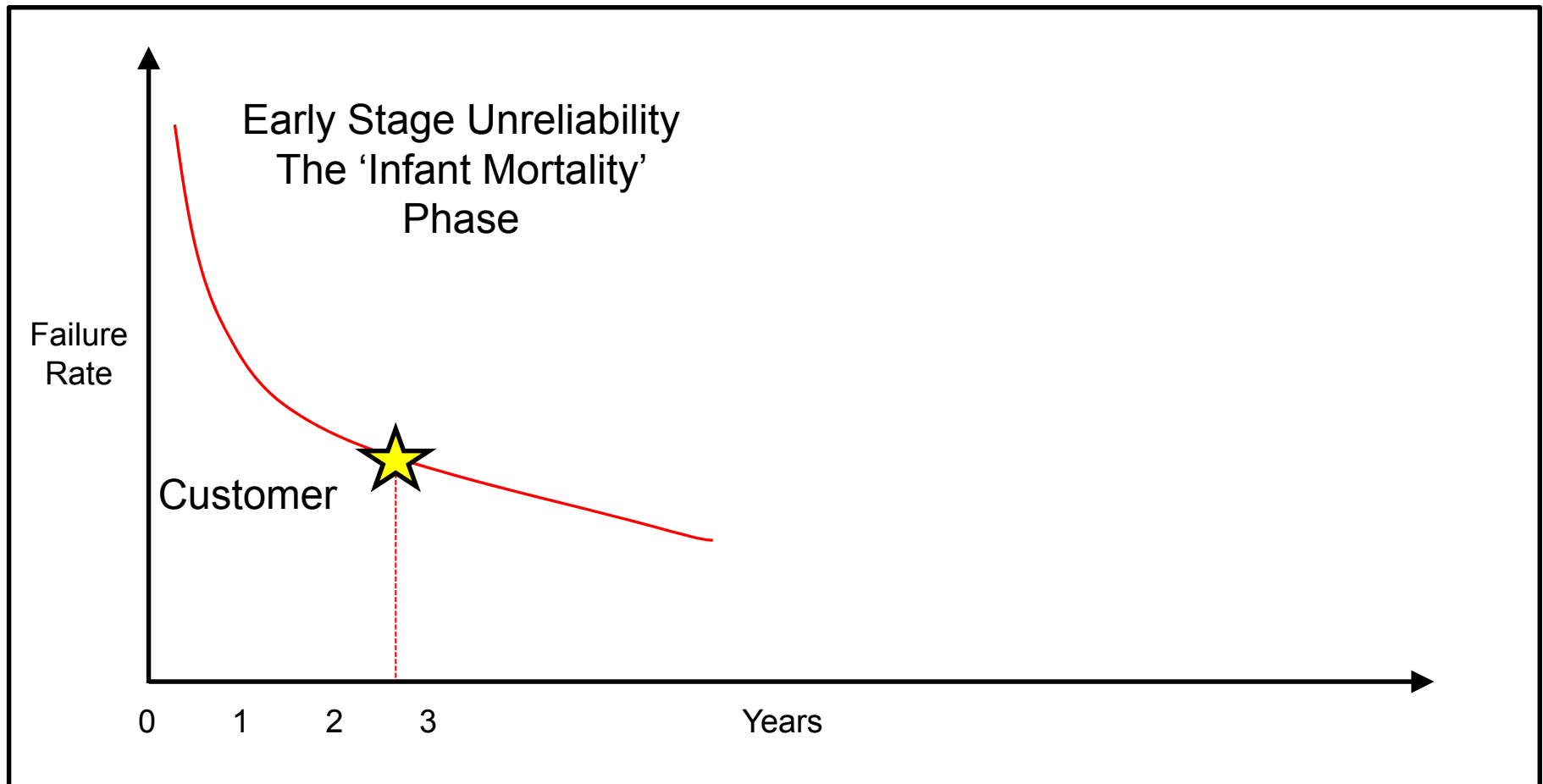

Motor	U Phase		V Phase		W Phase		All Phases	
	PD (IEC) Magnitude		PD (IEC) Magnitude		PD (IEC) Magnitude		PD (IEC) Magnitude	
	2010	2011	2010	2011	2010	2011	2010	2011
Motor B1	10,530	30,260	12,870	24,960	7,865	4,846	17,180	44,040
Motor B2	14,920	30,620	17,730	27,070	15,640	22,100	26,390	42,520
Motor B3	15,140	30,890	16,920	31,040	16,530	24,410	26,780	44,370

Off-line PD measurements (carried out by Siemens UK) for motors B1, B2 and B3 showed an increasing trend from the 2010 tests to the 2011 tests with an average increase in PD levels across all 3 motors of around 100%.

The PD levels **had doubled (in average) over the 12 months between these tests in 2010 and 2011.**

HFCT Sensors located at
HV Switchboard Cable End



Rotating HV Machine
End

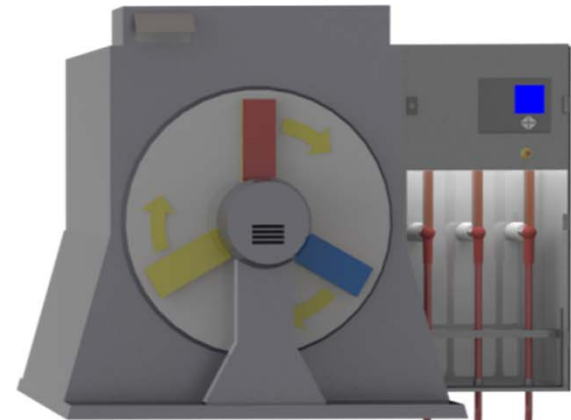

Range:
Up to 1 km for PVC
Up to 2 km for XLPE



Motor Ref	PD Level [pC]	PD Activity [nC/Cycle]
Manufacturer A – Motor 1	12,152	95
Manufacturer A – Motor 2	3,123	12
Manufacturer A – Motor 3	3,165	4
Manufacturer B – Motor 1	52,589	296
Manufacturer B – Motor 2	33,135	370
Manufacturer B – Motor 3	68,071	85

- Manufacturer A's feedwater pump HV motors (Ref: A1, A2 & A3) all had **Good to Average** PD levels with the stator insulation in the Green Condition Category - satisfactory condition.
- However, Manufacturer B's circulating water pump HV motors (Ref: B1, B2 & B3) all showed **Very High** PD activity levels (up to from 33,000 pC to 68,000 pC), **Red Condition Level – Problem/Unreliable**.

B1

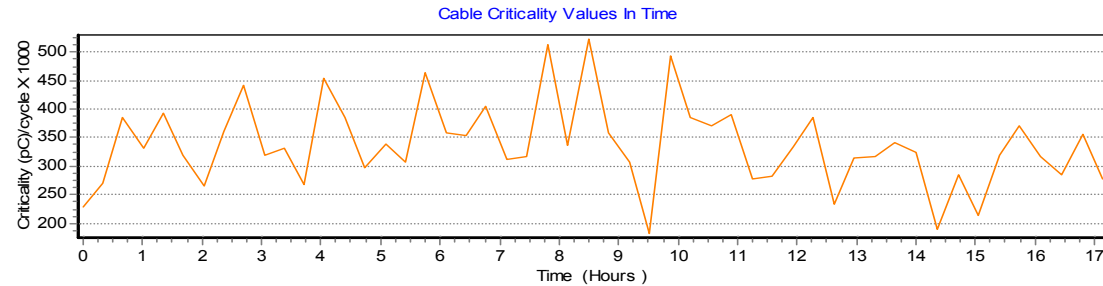

B2

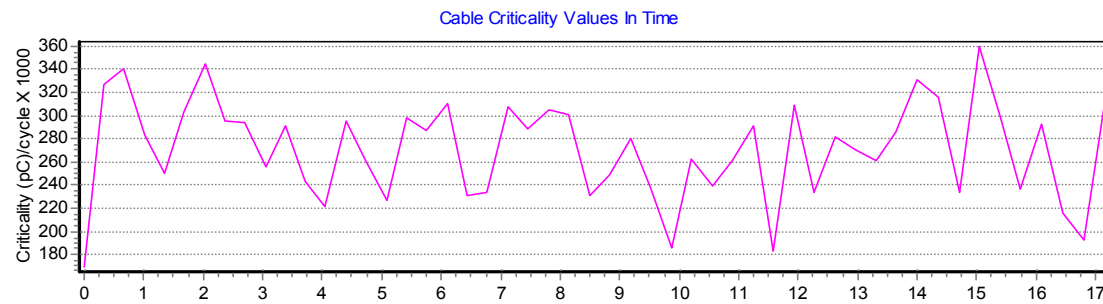

B3

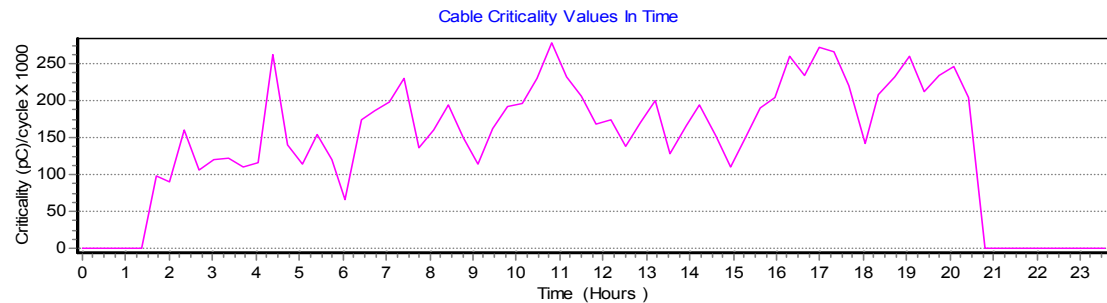

- A full visual internal investigation and OLPD monitoring of the B1, B2 & B3 motors was recommended to find the cause of the high PD on these 2-year old motors.
- All 'remote' HVPD results used a calculated **PPRF (PD Pulse Retention Factor)** which accounts for the signal attenuation along the 780m long XLPE feeder cables (PPRF for this cable = 0.79 i.e. 79% of the PD signal was retained after travelling along the cable from motor to switchgear).

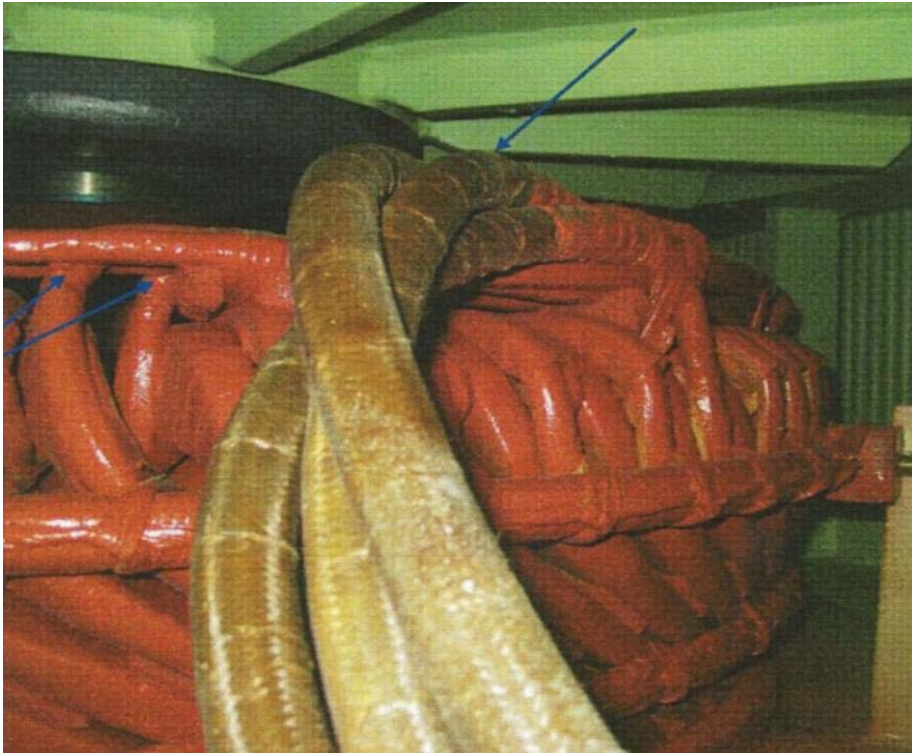
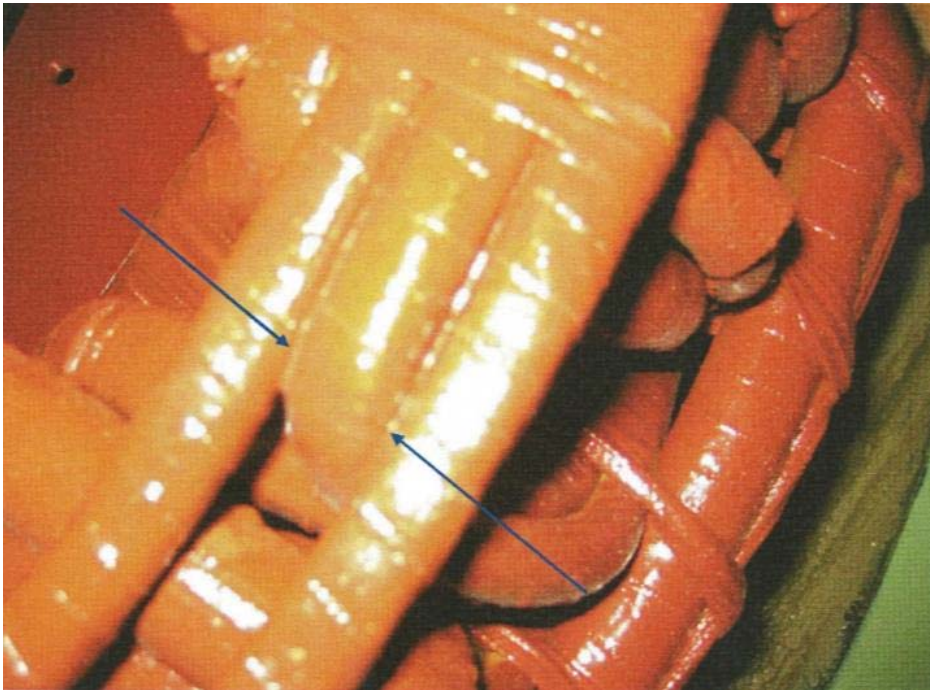

Image of Neutral Terminal Box. The Glass Cover (arrowed) was removed to inspect the windings



Image of winding connections. Neutral Cables and internal connections not spaced apart (arrowed)



**Image of connections not adequately spaced
(arrowed) = design issue**



**Image of coil – coil connections touching a neutral
cable (arrowed) = design issue**

Warranty
Claim with
6.6kV Motor
Manufacturer

Motor
Manufacturer
dismissed the
validity of
HVPD's
remote on-
line PD tests

Two
separate
third party,
off-line PD
tests backed
up HVPD's
findings.

**The motors
were
rewound
and repaired
under
warranty!**

Customer's feedback:

"Thanks for your support throughout the whole process, your equipment and advice has played a big role in a fairly complicated warranty claim that enabled us to successfully identify and rectify a manufacturing defect, which with PD was always going to be a difficult one to secure."



Example of Criticality 'OLPD League Table' for HV Motor Circuits from 12 Months of OLPD Monitoring Data (May 2012–May 2013)

Project Reference	Peak PD (nC)	Local PD (dB)	PD Activity (nC/Cycle)	Comments	PD Monitor	HVPD Multi™ Monitor PD Trend	Condition
001	140	<10	3899	Stator Slot & End-Winding Discharges	3 months	Stable	Problem / Unreliable
002	159	<10	3781	Stator Slot & End-Winding Discharges	12 months	Stable	Problem / Unreliable
003	57	<10	3543	Stator Slot & End-Winding Discharges	Not Installed	None – <i>monitor required asap</i>	Problem / Unreliable
004	44	<10	1427	End-Winding Discharges	<i>New Installation</i>	TBC - New	Problem / Unreliable
005	78	<10	1106	Stator Slot & End-Winding Discharges	3 months	Increasing	Problem / Unreliable
006	35	<10	1086	End-Winding Discharges	<i>New Installation</i>	TBC - New	Problem / Unreliable
007	55	<10	990	Stator Slot & End-Winding Discharges	7 months	TBC – Intermittent Use	Probable Inspection
008	13	<10	935	Stator Slot & End-Winding Discharges	<i>New Installation</i>	TBC - New	TBC – Requires monitor data
009	26	<10	847	End-Winding Discharges	<i>New Installation</i>	TBC- New	TBC – Requires monitor data
010	29	<10	570	Stator Slot & End-Winding Discharges	12 months	Decreasing	Still Acceptable
011	16	<10	262	Stator Slot Discharges	Not Installed	None – <i>monitor required</i>	TBC – <i>Requires monitor install</i>
012	21	<10	258	Stator Slot & End-Winding Discharges	3 months	Increasing	Still Acceptable
013	36	<10	102	Stator Slot & End-Winding Discharges	Not Installed	None – <i>monitor required</i>	TBC – <i>Requires monitor install</i>
014	No Data Available – HV Motor Not Energised				<i>New Installation</i>	TBC - New	TBC – Requires monitor data



Case Study III: OLPD testing of 10 kV motors and generators for BP/InSalah Gas, Krechba Facility, Algeria

- HVPD Engineers performed OLPD PD Testing on selection of ABB 10kV gas turbine generators and motors at BP/In Salah Gas, Krechba facility in Algeria in September 2010.
- Previous OLPD testing had been carried out 4 years earlier by HVPD (October 2006) after commissioning of the rotating machines ***when no PD activity was detected*** on any of the machines tested .





The OLPD testing in September 2010 was requested by BP after they suffered an ***in-service failure of the stator insulation on a 10 kV amine circulation pump***, causing operational disruption and loss of revenue.

2006

Site	Voltage (kV)	Plant	Circuit Reference	PD Level (pC)
Krechba	10	Gas Turbine "A"	A	No PD detected
Krechba	10	Gas Turbine "B"	B	No PD detected
Krechba	10	Amine Pump	C	No PD detected
Krechba	10	Amine Pump	D	No PD detected
Krechba	10	Amine Pump	E	No PD detected
Krechba	10	CO2 Compressor	F	No PD detected

2010

Site	Voltage (kV)	Plant	Circuit Reference	PD Level (pC)
Krechba	10	Gas Turbine "A"	A	13180
Krechba	10	Gas Turbine "B"	B	20450
Krechba	10	Amine Pump	C	11700
Krechba	10	Amine Pump	D	10600
Krechba	10	Amine Pump	E	12100
Krechba	10	CO ₂ Compressor	F	No PD detected

- The stator insulation failed at the location where the slot section meets the end winding
- This is a typical 'weak point' in the HV stator insulation system
- The failure was likely caused by condensation forming at this point, combined with a combination of high mechanical and electrical stresses at this location

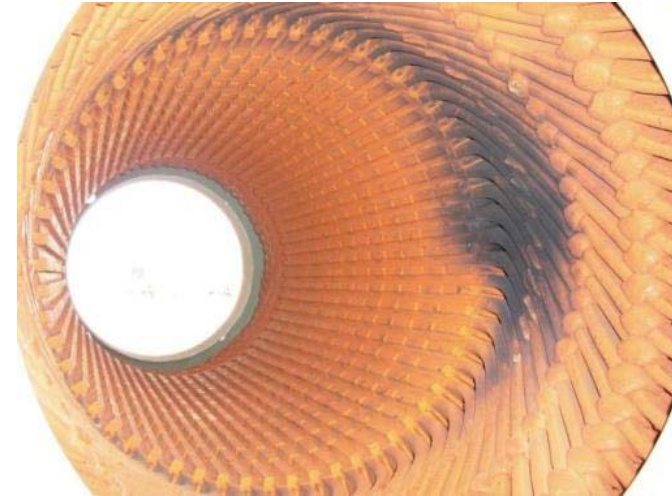

- The failed Amine Pump Motor had been previously tested 4 years prior to failure (in 2006) when ***no PD was detected.***
- The conclusion to this was: **4 years between tests is too long a time period!**
- HVPD's recommendations to the client included that in order to provide an effective 'early warning' system to avoid future in-service failures such as this that ***permanent OLPD sensors*** and a ***continuous OLPD monitoring system*** is installed to provide continuous 24/7 monitoring.



Case Study IV: OLPD testing and monitoring of a complete 11kV network on a Stena Drilling Vessel





- ‘Slot Section’ PD activity within generator easily measured at the switchboard end of the cable
- Conclusion: It is possible to monitor PD levels within generators on vessel with an HFCT sensor around each cable phase at the central switchboard

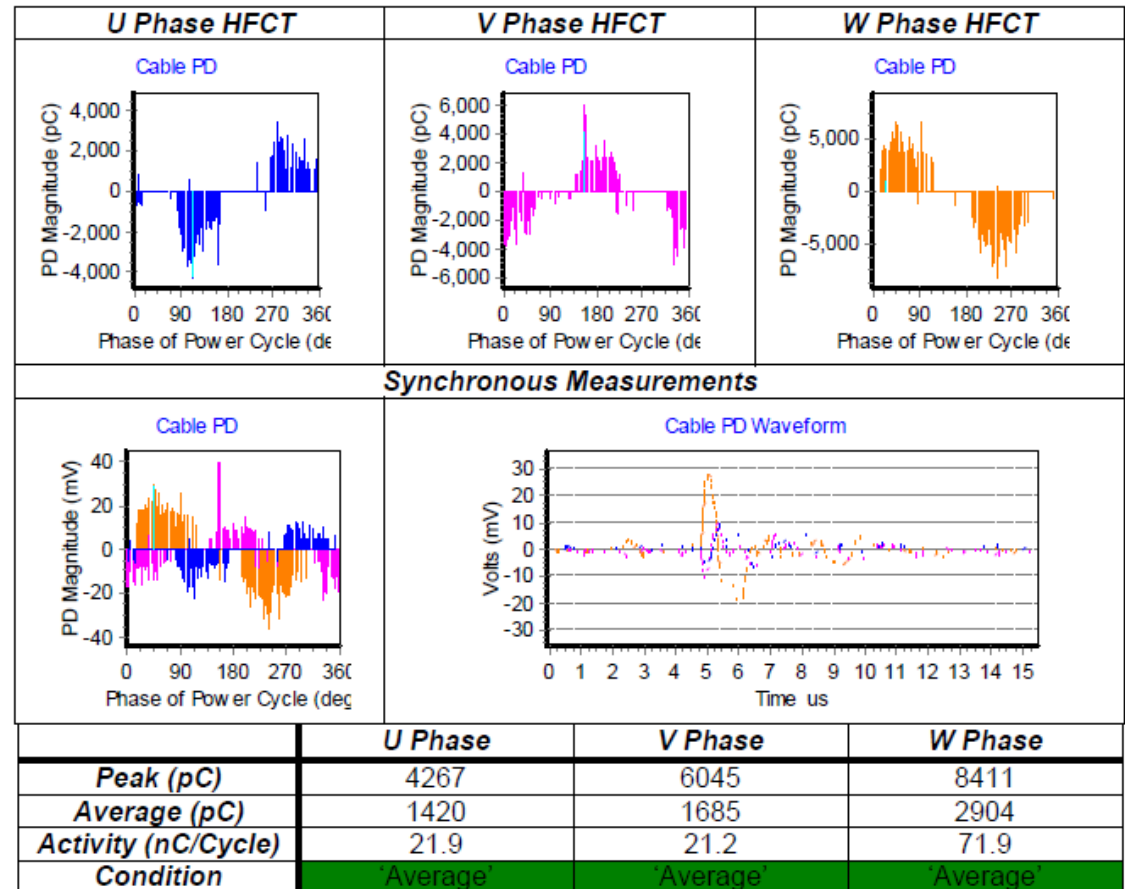

Port Switchboard (11kV)

Unit No	Description	No Cables	No HFCT's	Type	No TEV's	Total	Total Channels
1	Bus Tie (HV SWB 3)	4	1	140-100HC	1	2	
2	Thruster 1 HV Panel	2	1	140-100	1	2	
3	HV Transformer 1 FWD	1	1	140-100	1	2	
4	HV Transformer 1	1	1	140-100	1	2	
5	Topside HV Transformer 1 (HPU & LV)	2	1	140-100	1	2	
6	Generator 1	2	3	100-50HC	1	4	26
7	Generator 2	2	3	100-50HC	1	4	(2 Multi Units)
8	Busbar Measurement			N/A			
9	Topside HV Transformer 1 (VSD)	1	1	140-100	1	2	
10	Thruster 4 Transformer	2	1	140-100	1	2	
11	Emergency SWB (Incomer 1)	1	1	140-100	1	2	
12	Bus Tie (HV SWB 2)	4	1	140-100	1	2	

Central Switchboard (11kV)

Unit No	Description	No Cables	No HFCT's	Type	No TEV's	Total	Total Channels
1	Bus Tie (HV SWB 1)	4	1	140-100	1	2	
2	Thruster 3 HV Panel	2	1	140-100	1	2	
3	HV Transformer 2 FWD	1	1	140-100	1	2	
4	HV Transformer 2	1	1	140-100	1	2	
5	Topside HV Transformer 2 (HPU & LV)	2	1	140-100	1	2	
6	Generator 3	2	3	100-50	1	4	
7	Generator 4	2	3	100-50	1	4	28
8	Busbar Measurement			N/A			(2 Multi Units)
9	Topside HV Transformer 2 (VSD)	1	1	140-100	1	2	
10	Thruster 6 Transformer	2	1	140-100	1	2	
11	AFT Fire Pump	1	1	140-100	1	2	
12	Emergency SWB (Incomer 2)	1	1	140-100	1	2	
13	Bus Tie (HV SWB 3)	4	1	140-100	1	2	









Network Selection ▲

Network Options

View Level

Site Overviews

SLD Overlay

System Detail

Common Sites

Distribution Network

33 kV OWF Turbine Array

11 kV O&D Drilling Vessel

10 kV O&G Network

Sensor Configuration ▼

Monitor Configuration ▼

PD Measurements ▼

Presents data hierarchically using a 3-level interface:

- 1st level: all sites/vessels
- 2nd level: one site/vessel (entire SLD)
- 3rd level: one switchroom

Based on the network's single-line diagram (SLD)

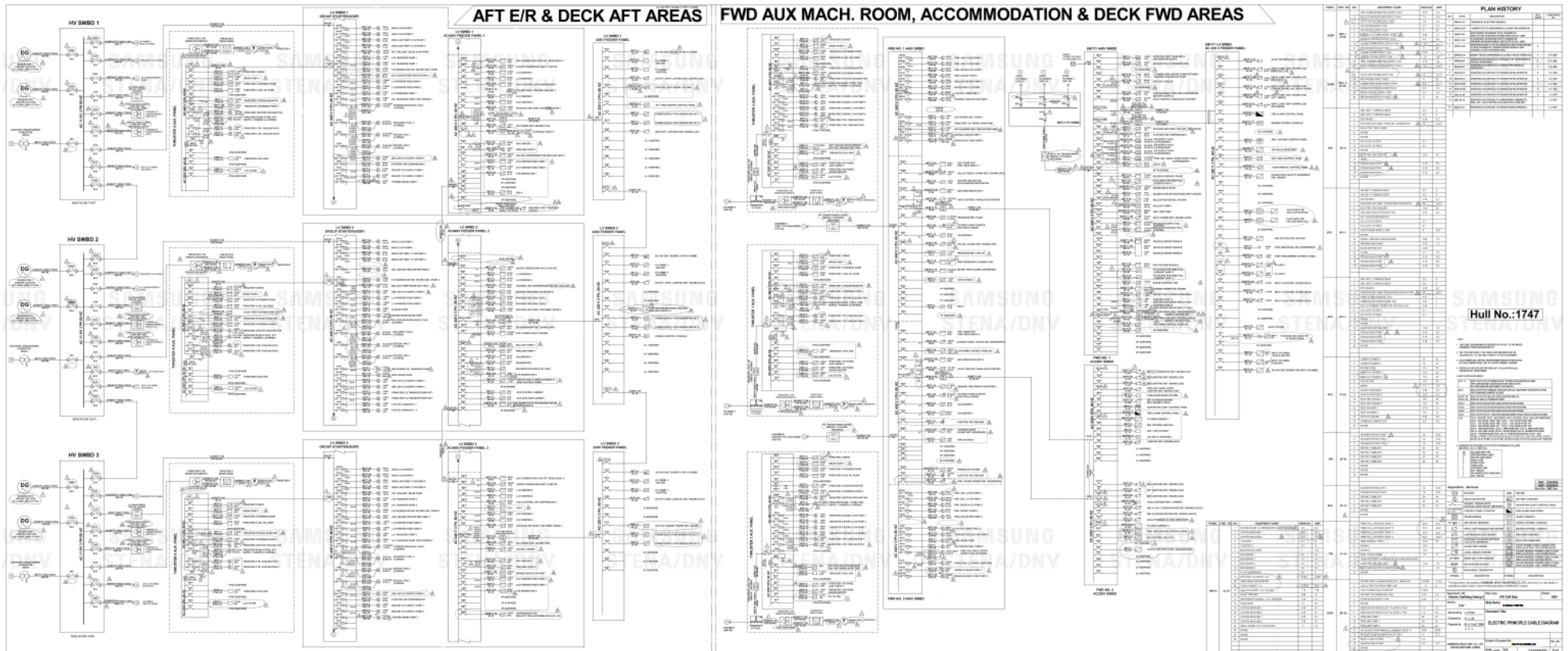

Analysis / Reports

Local Area Network Criticality League Table

Substations	Criticality (0-100)	
	Cable	Local
THRUSTER 1 HV PANEL	96	99
EARTHING Tx & RESISTOR	77	06
GENERATOR 1	13	74
HV Tx 1 (FWD)	16	70
HV SWBD 3 BUS TIE PANEL	13	65
TOPSIDE HV Tx 1 (HPU & LV)	09	39
GENERATOR 2	18	38
TOPSIDE HV Tx 1 (VFD)	36	44
HV SWBD 2 FEEDER	09	26
EM'CY HV SWBD INCOMER 1	25	21
THRUSTER 4 T/R	20	12

Condition / Action Guideline	Criticality (0-100)
High PD / Diagnostic	76-100
Moderate to High PD / Investigate	51-75
Moderate PD / Monitor	26-50
Plant OK / No Action	0-25

Key

- ID: Circuit ID
- Cable / Machine PD Activity
- Switchgear Local PD
- Cable length

Monitoring Period

12/04/15 14:00 - 13/04/15 14:00

Live Last Week
 Last 24 hrs Last Month

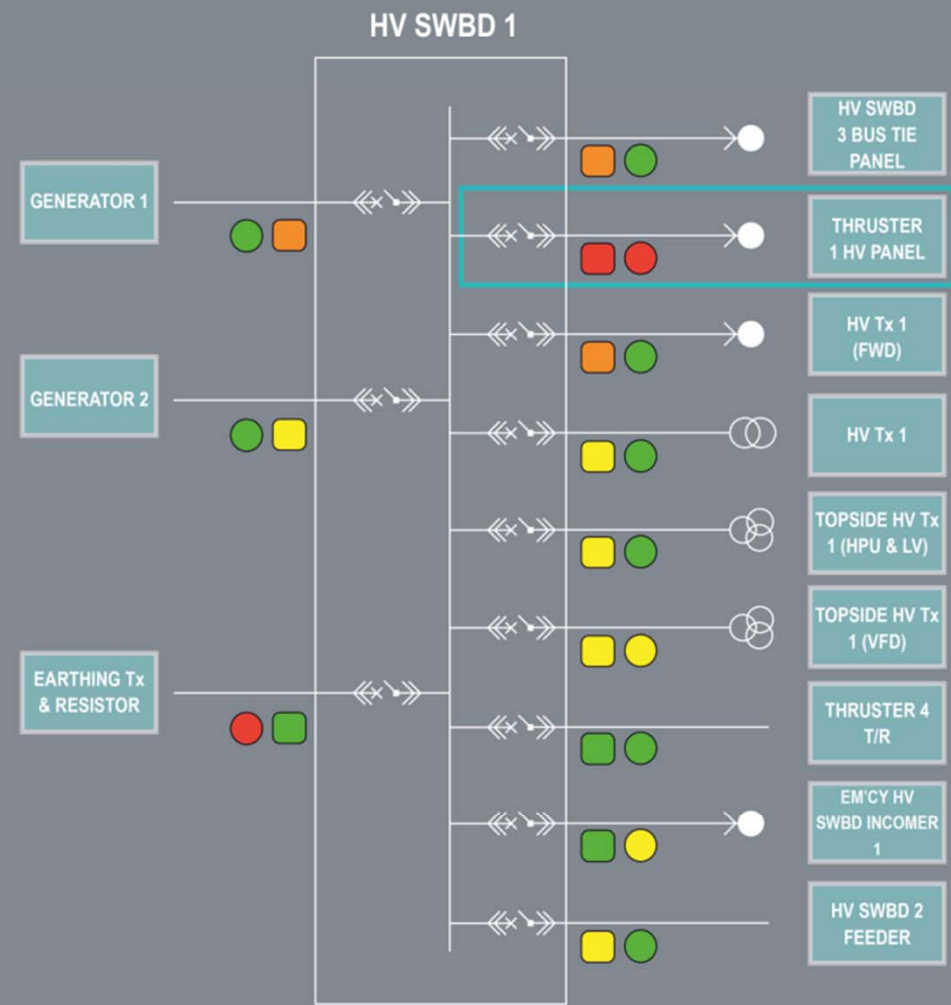

Network Selection

Network Options

- View Level
- Site Overviews
 - SLD Overlay
 - System Detail

Common Sites

- Distribution Network
- 33 kV O&W Turbine Array
- 11 kV O&D Drilling Vessel
- 10 kV O&G Network

Sensor Configuration

Monitor Configuration

PD Measurements

Analysis / Reports ▾

Local Area Network Criticality League Table		
Substations	Criticality (0-100)	
	Cable	Local
THRUSTER 3 HV Panel	96	99
EARTHING Tx & RESISTOR	77	06
HV SWBD 1 FEEDER	13	74
HV Tx 2 (FWD)	16	70
GENERATOR 3	13	65
GENERATOR 4	09	39
TOPSIDE HV Tx 2 (HPU & LV)	18	38
HV SWBD 3 FEEDER	36	44
HV Tx 2	09	32
TOPSIDE HV Tx 2 (VFD)	26	21
AFT FIRE PUMP	25	21
EM'CY HV SWBD INCOMER 2	20	12
THRUSTER 6 T/R	11	04

Condition / Action Guideline		Criticality (0-100)
High PD / Diagnostic		76-100
Moderate to High PD / Investigate		51-75
Moderate PD / Monitor		26-50
Plant OK / No Action		0-25

Key

- ID Circuit ID
- Cable / Machine PD Activity
- Switchgear Local PD
- M Cable length

Monitoring Period

12/04/15 14:00 - 13/04/15 14:00

Live Last Week
 Last 24 hrs Last Month

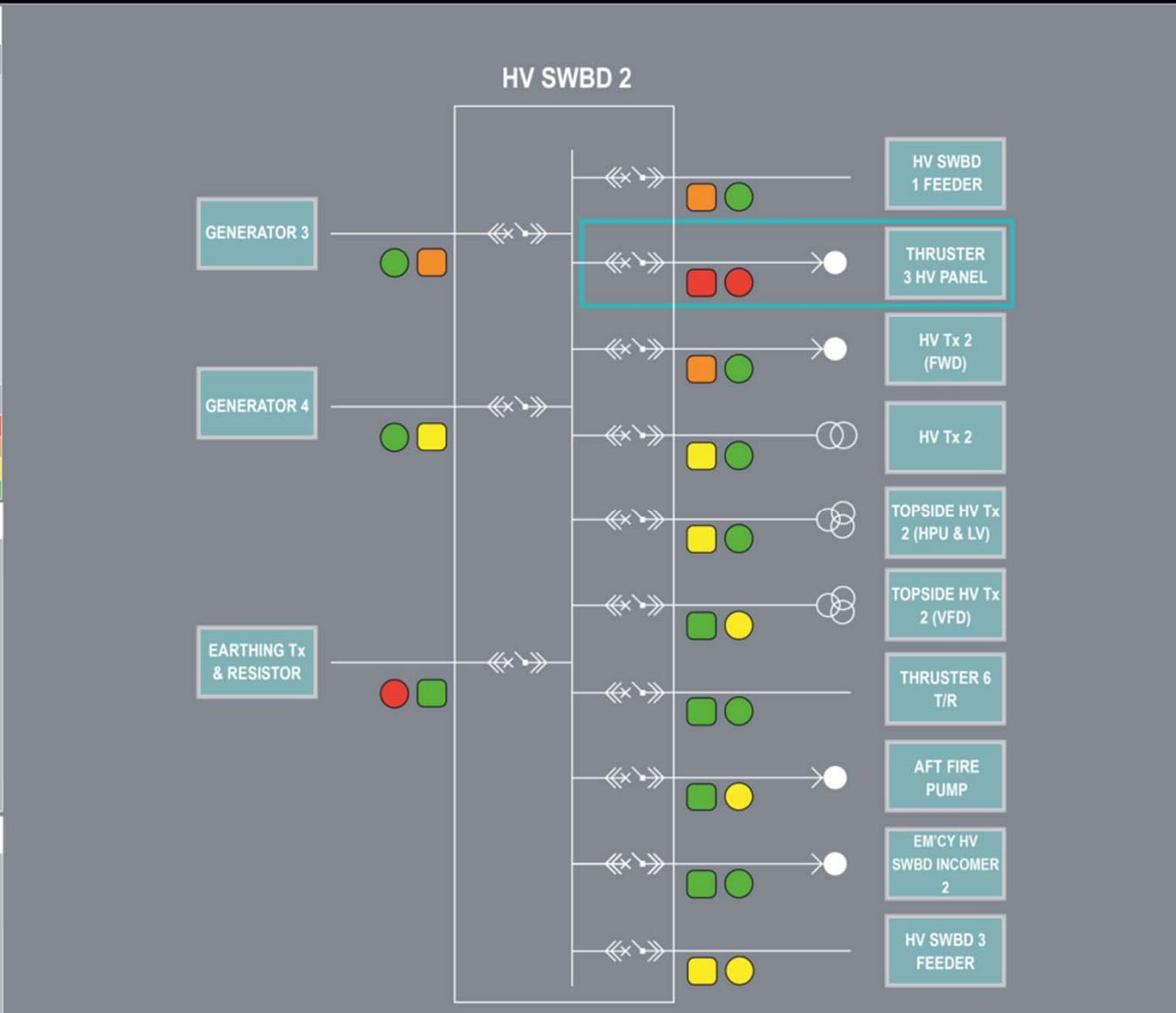

Network Selection ▲

Network Options

View Level

- Site Overviews
- SLD Overlay
- System Detail

Common Sites

- Distribution Network
- 33 kV OWF Turbine Array
- 11 kV O&D Drilling Vessel
- 10 kV O&G Network

Sensor Configuration ▾

Monitor Configuration ▾

PD Measurements ▾

Analysis / Reports

Local Area Network Criticality League Table

Substations	Criticality (0-100)	
	Cable	Local
THRUSTER 2 HV PANEL	96	99
EARTHING Tx & RESISTOR	77	06
HV Tx 3	13	74
HV SWBD 2 FEEDER	16	70
GENERATOR 5	13	65
TOPSIDE HV Tx 3 (HPU & LV)	09	39
GENERATOR 6	18	38
TOPSIDE HV Tx 3 (VFD)	36	44
THRUSTER 5 T/R	26	09
HV SWBD1 BUS TIE PANEL	25	21
EM'CY HV SWBD INCOMER 3	20	12

Condition / Action Guideline	Criticality (0-100)
High PD / Diagnostic	76-100
Moderate to High PD / Investigate	51-75
Moderate PD / Monitor	26-50
Plant OK / No Action	0-25

Key

- ID** Circuit ID
- Cable / Machine PD Activity
- Switchgear Local PD
- Cable length

Monitoring Period

12/04/15 14:00 - 13/04/15 14:00

Live Last Week
 Last 24 hrs Last Month

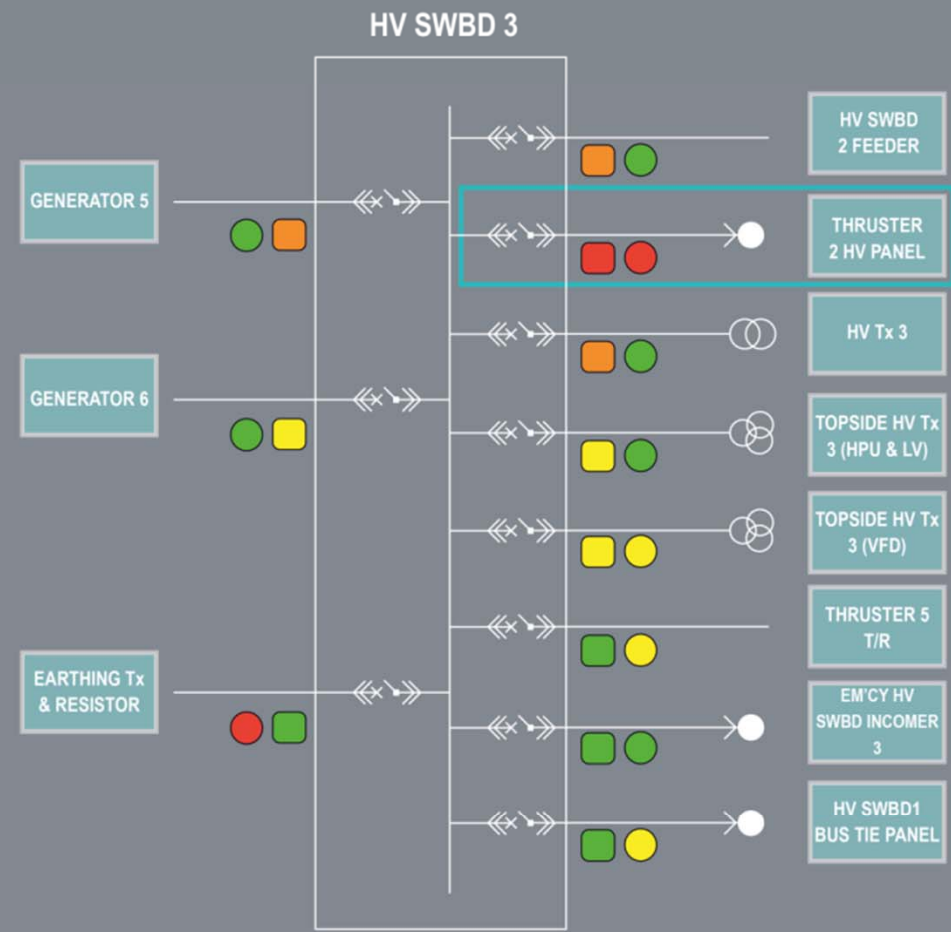

Network Selection

Network Options

View Level

- Site Overviews
- SLD Overlay
- System Detail

Common Sites

- Distribution Network
- 33 kV O&W Turbine Array
- 11 kV O&D Drilling Vessel
- 10 kV O&G Network

Sensor Configuration

Monitor Configuration

PD Measurements

Analysis / Reports ▾

Local Area Network Criticality League Table

Substations	Criticality (0-100)	
	Cable	Local
FROM HV SWBD 3 (3HP-10)	17	72
FROM HV SWBD 1 (1HP-11)	43	08
EM'CY HV Tx	27	18
FROM HV SWBD 2 (2HP-12)	03	16

Condition / Action Guideline	Criticality (0-100)
High PD / Diagnostic	76-100
Moderate to High PD / Investigate	51-75
Moderate PD / Monitor	26-50
Plant OK / No Action	0-25

Key

- ID Circuit ID
- Cable / Machine PD Activity
- Switchgear Local PD
- M Cable length

Monitoring Period

12/04/15 14:00 - 13/04/15 14:00

Live Last Week
 Last 24 hrs Last Month

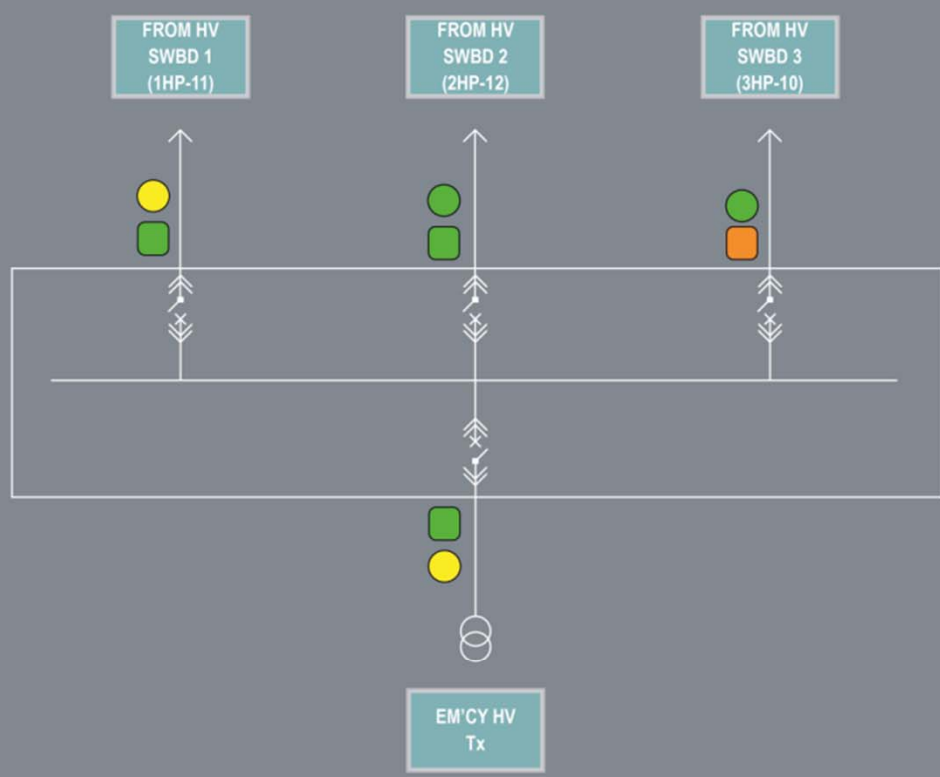

Network Selection ▾

Network Options

View Level

- Site Overviews
- SLD Overlay**
- System Detail

Common Sites

- Distribution Network
- 33 kV OWF Turbine Array
- 11 kV O&D Drilling Vessel**
- 10 kV O&G Network

Sensor Configuration ▾
 Monitor Configuration ▾
 PD Measurements ▾

Analysis / Reports ▾

Local Area Network Criticality League Table

Substations	Criticality (0-100)
FROM HV SWBD 3 (3HP-10)	17 72
FROM HV SWBD 1 (1HP-11)	43 08
EM'CY HV Tx	27 18
FROM HV SWBD 2 (2HP-12)	03 16

Condition / Action Guideline	Criticality (0-100)
High PD / Diagnostic	76-100
Moderate to High PD / Investigate	51-75
Moderate PD / Monitor	26-50
Plant OK / No Action	0-25

Key

- ID Circuit ID
- Cable / Machine PD Activity
- Switchgear Local PD
- Cable length

Monitoring Period

12/04/15 14:00 - 13/04/15 14:00

Live Last Week
 Last 24 hrs Last Month

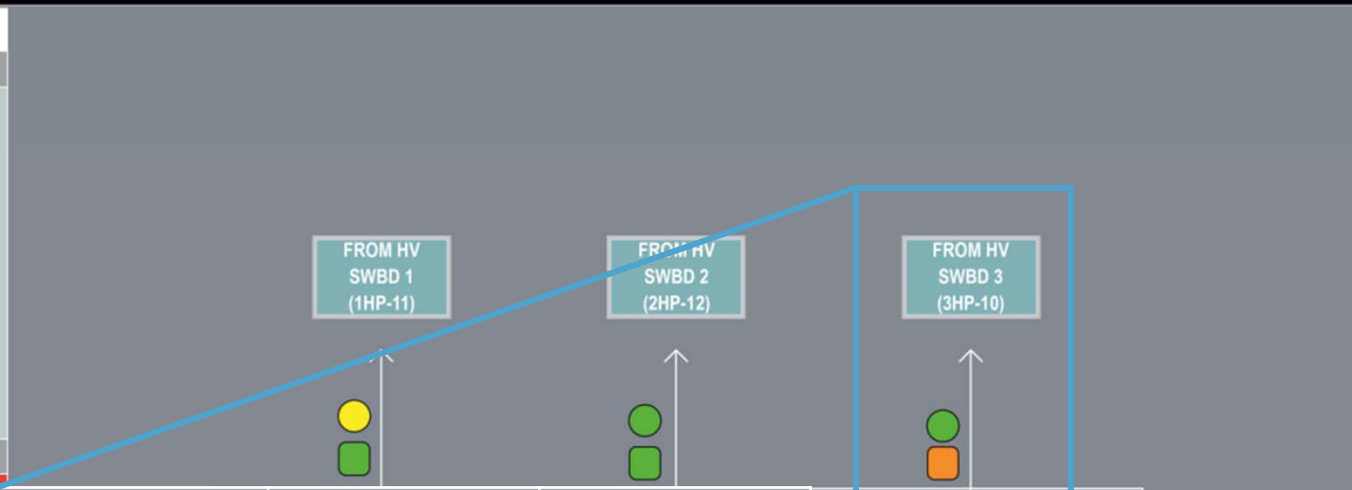

Sensor	Criticality	Trend
HFCT L1	17	
HFCT L2	11	
HFCT L3	9	
TEV	59	
AA Panel	72	
Type	AIS – Reyrolle Pacific	
Cable	XLPE	

Network Selection ▲

Network Options

View Level

- Site Overviews
- SLD Overlay
- System Detail

Common Sites

- Distribution Network
- 33 kV O&W Turbine Array
- 11 kV O&D Drilling Vessel
- 10 kV O&G Network

Sensor Configuration ▾
 Monitor Configuration ▾
 PD Measurements ▾

A grayscale photograph of an industrial facility, likely a refinery or oil processing plant. The image shows a complex network of pipes, walkways, and large storage tanks. In the background, two prominent tall smokestacks rise into the sky. The foreground includes a paved area with several vehicles, including cars and trucks, and a few workers walking. The overall scene is industrial and detailed.

**Case Study V: Ex/ATEX 10 kV Motor OLPD
test & monitoring project
(Tengizchevroil (TCO), Kazakhstan, 2011–2014)**

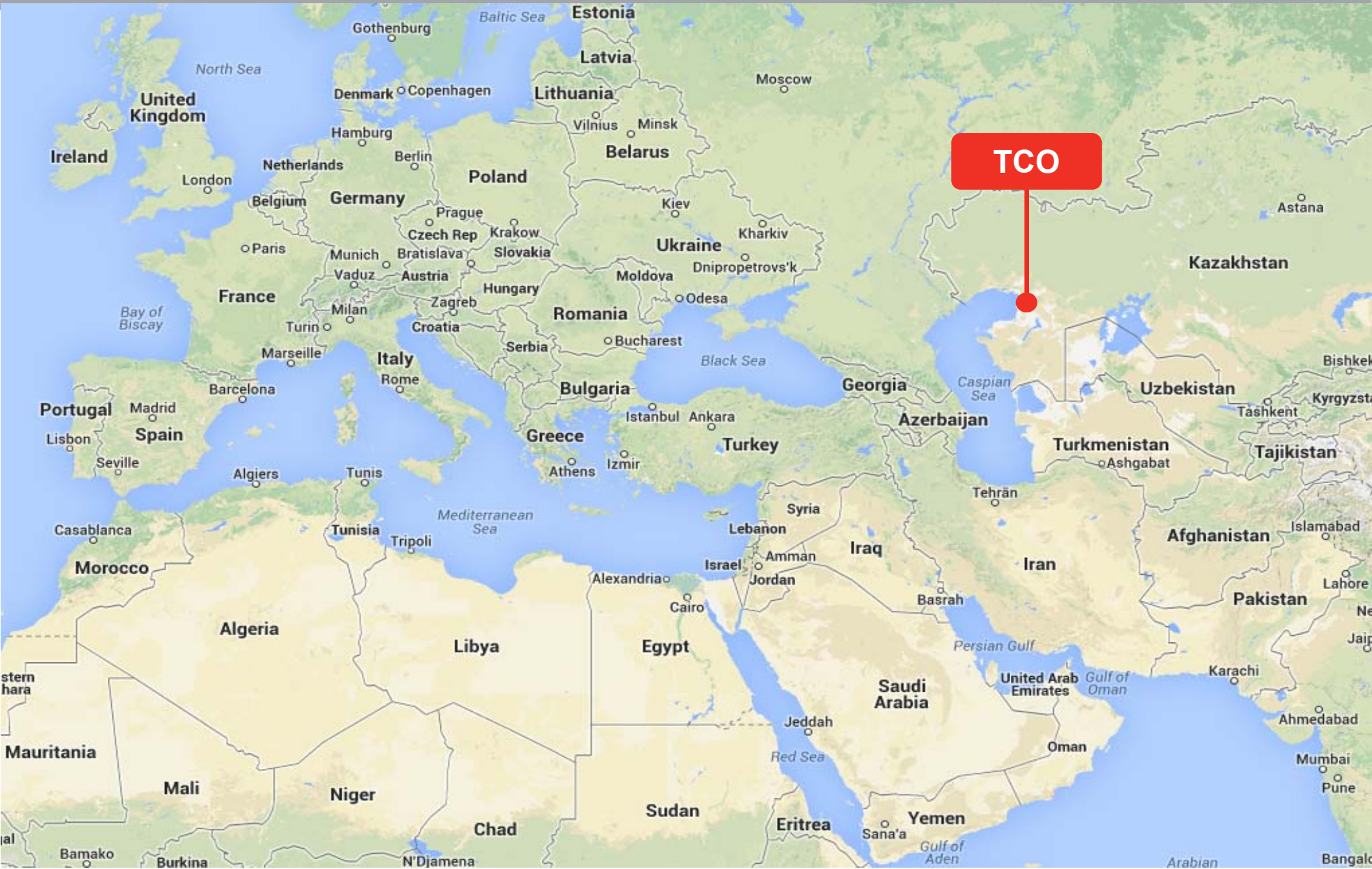

- Tengizchevroil LLP (TCO) was formed between the Republic of Kazakhstan and Chevron Corporation of the USA.
- The Tengiz field has a net daily production of 218,000 barrels of crude oil, 301 million cubic feet of natural gas and 18,000 barrels of LNG.
- 50% of the 100x in-service 10 kV Ex/ATEX motors at the facility had reached the 'design-life' of 20 years.
- TCO wanted to apply condition monitoring (CM) technology to provide **reliable life extension** of the assets.



100

Ex/ATEX HV motors in operation

50

These motors have now been in-service for 20 years

-40C – +40C

There is a wide range of ambient air temperatures at the site

- The 10kV HV motors at the facility are critical to production operations with only limited spares maintained at the site.
- Almost all of the HV motors at the facility are **Ex/ATEX rated**.
- A conventional partial discharge monitoring approach (using *High Voltage Coupling Capacitor* sensors) has been applied for the **10 kV gas turbine generators** at the facility (these are located in a non-Ex/ATEX location).
- The client required a solution for OLPD monitoring of their Ex/ATEX HV motors **without having to enter the Ex/ATEX hazardous gas zone**.





10 kV, 800 kW Amine Pump



10 kV, 2400 kW Air Blower

HVPD provide the following services for TCO:

- An ongoing installation of permanent HFCT sensors (located at the central HV switchboards) and HVPD Multi™ Monitors on HV motor circuits.
- Periodical and baseline *diagnostic* OLPD spot-testing using the HVPD Longshot™ OLPD test unit.
- Further integration of HVPD OLPD monitor technology interface to the TCO IT network through MODBUS and OPC protocols.

2011

September - Pilot Project – OLPD Test & Trial Monitoring

2012

January – TCO Purchase
31x HVPD Multi™
Permanent Monitors to
monitor 100x HV Motors

May – OLPD Test and
Monitor Installation started

August – OLPD Test,
Monitor Installation &
Monitoring Data Analysis

2013

May/June - OLPD Test, Monitor Installation, Monitoring Data Analysis and Further
Integration of HVPD Monitors into TCO IT Infrastructure

A large, light grey arrow pointing to the right, serving as a background for the central text.

**DATA HANDLING, HOSTING, ANALYSIS
AND SUPPORT**

A red rounded rectangle containing the year 2012 in white text.

2012

A red rounded rectangle containing the year 2017 in white text.

2017

- The monitoring technology applies knowledge held in **HVPD's OLPD Measurements Database**© that has a large population of measurement data on cables, switchgear, transformers, motors and generators.
- Identifies a HV network's '**worst 1%, 2% and 5%**' of assets and identifies any cables/plant/machines/transformers with a high risk of failure.
- All monitoring data is sent to the "**HVPD Decision Support Centre**" in Manchester, UK and HVPD's OLPD monitoring engineers provide data analysis and provide insulation condition status of the HV network.
- Condition Criticality Data is integrated in the facility's **Electrical Control System (ECS)** to raise 'flags' and/or alarms.
- The user interface screen includes the condition criticality data superimposed onto a 'mimic' of the network's **single-line diagram (SLD)**.



Example of Criticality 'OLPD League Table' for HV Motor Circuits from 12 Months of OLPD Monitoring Data (May 2012–May 2013)

Project Reference	Peak PD (nC)	Local PD (dB)	PD Activity (nC/Cycle)	Comments	PD Monitor	HVPD Multi™ Monitor PD Trend	Condition
001	140	<10	3899	Stator Slot & End-Winding Discharges	3 months	Stable	Problem / Unreliable
002	159	<10	3781	Stator Slot & End-Winding Discharges	12 months	Stable	Problem / Unreliable
003	57	<10	3543	Stator Slot & End-Winding Discharges	Not Installed	None – <i>monitor required asap</i>	Problem / Unreliable
004	44	<10	1427	End-Winding Discharges	<i>New Installation</i>	TBC - New	Problem / Unreliable
005	78	<10	1106	Stator Slot & End-Winding Discharges	3 months	Increasing	Problem / Unreliable
006	35	<10	1086	End-Winding Discharges	<i>New Installation</i>	TBC - New	Problem / Unreliable
007	55	<10	990	Stator Slot & End-Winding Discharges	7 months	TBC – Intermittent Use	Probable Inspection
008	13	<10	935	Stator Slot & End-Winding Discharges	<i>New Installation</i>	TBC - New	TBC – Requires monitor data
009	26	<10	847	End-Winding Discharges	<i>New Installation</i>	TBC- New	TBC – Requires monitor data
010	29	<10	570	Stator Slot & End-Winding Discharges	12 months	Decreasing	Still Acceptable
011	16	<10	262	Stator Slot Discharges	Not Installed	None – <i>monitor required</i>	TBC – <i>Requires monitor install</i>
012	21	<10	258	Stator Slot & End-Winding Discharges	3 months	Increasing	Still Acceptable
013	36	<10	102	Stator Slot & End-Winding Discharges	Not Installed	None – <i>monitor required</i>	TBC – <i>Requires monitor install</i>
014	No Data Available – HV Motor Not Energised				<i>New Installation</i>	TBC - New	TBC – Requires monitor data

- OLPD testing and monitoring of rotating HV machines, is a simple, non-invasive and effective way to assess the insulation condition of the machine's HV stator winding.
- There are a range of suitable OLPD sensors for this application with the best choice depending on the size and location of the rotating HV machine
- Such OLPD condition monitoring (CM) technology can be used to support Condition-Based Management (CBM) of rotating HV machines by identifying those machines in need to preventative maintenance to avoid unplanned outages.
- Increasing levels of PD activity provides an 'early warning' against insulation failure by detecting 'incipient' and developing HV insulation faults.
- Diagnostic condition assessment should be made using a combination of PD levels, PD activity and, most importantly, PD trend.
- All measurements are compared and benchmarked against HVPD's ***Rotating HV Machine Measurements Database***© to help assess the risk of HV stator winding insulation failure.

- HVPD have supplied condition-based assessment technology for the testing and monitoring of high voltage (HV) networks for over 20 years.
- We provide diagnostic and testing services, consultancy services, training and continuous ***On-line Partial Discharge (OLPD)*** monitoring systems.
- In 2011, HVPD developed a ***remote OLPD monitoring technique*** (in conjunction with Chevron, TCO and BP) for the monitoring of ***complete Ex/ATEX HV motor feeder cable circuits***, from the switchgear to the stator windings of the HV motor.
- This technique uses a combination of (3) wideband, ***high frequency current transformer (HFCT) sensors*** and (1) ***Transient Earth Voltage (TEV) sensor***, installed at the central HV switchboards.
- The technique is suitable for OLPD monitoring ***all types of rotating HV machines***, including motors and generators and can also be used to monitor the HV windings of remote transformers (although secondary monitoring systems are required to monitor 'beyond the transformer' such as VSD motors, as described in Presentation III).
- For the OLPD monitoring of large HV generators (>20MVA) HVPD use permanent ***high voltage coupling capacitor (HVCC)*** sensors located inside the generator cable box.