

Power Transformer Fundamentals: Design and Manufacturing

Waldemar Ziomek, Engineering Manager
CG Power Systems Canada Inc

IEEE Training, Houston, Texas,
Oct.8-9, 2013

Overview

- *Transformer Design*
 - *Transformer Types*
 - *Construction and Parts*
 - *Core & Coils*
 - *Electrical design*
 - *Losses & Impedance*
 - *Thermal, Dielectric & Short Circuit*
 - *Cooling & Sound Level*
 - *Mechanical design*
 - *Tank*
 - *Oil Preservation*
- *Transformer Manufacturing Process*

Power Transmission & Distribution

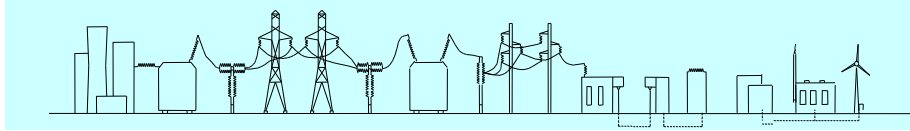

GENERATION TRANSMISSION SUB-TRANSMISSION DISTRIBUTION DISTRIBUTED POWER

115/10 or 20 kV		500/230		230/13.8
132		345/161		161
161		230/115		132
230		230/132		115
345				69
500				34

Generator Step-Up
Transformer

Auto-Transformer

Step-Down
Transformer

Pads

With and without LTC

3



Specification vs. Design



- *SPECIFICATION GIVES BASIC PARAMETERS:*
 - Voltages (kV, BIL) ,
 - power rating (MVA),
 - impedance (IZ), ...
- *DESIGNER/PRODUCER GIVES:*
 - Dielectric system
 - Magnetic system
 - Thermal system
 - Mechanical system
 - Oil flow 'system'
 - Sound 'system'

4



Standards



Smart solutions.
Strong relationships.

- **USA**

- (ANSI) IEEE Std C57.12.00-1993, standard general requirements for liquid-immersed distribution, power and regulation transformers ~ 50 Pages
- ANSI C57.12.10-1988, safety requirements 230 kV and below 833/958 through 8,333/10,417 KVA, single-phase, and 750/862 through 60,000/80,000/100,000 KVA, three-phase without load tap changing; and 3,750/4,687 through 60,000/80,000/100,000 KVA with load tap changing ~ 30+ Pages
- (ANSI) IEEE C57.12.90-1993, standard test code for liquid-immersed distribution, power and regulating transformers and guide for short-circuit testing of distribution and power transformers ~ 107 Pages
- NEMA standards publication no. TR1-1993; transformers, regulators and reactors ~ 2 Pages

- **CSA**

- **IEC**

5



AVANTHA
Group of Companies

Simple Transformer



Smart solutions.
Strong relationships.

- **Left coil - input (primary coil)**
 - AC Source is connected to
 - Magnetizing current flows and establishes the flux in core
- **Right coil - output (secondary coil)**
 - Load
- **Magnetic circuit (core)**
- **Problems ?** Stray flux, transients, heating, vibrations, noise, losses, regulation, saturation, human errors, dielectrics (high voltage insulation), non-linear magnetics, fluid dynamics, material defects, contamination, etc.etc.

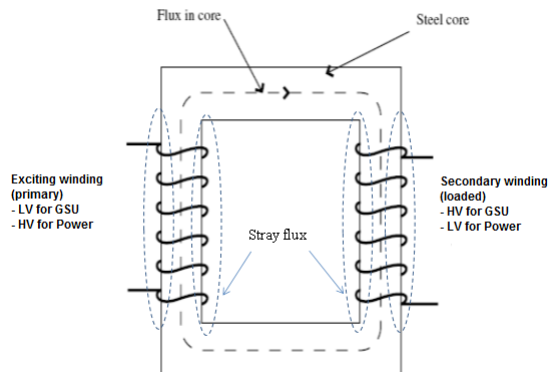

AVANTHA
Group of Companies

Real single phase transformer

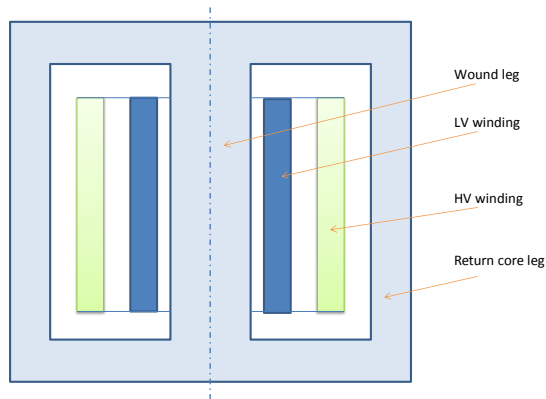

In order to better control the stray flux distribution, both windings are wound on same core leg



Equivalent Circuit

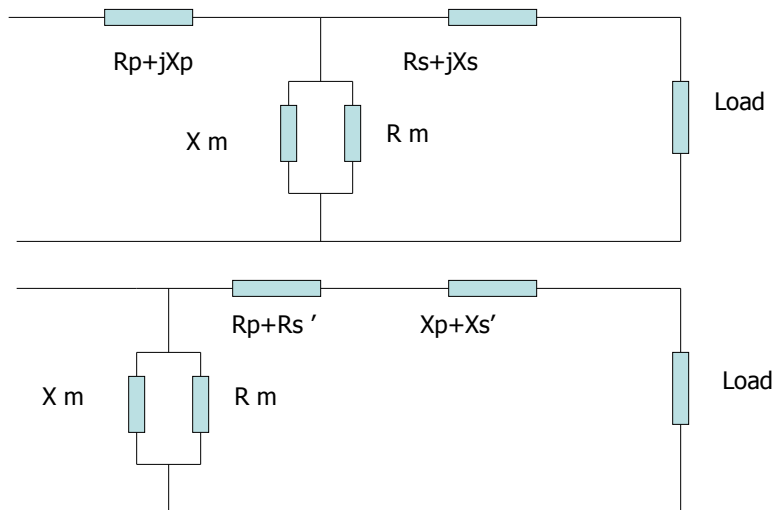

Transformer Design Basis

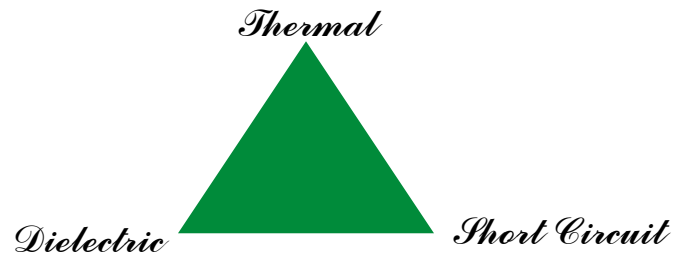

- ❖ Quality
- ❖ Reliability
- ❖ Consistent performance
- ❖ Long Service life

9



Design Procedure



- *Select Core Diameter & Area (A)*
- *Select Maximum Flux Density (Bm)*
- *Find Volts/Turn = $4.44 \times \text{Freq} \times Bm \times A$*
- *Find LV Turns = LV volts per Phase / (V/T)*
- *Find HV Turns = HV volts per Phase / (V/T)*
- *Select current densities LV & HV*
- *Select Conductor Area = Current / Density*
- *Select type of Winding:*
 - *Helical, Disc, Center-fed, end-fed*
- *Finalize HV Axial & Radial*
- *Finalize LV Axial & Radial*

10



Design Procedure



- *Select Core - LV; LV-HV Ducts*
- *Draw Ampere - Turn diagram*
- *Find Impedance % :* $u_x = x_k = 7.9 f \frac{(I_N T)^2}{S_N} k_R \frac{l_{avg}}{h} \left(\frac{a_1}{3} + \delta + \frac{a_2}{3} \right) 10^{-4} \%$

$$k_R = 1 - \frac{a_1 + a_2 + \delta}{\pi h}$$

a_1, a_2, δ - radial dimensions of two windings and the gap

$$l_{avg} = \pi D_{1-2} \quad \text{where } D_{1-2} = OD_1 + \delta$$

- *Check with guaranteed impedance, adjust V/T, height to get required impedance*
- *Finalize frame size- CD x WH x LC*
- *Find Iron Loss*
- *Find Load Loss*
- *Check for short circuit withstand*
- *Check for thermal withstand*
- *Check for impulse withstand*



Design Optimization

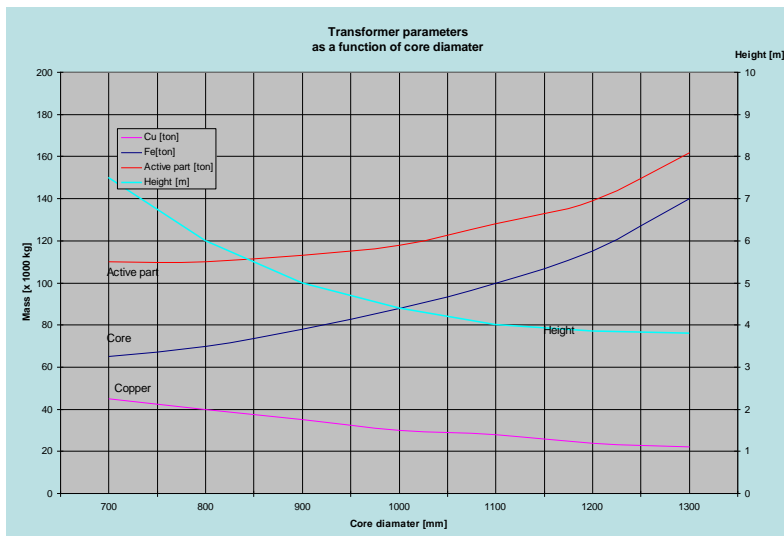

Design Optimization



Smart solutions.
Strong relationships.

- Windings which are closer to each other have lower impedance.
- The taller the winding – the lower the impedance.
- Impedance is changing in power two with the number of turns.
- Transformer impedance expressed in Ohms is independent from MVA base

13



AVANTHA
GROUP OF COMPANIES

Construction Type and Main Parts



Smart solutions.
Strong relationships.

- *Core- or Shell Form*
- *Windings – Circular for core-type , Pancake for shell-type*
- *Solid Insulation (turn-to-turn, section-to-section, winding-to winding, coil-to-core/clamp)*
- *Insulating liquid (coolant and main insulation)*
- *Tank*
- *Cooling equipment (radiators, coolers)*

14



AVANTHA
GROUP OF COMPANIES

Shell Form



Smart solutions.
Strong relationships.

1. high voltage bushing
2. tank top section
3. cooling equipment
4. oil circulating pump
5. tank bottom section
17. pancake coil
18. inter-phase block
19. L.V. coil group
20. H.V. coil group
24. tank shielding
25. insulating washer

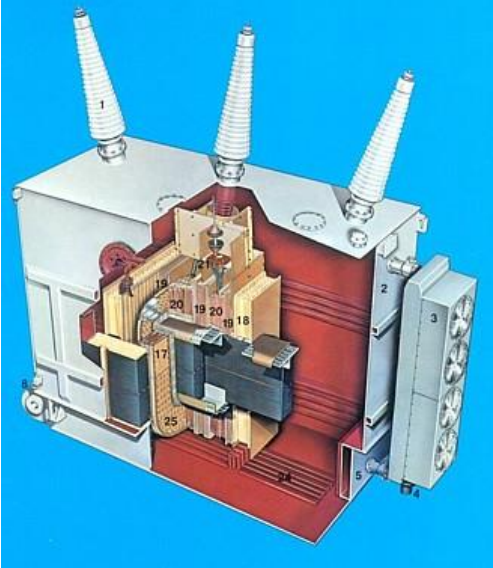

15



AVANTHA
GROUP COMPANY

Core Form



Smart solutions.
Strong relationships.

- *Concentric windings*
- *'Set' Winding Geometry*
- *Cooling options*
- *Cost consideration*
- *Shipping differences*

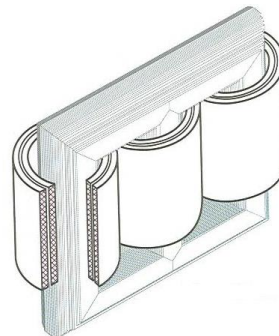

16



AVANTHA
GROUP COMPANY

Core Form

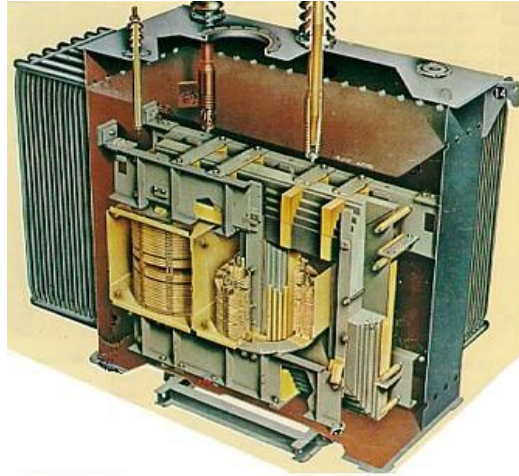

Types of Cores

Type 1

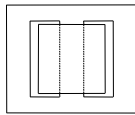

- 3 legs
 - 1 wound leg
 - 2 return legs
- legs and yokes not of equal cross section
- single-phase

Type 2

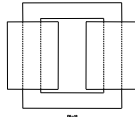

- 2 legs
 - 2 wound legs
- legs and yokes of equal cross section
- single-phase

Type 3

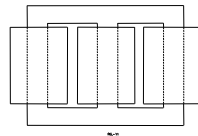

- 3 legs
 - 3 wound legs
- legs and yokes of equal cross section
- three-phase

Types of Cores cont.



Type 4

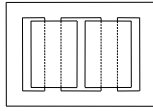

- 4 legs
 - 2 wound legs
 - 2 return legs
- legs and yokes not of equal cross section
- single-phase

Type 5

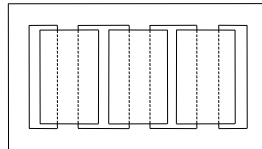

- 5 legs
 - 3 wound legs
 - 2 return legs
- legs and yokes not of equal cross section
- three-phase

19



Core Cutting



- “Core Form Design”
- Fully mitered & step lapped in corner joints
 - improves flux distribution, minimizes losses & sound level
- Circular core shape
 - provides windings with optimum radial support

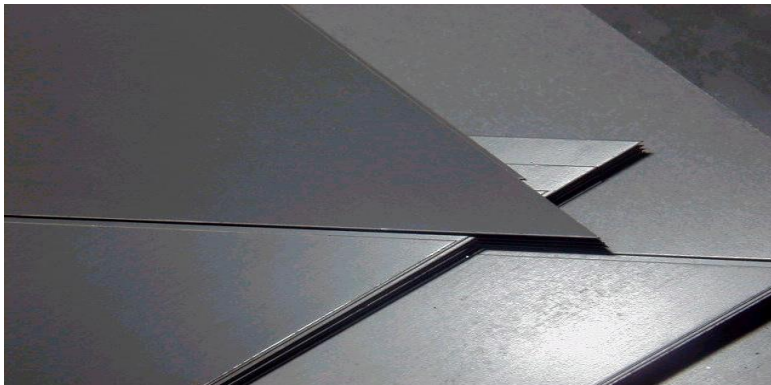

20



Core Stacking Methods

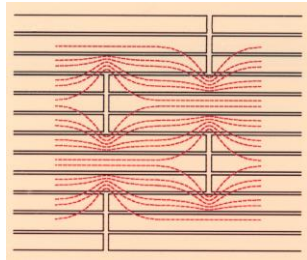

BUTT-LAP STACKING:

- Local concentration of flux
- higher excitation current & core loss

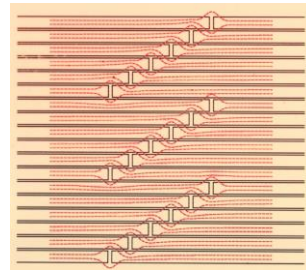

STEP-LAP STACKING:

- Reduced Local flux concentration
- lower excitation current & core loss

Core Material- Grain Oriented Silicon

M - NON-LS; H - LS H

ZDKH (laser scribed)

ZDMH (mechanically scribed)

21



Tie-rod Based Clamping Systems

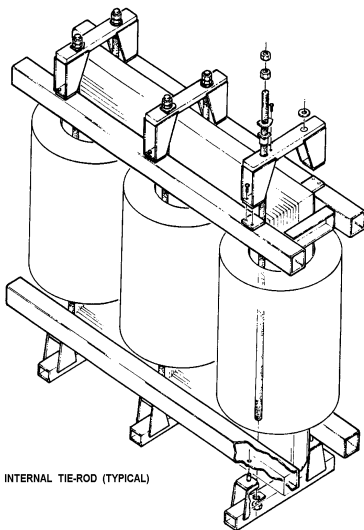

INTERNAL TIE-ROD (TYPICAL)

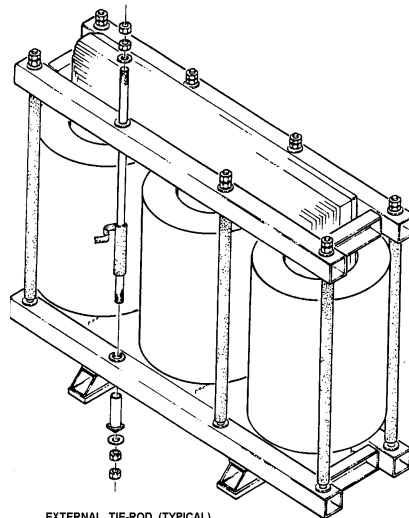

EXTERNAL TIE-ROD (TYPICAL)

22



Tie-plates and Clamping Beams

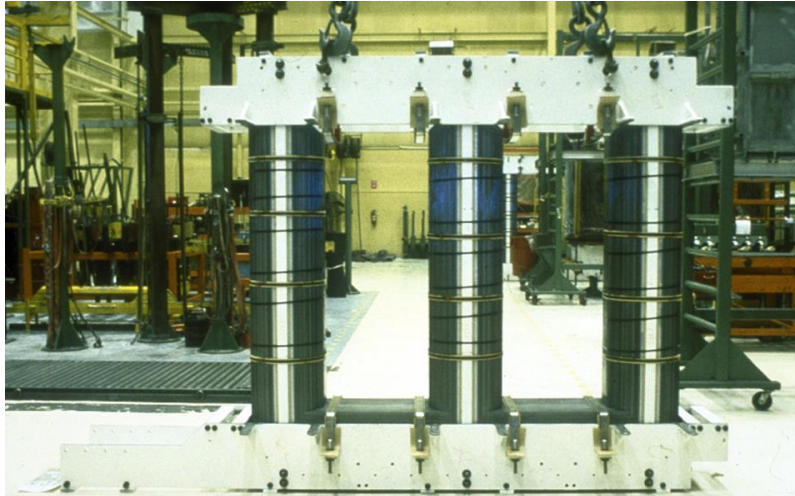

23



Winding Types – Layer / Barrel



- *Layer / Barrel*
 - *Mostly buried TV*
 - *Good space factor*
 - *Cooling only on vertical surfaces*

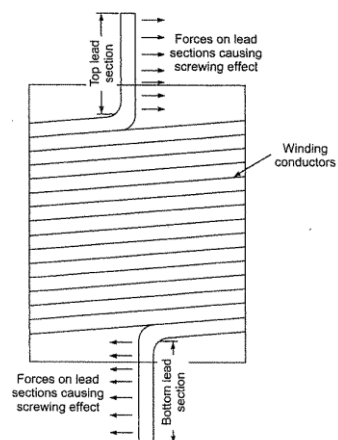

24



Winding Types - Helix



- *Helical Winding*
 - Inner windings
 - Axial ducts allow for cooling on horizontal surface

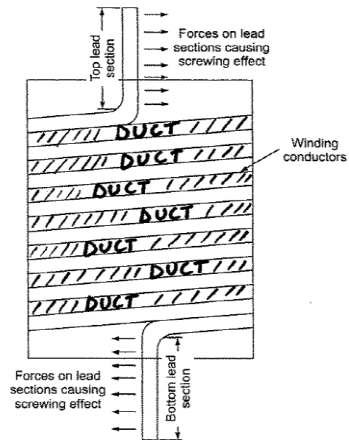

25



Winding Types - Helix

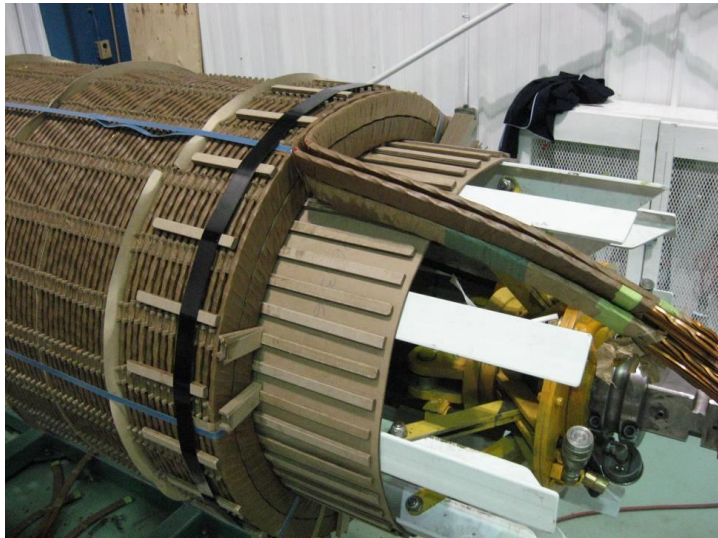

26



Winding Types - Multistart



- *Multistart Winding*
 - *Used mainly for LTC taps*
 - *Single or two layer*

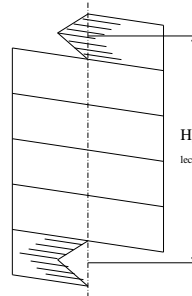

27



Winding Types - Multistart

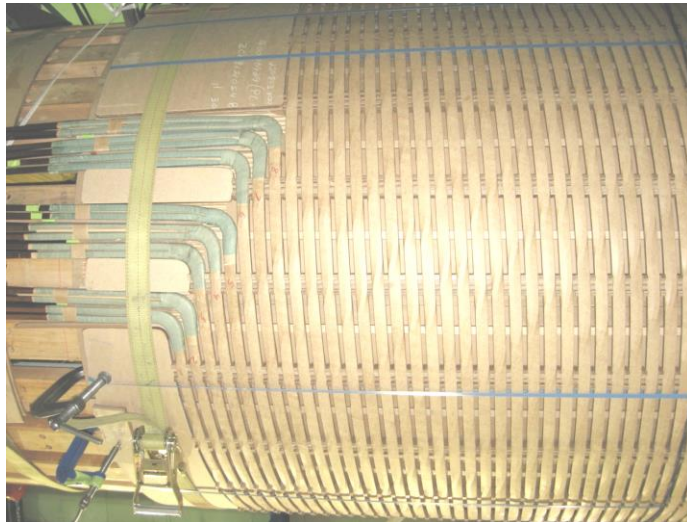

28



Winding Types – Tapped Disc / Helix



- *Tapped Disc / Helix*
 - Used mainly for outer LTC or DTC windings
 - Can be used internally, eccentric duct
 - Two symmetrical halves
 - Problems with impulse

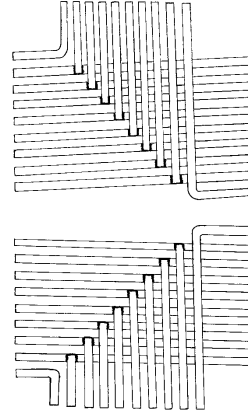

29



Winding Types – Tapped Disc / Helix



30



Winding Types – Disc Winding



- *Disc Winding*
 - Used for inner and outer windings

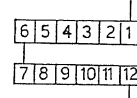
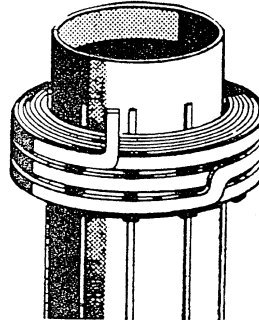

31



Winding Types – Disc Winding



32



Winding Types – Interleaved Disc



- *Interleaved Disc Winding*
 - *Improve impulse distribution*
 - *Various forms of interleaving*

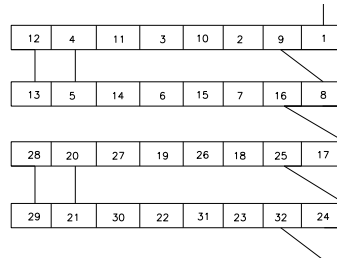

33



Winding Types – Shielded Disc



- *Shielded Disc Winding*
 - *Alternative to interleaving*
 - *No joins in the winding conductor*

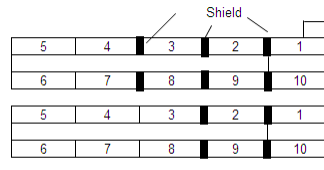

34



Winding Types – Shielded Disc



35



Magnet Wire, Paper Insulated

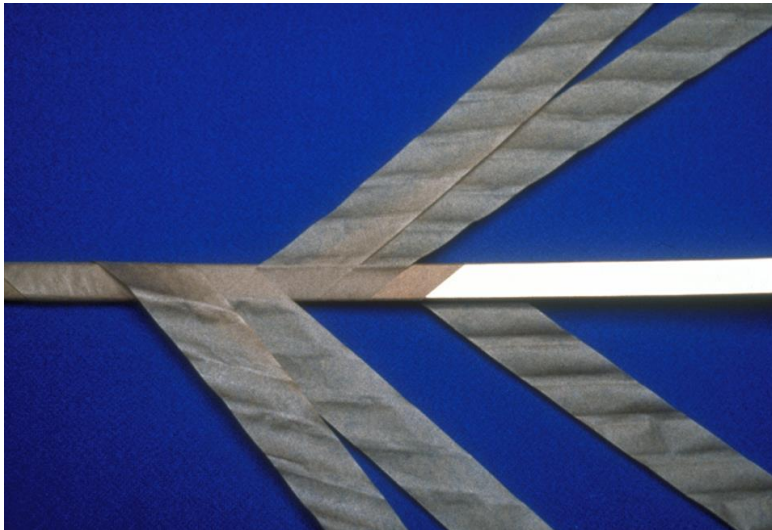

36



CTC - Epoxy Bonded, Netting Tape



Smart solutions.
Strong relationships.



37

AVANTHA
GROUP OF COMPANIES

Losses & Impedance



Smart solutions.
Strong relationships.

- **No – load losses:**
 - *Hysteresis and eddy losses in transformer core*
- **Load losses:**
 - **DC Losses**
 - *Resistive loss in winding conductor*
 - **Eddy Losses**
 - *Produced by stray flux in the windings when current is drawn from the transformer*
 - **Stray Losses**
 - *Eddy losses in constructional parts (clamps, tank wall, etc)*
- **Impedance**
 - *Dependent upon geometry, amp-turns, base power rating and frequency*
 - *Effect on short circuit currents/forces*

38

AVANTHA
GROUP OF COMPANIES

Eddy Losses in Conductor

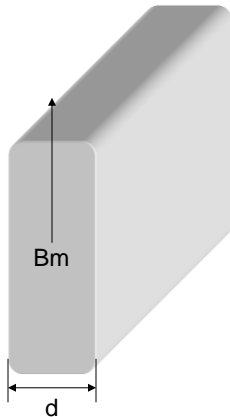

Eddy loss factor per unit of volume:

$$\frac{P_{eddy}}{V} = \frac{\omega \phi \alpha}{2\mu} \left(\frac{B_m}{\sqrt{2}} \right)^2 \frac{W}{m^3}$$

where

$$\omega = 2\pi f; \Delta = \sqrt{\frac{2}{\omega \mu \gamma}}; \phi = \frac{d}{\Delta}; \mu = 4\pi 10^{-7} \frac{H}{m}; \gamma = 20.967 \cdot 10^{-9} \frac{\Omega}{m}$$

$$\alpha = \frac{sh\phi - \sin\phi}{ch\phi - \cos\phi};$$

for $d \ll \Delta$ $\alpha \approx \frac{d}{3\Delta}$, then

$$\frac{P_{eddy}}{V} = \frac{\pi^2}{6} f^2 \gamma d^2 B_m^2$$

39



Sound Level



- *Magnetostriction - varying magnetic flux produces vibrations at fundamental frequency of 120 Hz for 60Hz power frequency (or 100 Hz at 50Hz power)*
- *Sound level depends on:*
 - *core material*
 - *flux density in core*
- *- core weight - sound level increases proportionally to log (weight),*
 - *tank design and cooling system (# and type of fans, pumps)*
- *Measured at 0.3 m for core alone and at 2 m for top rating (with whole cooling equipment on)*
- *Sound level under load becoming a new requirement*

40



Stray Flux Distribution

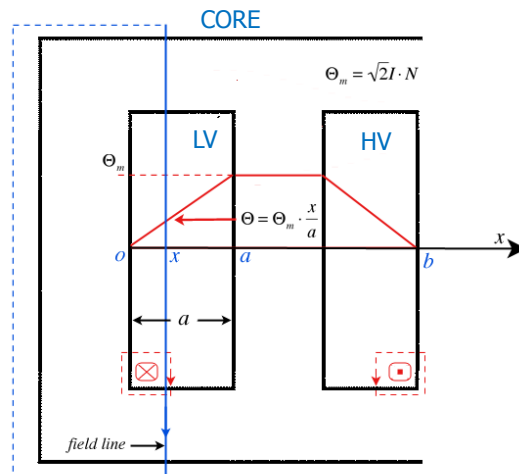

Stray Flux Distribution

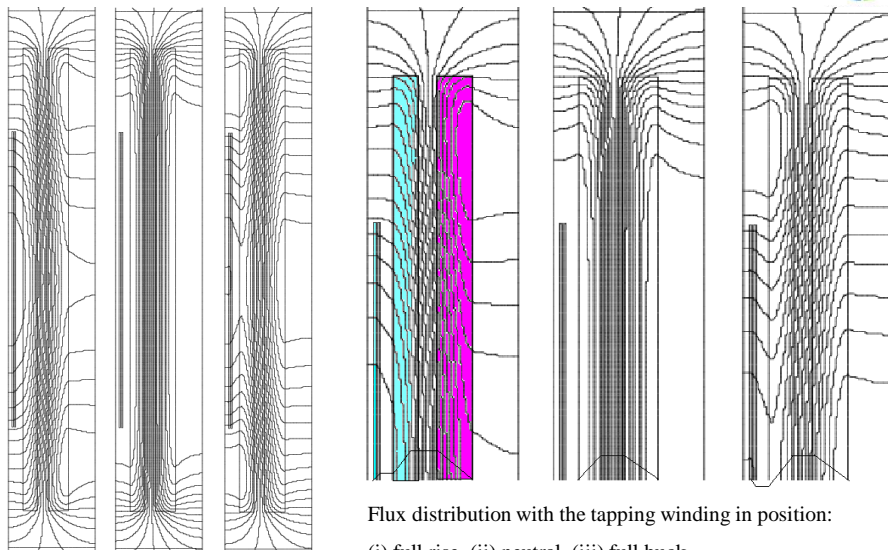

Flux distribution with the tapping winding in position:

- (i) full rise, (ii) neutral, (iii) full buck

Stray flux distribution – controlling the eddy loss by varying conductor size

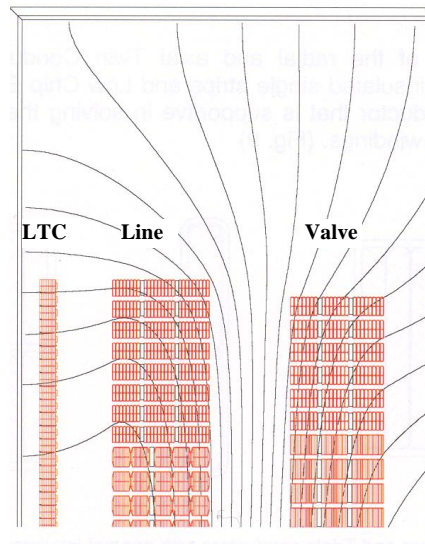

43



Mechanical Forces in Windings

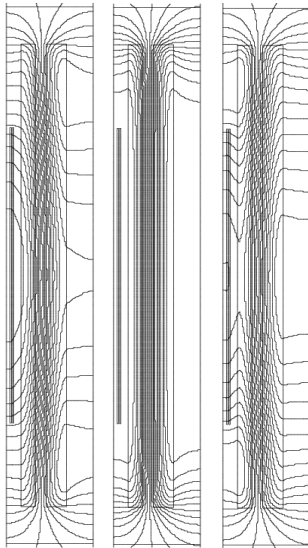

- *Stress due to radial forces:*
 - *Hoop on outer winding*
 - *Buckling on inner winding*
 - *Radial bending*
- *Stress due to axial forces:*
 - *Compressive on keyspacer*
 - *Tilting of conductors*
 - *Axial bending between keyspacers*
- *Spiralling forces*

44



Losses in Tank Wall

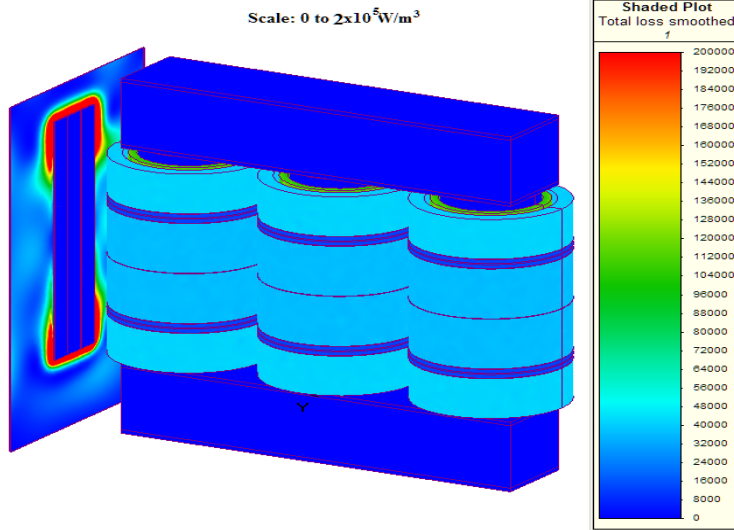

Losses in Constructional Parts

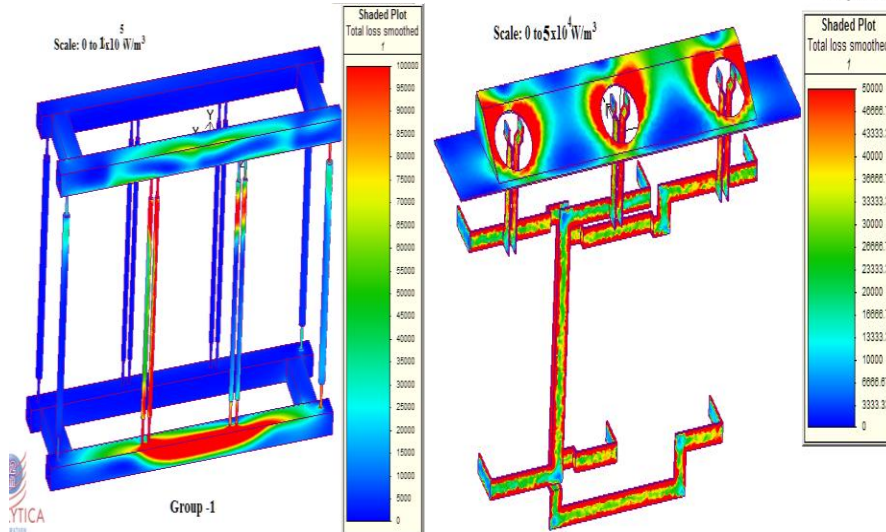

Insulation Coordination & Design Impact



<i>Withstand voltage</i>	<i>Impact on design</i>
BIL (LI)	Bushings, lead structure & its clearances, winding clearances, stresses to ground, neutral point insulation
SIL	External clearances, lead clearances, phase-to-phase stresses
Induced voltage	Internal winding stresses (V/T), stresses to ground, phase-to-phase stress
Applied voltage	Stresses to ground (windings, leads)

47



Electric Field Intensity in Hi-Lo Gap

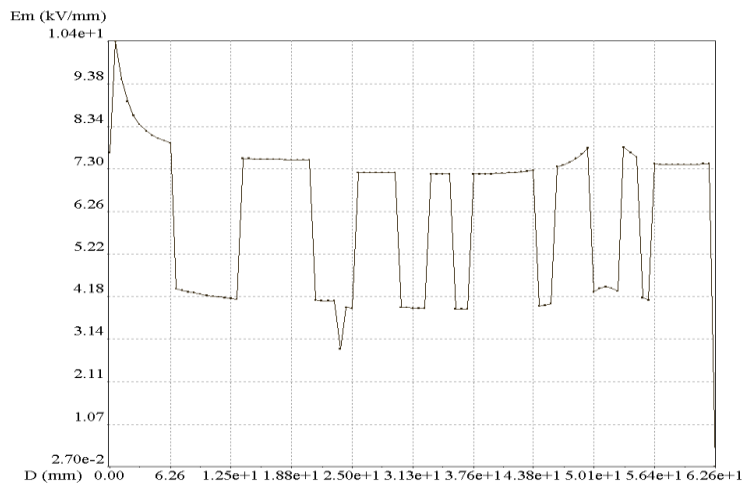

48



Comparison With Weidmann Curves

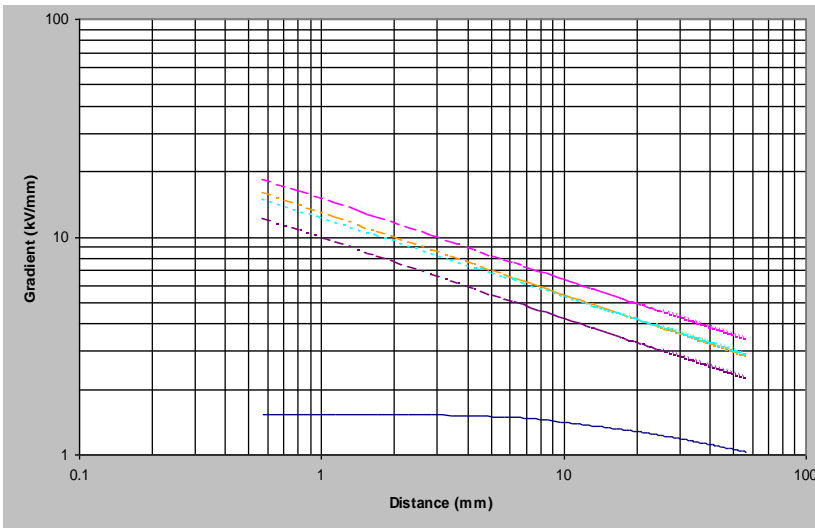

49



Transient Voltages in Tap Winding

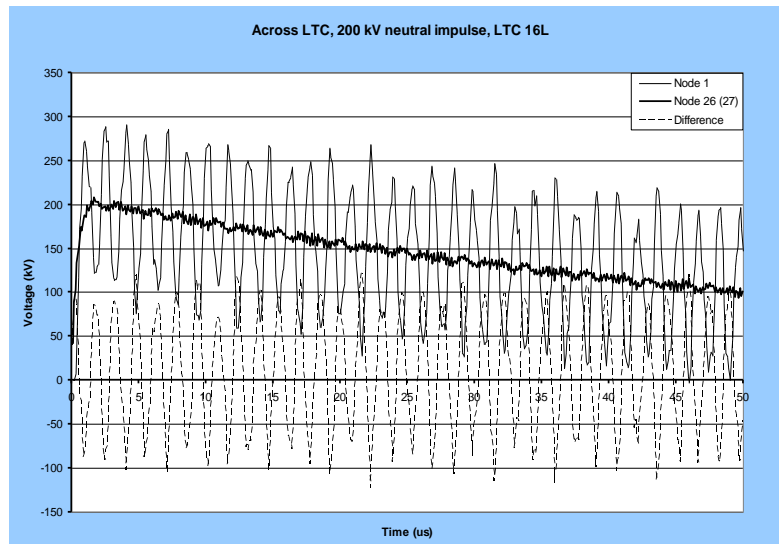

50



End Insulation - Electric Field Distribution



Smart solutions.
Strong relationships.

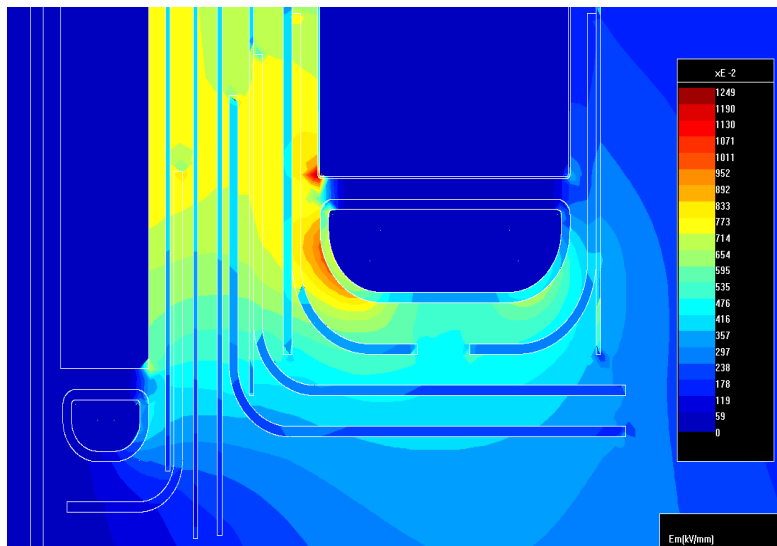

51



AVANTHA
GROUP COMPANY

Cooling Methods



Smart solutions.
Strong relationships.

Cooling medium

- *A - air cooling,*
- *O - oil cooling,*
- *K, L - cooling with synthetic fluid,*
- *W - water cooling*

Cooling mode

- *N - natural cooling,*
- *F - forced cooling,*
- *D - directed cooling (directed oil flow)*

e.g. *ONAN - oil natural, air natural - OA*
ONAF - oil natural, air forced - FA
ODAF - oil directed, air forced - FOA

52



AVANTHA
GROUP COMPANY

Directed and Non-Directed Oil Flow

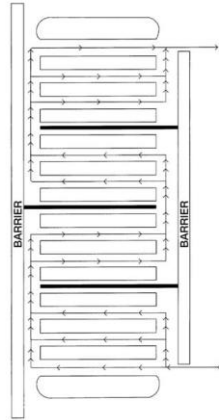

Directed

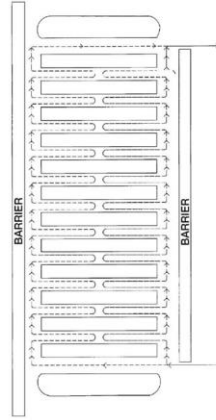

Non - Directed



Cooling



A) *ONAN, OA*
- Oil natural, air natural

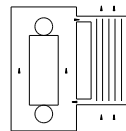

B) *ONAF, FA*
- Oil natural, air forced

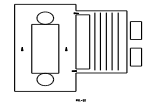
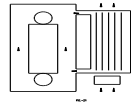

C) *OFAF, FOA*
- Oil forced, air forced

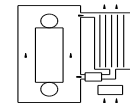
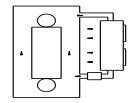

Cooling



D) ODAF, FOA

- Oil directed, air forced
- The oil is pumped and directed through some or all of windings

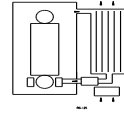

E) OFWF, FOW

- Oil forced, water forced

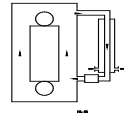

F) ODWF, FOW

- Oil directed, water forced

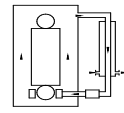

55



Tap Changers



- Load tap changers (LTC)
- De-energized type changers (DETC)
 - Bridging
 - Linear
 - Series/parallel
 - Delta/wye

56



DETC



Typically in HV w/adjustment of $\pm 5\%$, 4 steps

Bridging Type

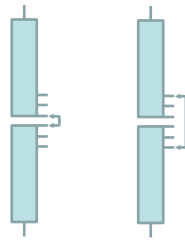

Linear Type

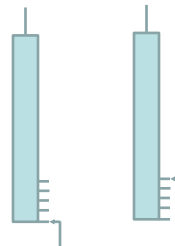

57



LTC



- (On) Load Tap Changer - switching under load!
- L.T.C. Switches
 - Resistive Bridging
 - Current limiting resistors
 - Reactive Bridging
 - Preventative auto-transformer (reactors)
- On tank & In tank
- Vacuum or Arcing in oil

58



Resistive - Type LTC

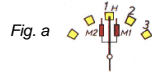

Position 1. The main contact H is carrying the load current. The transition contacts M1 and M2 are open, resting in the spaces between the fixed contacts.

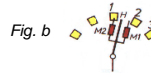

The transition contact M2 has made on the fixed contact 1, and the main switching contact H has broken. The transition resistor and the transition contact M2 carry the load current.

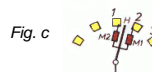

The transition contact M1 has made on the fixed contact 2. The load current is divided between the transition contacts M1 and M2. The circulating current is limited by the resistors.

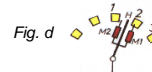

The transition contact M2 has broken at the fixed contact 1. The transition resistor and the transition contact M1 carry the load current.



Position 2. The main switching contact H has made on the fixed contact 2. The transition contact M1 has opened at the fixed contact 2. The main contact H is carrying the load current.



Reactor-type LTC

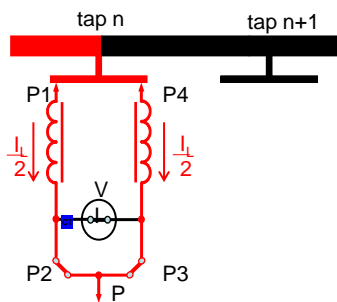

Non - Bridging

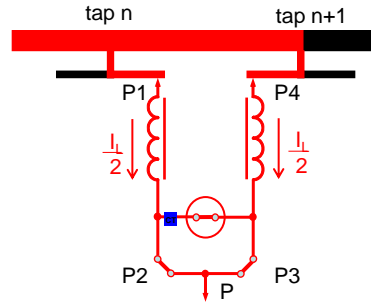

Bridging



Mechanical Design Overview

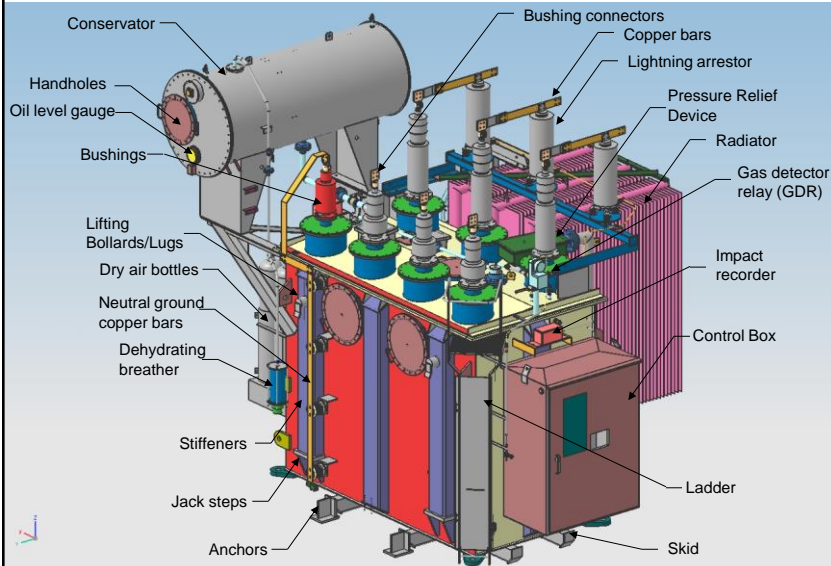

61



Tank Design



- contain the oil and serve as supporting structure

Two basic types of tank construction:

Conventional Tank

This type of construction has a top cover as shown.

Conventional Tank

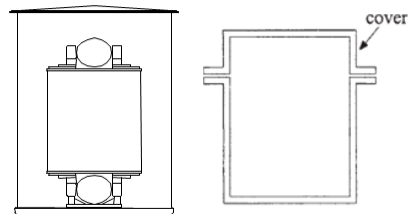

Bell Jar Tank

In this type of tank construction, the joint between the two parts is at the bottom yoke level to facilitate the inspection of core-winding assembly at site after the bell is removed.

Bell Tank

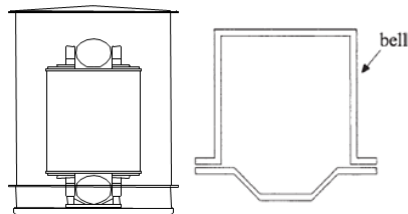

Tank Design



The transformer tank should be capable of withstanding the following loads:

1. Vacuum

- Maximum allowable deflection for the tank is $0.005 \times \text{span length}$

2. Lifting

- designed to facilitate handling of the transformer.
- Lifting bollards/lugs are used to lift the structure by a crane

Lifting Bollard

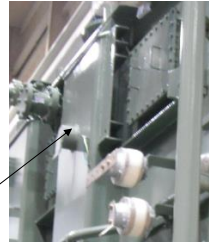

Bollard

Lifting Lug

Lifting Lug



Lug

Tank Design



3. Jacking

- designed to facilitate handling of the transformer.
- used for handling the transformer in the absence of crane, especially at the site

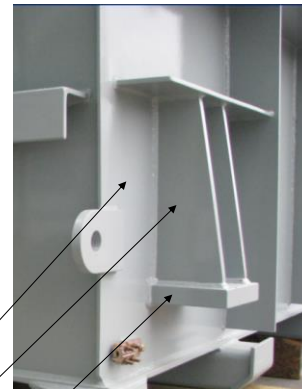

Tank Wall

Gussets

Jacking pad

Jack Step

Tank Design



4. Seismic and wind load:

- The transformer has to be designed for a specified seismic acceleration and wind load.
- are very important design considerations for bushings, supporting structures of conservator and radiators.

5. Transient pressure rise

- When an internal fault takes place, a large volume of decomposed gases may get generated due to arcing.
- Under these conditions, the tank structure has to withstand a rapid rise of pressure.

Sound Reduction

Other consideration to take into account when designing tank is to reduce sound generation

Tank Design



Base of Tank

- can be stiffened by formed channels or c-channels to reduce its thickness
- Designed to carry core-winding assembly weight, oil head and test pressure

Flat Base

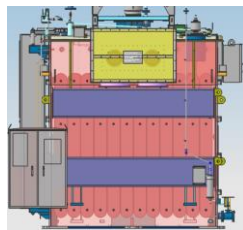

Skid Base

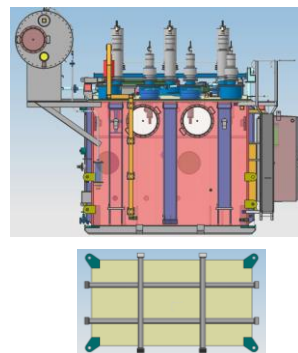

Transport Wheels/Skids



It is normally not practical to lift larger units by crane directly to final position.

- If a cast-in-rails system exist between unload area and final position, the unit may be equipped with wheels allowing it to be rolled in
- If no rail system exists, the unit is skided to final position

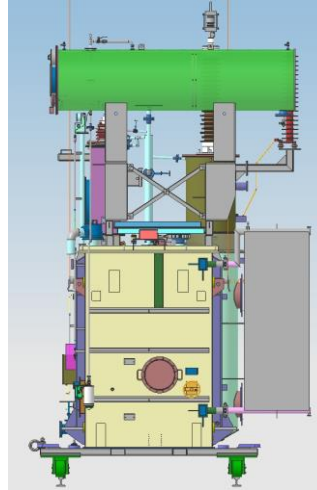

Rail System with Wheels

67



Tank Design



Cover of Tank

- Designed to withstand vacuum load
- Stiffened by formed channels, c-channels, or flat bars
- Many accessories are mounted on top of cover
- Type of cover:
 - Flat, Slope, Domed

Slope Cover

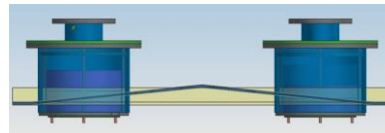

Domed Cover

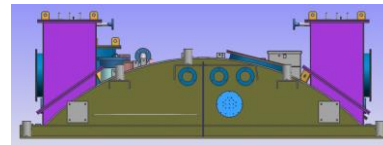

Flat Cover



Stiffener



The design of stiffeners is a very important aspect of tank design

- An effective stiffening arrangement can reduce the tank plate thickness.
 - Thus, tank weight is minimum.
- should be able to withstand the specified loads

Types of stiffeners used

- Formed channels
- Angles
- Bars

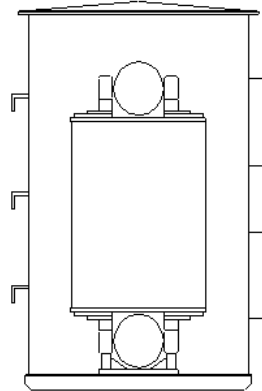

Vertical and Horizontal Stiffeners



540 MVA, 345/22 kV GSU



Oil Preservation Systems



Smart solutions.
Strong relationships.

GAS-OIL SEALED

- Free space (nitrogen gas or dry air) is provided in the tank for oil expansion
- The contact of oil with the outside atmosphere is totally eliminated.
- A positive pressure of 0.5 to 5 psi
- Advantage
 - Simple design, no conservators
- Disadvantage
 - Maintenance of gas system
 - Possibility for gas bubble generation, which reduces the dielectric strength
- Can only designed for a transformer up to 550 KV BIL

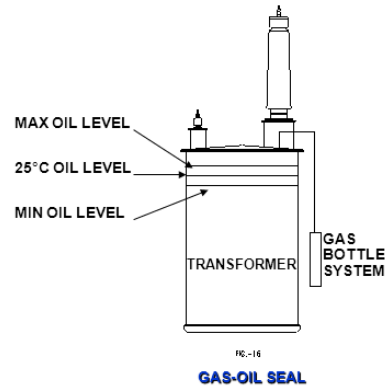

71

AVANTHA
GROUP COMPANY

Oil Preservation Systems



Smart solutions.
Strong relationships.

Conservator System

- Connected to transformer tank by piping.
- Can be provided with air bag
- Air bag
 - A synthetic rubber bag
 - occupies the space above oil to prevent air from contacting the oil
 - Internal of the bag is connected to atmosphere
 - Breathe in air when transformer cools and the oil volume is reduced
 - breathe out when transformer heats up.
- Air typically enters and exits through a desiccant-type air dryer/breather
- The main parts of the system are the expansion tank, air bag, breather, vent valves, liquid-level gauge, and alarm switch

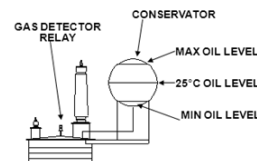
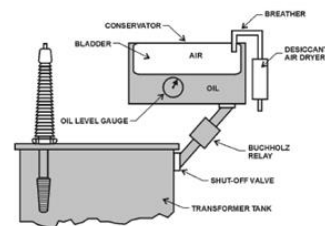

72

AVANTHA
GROUP COMPANY

Oil Preservation Systems



Conservator System

- Complete oil system in transformer
- Expansion tank
- Piping
- Dehydrating breather,
- Liquid-level gauge



73



3D Transformer Design

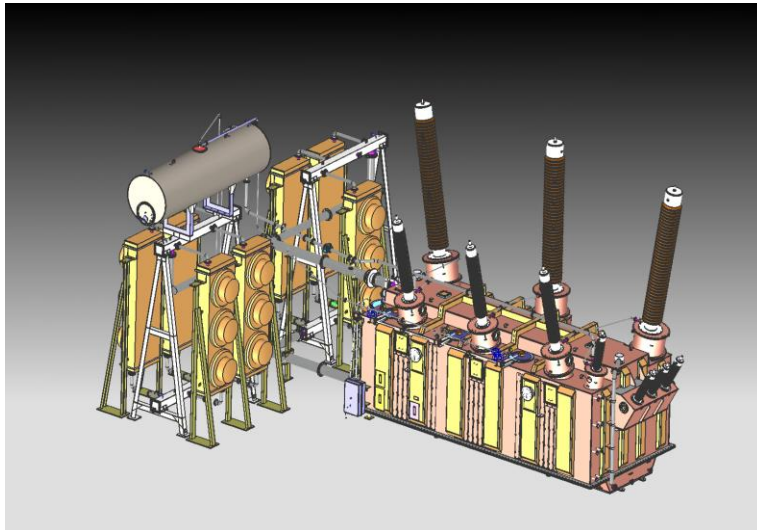

74



Transformer Product Visualization in UG



- *Downstream Visualization in Shop & Supplier*
- *Reduce/Eliminate 2-D Drawings*
- *Improve feedback mechanism*
- *Eliminate non value added activities on clarifications*

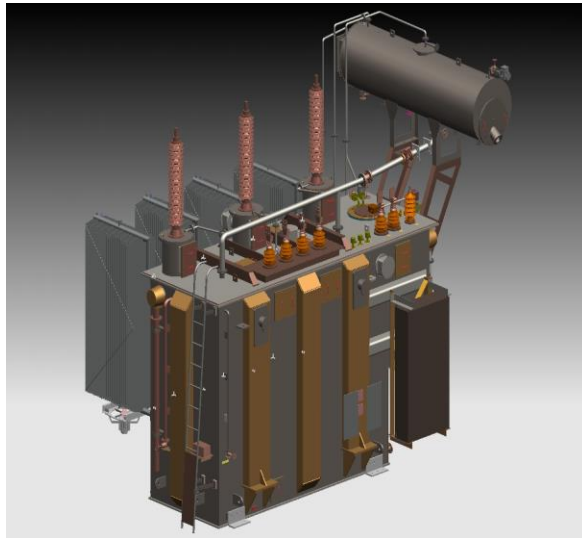

75



Design Example – HV Internal

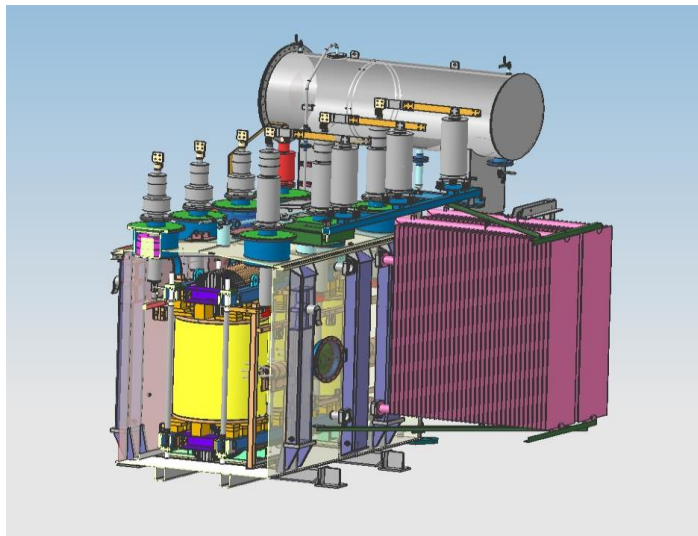

76



Design Example – LV Internal



Smart solutions.
Strong relationships.

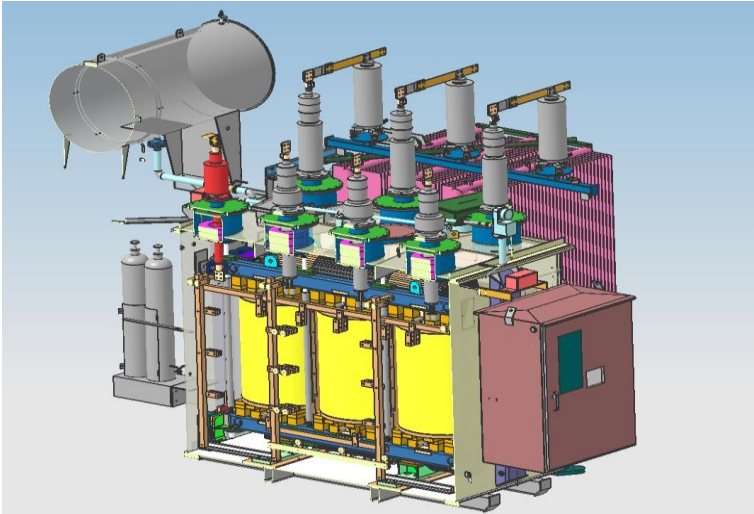

77



AVANTHA
GROUP COMPANY

Design Example – HV External



Smart solutions.
Strong relationships.

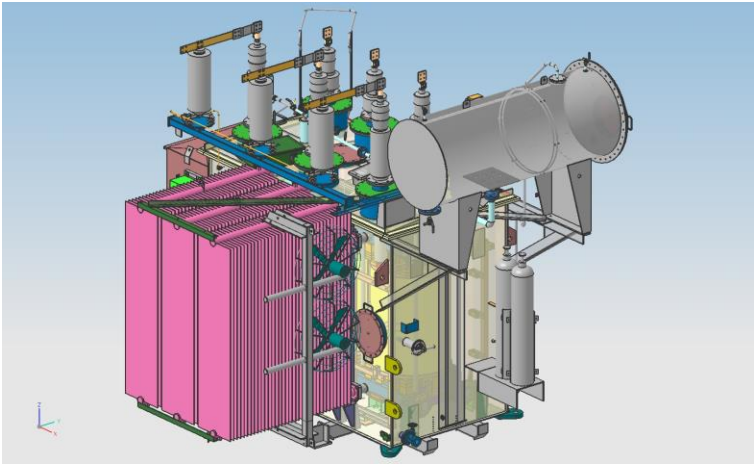

78



AVANTHA
GROUP COMPANY

Design Example – LV External

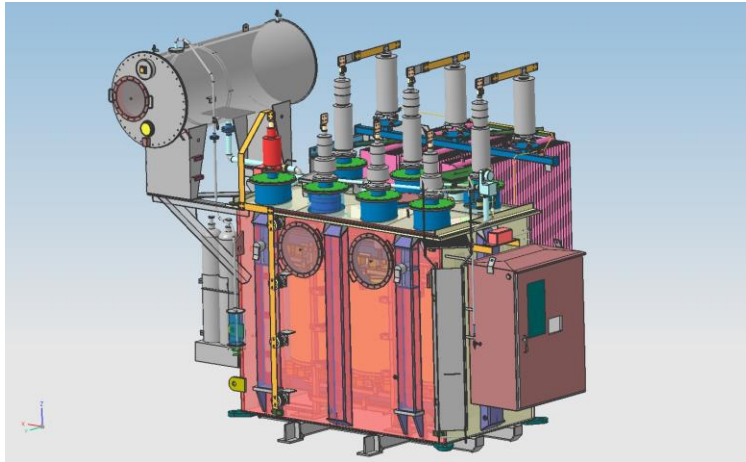

79



Finite Element Model - Deformation

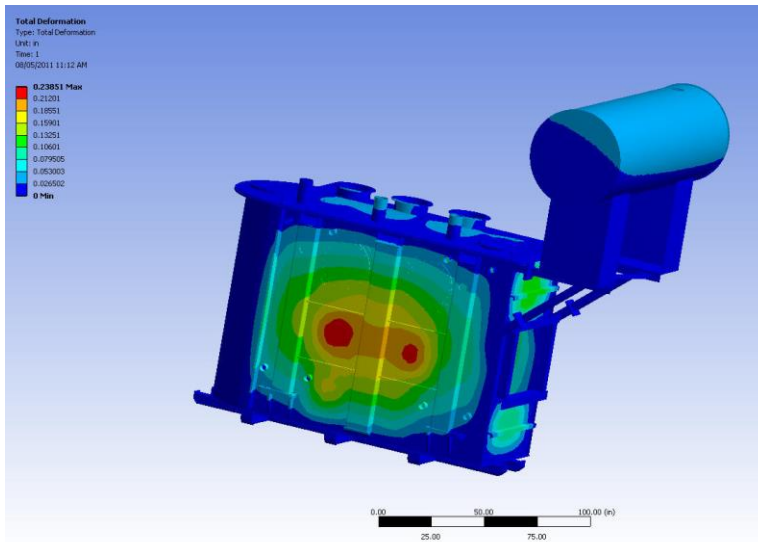

80



Finite Element Model – Safety Factor



Safety Factor
Type: Safety Factor - Top/Bottom
Time: 1
08/05/2011 11:11 AM

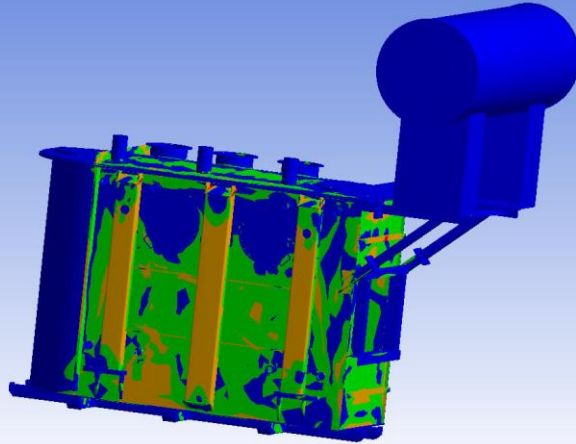

Finite Element Model – Equivalent Stress



Equivalent Stress
Type: Equivalent (von-Mises) Stress - Top/Bottom
Unit: psi
Time: 1
08/05/2011 11:11 AM

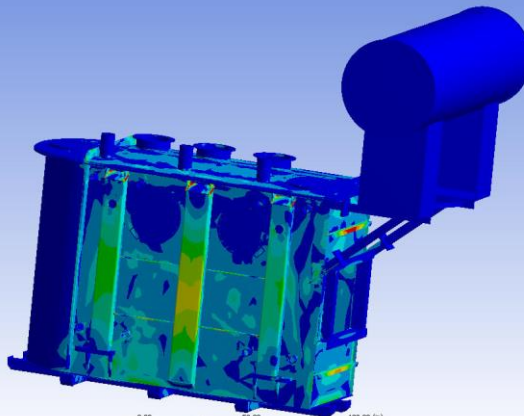
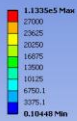

Deflection Plot Under Pressure Loading



Smart solutions.
Strong relationships.

Deflection in mm

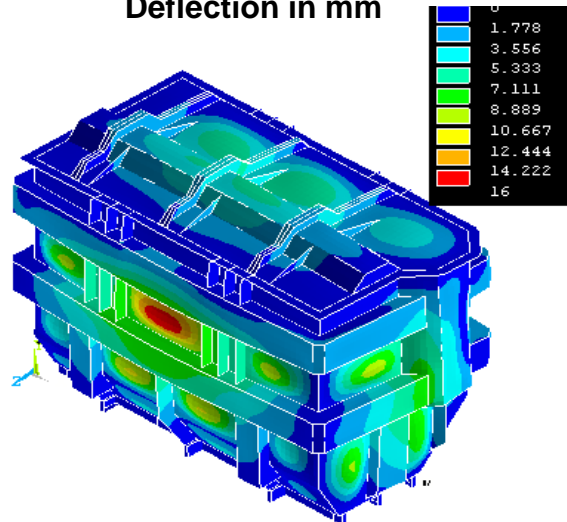

83



AVANTHA
GROUP COMPANY

Manufacturing Process



Smart solutions.
Strong relationships.

- Core Construction
- Insulation
- Windings
- Core and Coil
- Processing
- Testing
- Tanks
- Shipping

84



AVANTHA
GROUP COMPANY

Core Cutting – Georg 1000



85



Core Parts (Legs and Yokes) Stacked

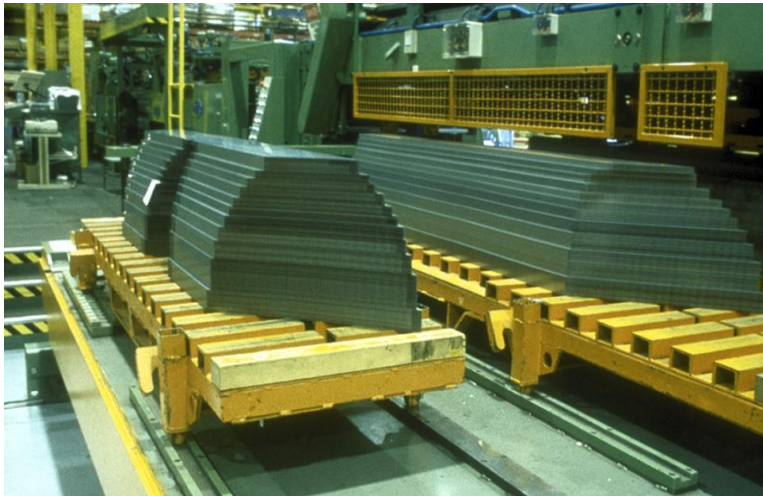

86



Core Stacking



- *Use of temporary bolt guides for stacking*
- *2, 3, 4 & 5 leg cores manufactured for single & three phase units*



87



Core Stacking



- *Oil ducts utilized to control temperature rise*
- *Temporary, Permanent or combination of banding*



88



Coil Assembly

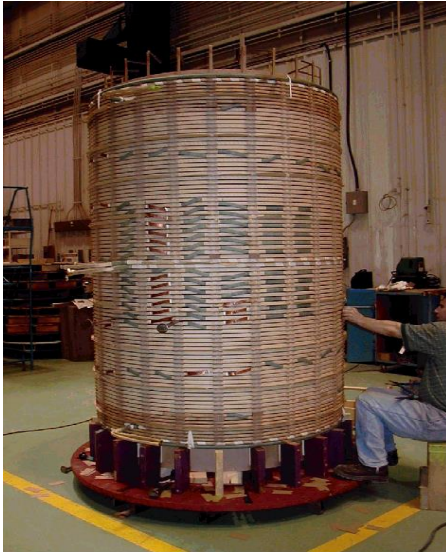

- *Winding type*
- *Conductor Type*
- *Insulation components*

89



Complete Winding Insulation Package



90



Coil & Core Assembly



- *Coils lowered over core*
- *Top coil to clamp insulation*
- *Top clamps*
- *Top core inserted*

91



Coil & Core Assembly



- *Windings are clamped using external or internal tie rods to provide additional support for axial forces*
- *Leads and busbars are rigidly supported to withstand forces from shipping & short circuits*
- *Assembly moved on air cushions*



92



Tank Shop



- *Cleaned, priming and painted*
- *Inside painted white*
- *Shunt Packs*

540 MVA, 345/22 kV GSU

93



Tank Covers



- *Raised flanges*
- *Domed cover*
- *Mild steel plate w/Inserts*



94



Vapor Phase

- *Core and coil assembly - kerosene vapor cycle drying*
- *Power factor & water extraction - continually monitored*
- *Kerosene is vaporized*
- *Water & Vapor drawn by vacuum into autoclave*



95



Re-Pack & Tanking

- *Re-packed, final hydraulic clamping*
- *Limited exposure time*
- *250 ton over head crane*



504 MVA, 230/115 kV Auto

96



Testing

- All Industry standard tests :
 - ✓ Routine Tests
 - ✓ Loss Measurement and Temperature Rise tests
 - ✓ Dielectric tests
 - ✓ Zero-phase-sequence
 - ✓ Audible Sound Level
 - ✓ Short-circuit tests, if required (performed at the IREQ lab)

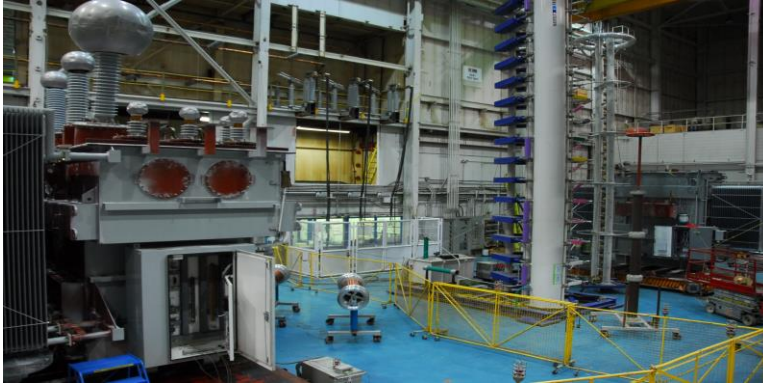

97



Securing Transformer for Shipping



PacifiCorp 540 MVA, 345/22 kV GSU

Securing the transformers are performed according to AAR rule

AAR – Association of American Railroad

New document: IEEE Std C57.150

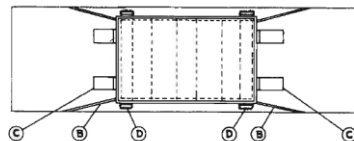

Steel bars are welded to secure the transformer

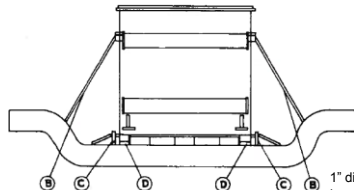

1" dia. tie rods are used to secure the transformer

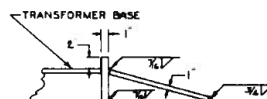

IEEE Std C57.150-2012 Guide for transportation



IEEE Guide for the Transportation of Transformers and Reactors Rated 10,000 kVA or Higher – major topics covered are as follows:

- Request for quotation and specification
- Design Considerations for Transport
- Transportation preparation (Main transformer or reactor, tank accessories)
- Planning for heavy haul transportation
- Transport (Transportation information, terminology, Barge and ocean vessels, Rail, Air cargo, Arrival at destination, dielectric fluid)
- Heavy haul transportation (Condition of heavy haul equipment, Inspection of equipment prior to receiving, Offloading the equipment onto heavy haul transportation equipment, Securing the load, Transportation to the destination)
- Arrival (receipt) inspection

99



IEEE 57.150 – six degrees of motion at sea



Linear or Axial Motion

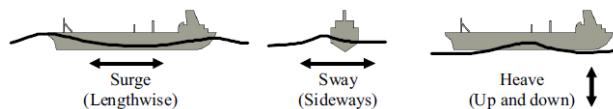

Rotational Motion

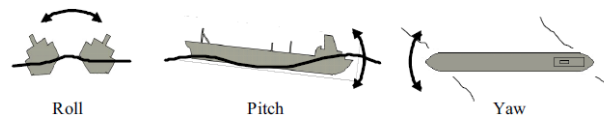

Vessels underway at sea will experience wind and wave conditions that cause six degrees (or freedoms) of motion.

Three degrees of motion are rotational: the side to side rotation is called “roll,” the fore to aft rotation causing the bow to rise and fall opposite to the stern rising and falling is called “pitch,” while turning or rotation about the vertical axis is called “yaw.”

Three degrees are linear or axial: In combination or separately, the vessel may experience forth to aft acceleration/deceleration called “surge”, sideways movement called “sway,” and “”, vertical movement called “heave”.

100



IEEE 57.150 – design aspects



‘ The design and shipping details of new transformers and reactors should be addressed during the design phase and prior to the manufacture to address all aspects of transport from factory to final pad. The equipment should be designed to allow transportation by both rail and truck, as well as by ocean vessel, barge, or air cargo when appropriate.

The core legs should have a solid support from the bottom to the top clamp to prevent sideways deformation and bulging of the outermost laminations. The core should be adequately braced to the core clamping structure, so that it cannot move in any direction. The windings should be tight to prevent movements relative to the core. The core and coil assembly and other internal components should be supported by permanent bracing to the interior of the tank. Temporary transportation braces for the core and coil should not generally be required, and should only be allowed with special approval and instructions for use formally documented.

Temporary transportation supports may be required in some units (e.g. units that will be subjected to long sea voyages, shell form, or other units shipped in a laid down position), or for current transformers, leads, bushing supports, and other ancillary items.’

101



Schnable – Road Trailer



102



Field Assembly

- *Unit has been skidded onto foundation*
- *fully assembled.*
- *Vacuum processed*
- *Oil filled with approx. 29,000 imperial gallons*



700 MVA, 345 kV, Auto
Shipping Wt. 524,000 LB
Total Wt. 670,470 LB

103



Thank You!