

KATO ENGINEERING™

By LoKiLeCh - Own work, CC BY 3.0,
<https://commons.wikimedia.org/w/index.php?curid=12879005>

Synchronous Generators -- Odds and Ends -- a Cabinet of Curiosities

Presenter - Allen Windhorn
Support - Bryan.Baum@mail.nidec.com

IEEE Houston CED Seminar – January 9 & 10, 2018

Contents:

1. Arc-Flash Energy
2. Leading Power Factor, Harmonics, and UPS Loads
3. Grid Codes
4. Power Systems – Symmetrical Components and Per-Unit
5. Reference Frame Theory: Generator Models and Park's Equations
6. Excitation System Models and Exciter Response
7. Decrement Curves
8. Synchronization and Paralleling
9. Ten Common Questions for Specifying Generators

1. Arc-Flash Energy

Key Messages

- **IEEE Std 1584-2002 does not address the special nature of arc flash energy from synchronous generation sources. It is based on electrical sources having fixed impedance, hence constant arc current.**
- **Because the arc current from a synchronous generator changes with time, circuit protective devices may clear the fault earlier or later than expected. Calculations based on constant arc current may overestimate or underestimate the incident energy, leading to unforeseen hazards.**
- **Ship power is nearly all provided by synchronous generators, so no method to calculate arc energy**
- **A tentative method is presented to account for the changing current, based on methods in IEEE Std 242 to estimate fault current vs. time. We recommend the incorporation of some such similar method in IEEE 1584.**

Fault Currents of a Synchronous Machine

- **IEEE Std 242 provides a simplified method to calculate current into a “hard” three-phase fault applied suddenly and with constant excitation**
- **Symmetrical three-phase fault (as required by IEEE 1584) is the sum of two decaying exponential functions plus a constant term**
- **Modifications of this method provide for voltage regulator action that increases excitation following application of the fault**
- **To simplify, regulator action will be considered only on the constant term (since other terms are decaying)**

Fault Currents of a Synchronous Machine

- Equation for AC bolted fault current:

$$i_{ac} = (i_d'' - i_d')e^{-\frac{t}{T_d''}} + (i_d' - i_d)e^{-\frac{t}{T_d'}} + i_d e_i$$

where:

$$i_d = \frac{e_t \frac{I_F}{I_{Fg}}}{X_d}$$

$$i_d' = \frac{e_i'}{X_d'}$$

$$i_d'' = \frac{e_i''}{X_d''}$$

Fault Currents of a Synchronous Machine

- **Using rated voltage in lieu of “internal” voltage. This has a secondary effect on the energy, so should not lead to a large error**
- **As a reasonable approximation, the arc power may be calculated at discrete time steps using the available bolted fault arc current as calculated above at each instant, and calculating the arc power at each time step using IEEE Std 1584 [6]**
- **Numerically integrating the arc power over the duration of the arc will give the total arc energy**
- **Better methods are needed. Full machine simulation may be an option with modern computers and standard arc fault models.**

- **IEEE 1584 uses single fault current value to calculate an arc fault current based on factors which include voltage and physical layout**
- **The same calculation may be made continuously based on the variable available fault current from the alternator**
- **Voltage should be voltage behind the reactance of the generator:**
 - **Which of the various “voltages” of the decrement curve equation should be used?**
 - **Should be the voltage that would appear “instantaneously” on the generator terminals (disregarding the effect of sudden current change on the internal inductances) if the fault and load were suddenly removed**
 - **Depending on excitation at the given instant, may be more or less than rated terminal voltage. A method for calculating this voltage, especially in a power system with diverse sources, has not been developed (apart from full simulation).**

References

- [1] Institute of Electrical and Electronic Engineers, Std 399, Recommended Practice for Industrial and Commercial Power Systems Analysis, New York: IEEE, 1997.
- [2] P. M. Anderson and A. A. Fouad, Power System Control and Stability, Wiley-IEEE Press, 2002.
- [3] Westinghouse Electric, Electrical Transmission and Distribution Reference Book, 1944.
- [4] P. Krause, O. Wasynczuk and S. Sudhoff, Analysis of Electric Machinery, New York: IEEE Press, 1995.
- [5] Institute of Electrical and Electronics Engineers, "Std 242, IEEE recommended Practice for Protection and Coordination of Industrial and Commercial Power Systems (Buff Book)," IEEE, New York, 1986.
- [6] Institute of Electrical and Electronics Engineers, "Std 1584, IEEE Guide for Performing Arc Flash Hazard Calculations," IEEE, New York, 2002.
- [7] National Fire Protection Association, "NFPA 70E Electrical Safety in the Workplace," NFPA, Quincy, MA, 2015.
- [8] IEEE, "IEEE recommended Practice for Protection and Coordination of Industrial and Commercial Power Systems (Buff Book)," Institute of Electrical and Electronics Engineers, New York, 1986.

2. Leading Power Factor, Harmonics, and UPS Loads

2a. Leading Power Factor

Operation at Leading Power Factor

Generators operating with a leading power factor may experience unstable voltage regulation and increased heating. The following paragraphs define power factor and describe various generator characteristics that impact operation with a leading power factor load.

An understanding of the load being powered by the generator allows the generator supplier to work with the customer to choose a generator and system design that will provide trouble free operation.

Suggestions for specifying a generator for leading power factor operation are provided.

Excitation of Synchronous Machines

- In synchronous generators a stator (armature) winding produces voltage in response to a magnetic field produced when a rotor winding is “excited” by field current
- Increasing field current increases the magnetic field resulting in increased voltage
- Adding load to the generator changes the amount of field current required to maintain the voltage at setpoint
- Lagging power factor load *increases* the required field current; Leading power factor load *decreases* the required field current.

- Remember the power factor triangle: it is the same for leading or lagging power factor except for the sign of the reactive power.
- At some value of leading power factor load, the field current required to maintain voltage decreases to zero. At this point, there is no ability to control voltage and the generator voltage will increase until saturation stops it.
- If the generator is paralleled with a grid, the effect is different. Since voltage is controlled by the grid, it doesn't increase. Without field current, the generator can't provide torque, so it will become unstable and slip poles.

Excitation of Synchronous Machines

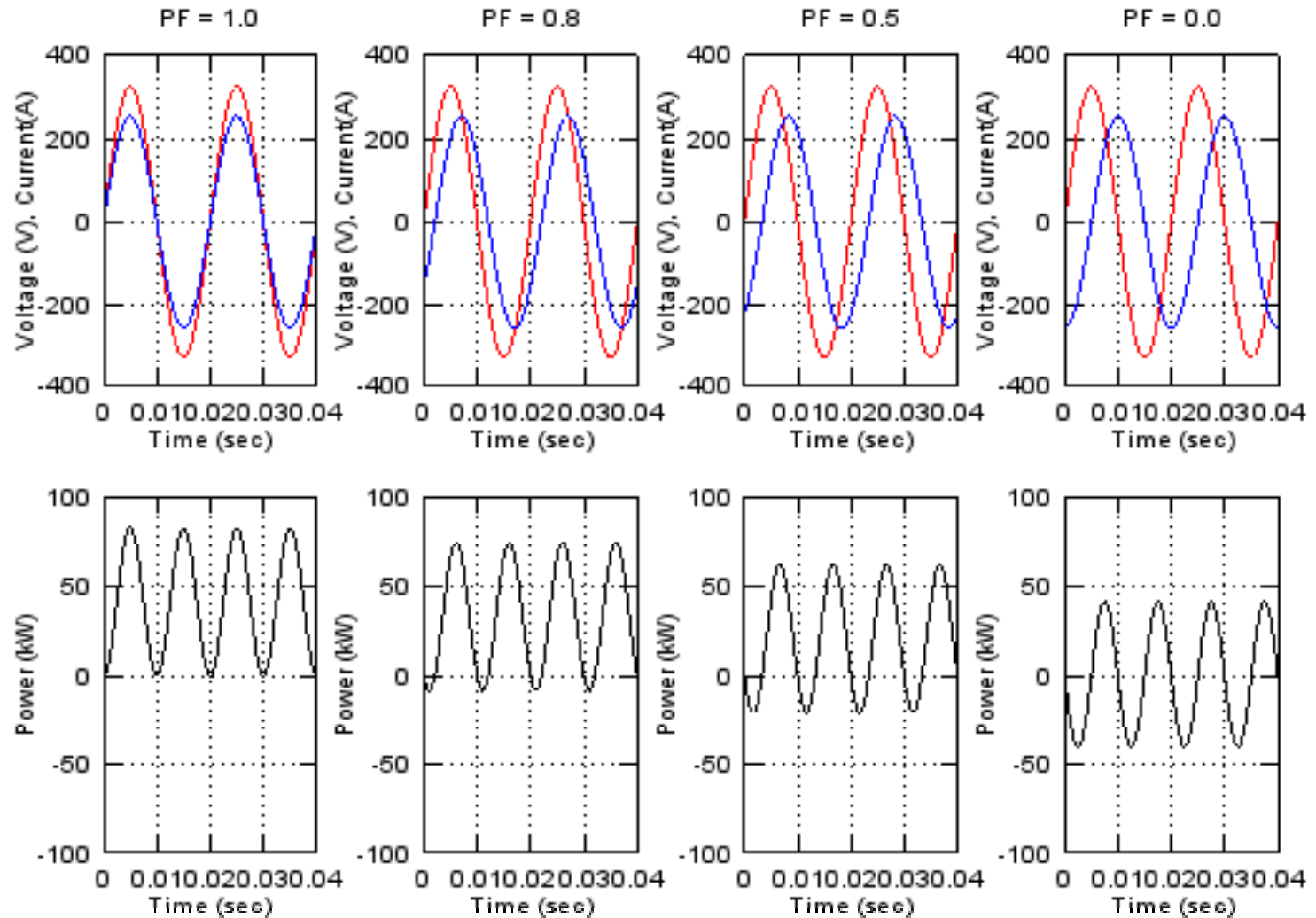

Excitation of Synchronous Machines

- Sometimes referred to as “reverse VARs”
- This is *not* the same thing as “negative power factor” or “reverse power”, which is controlled by the engine, not the generator
- “Pole slipping” can cause severe voltage disturbances and will result in rapid heating of the generator if unchecked

Reactive Capability Curves

- The interaction between field current and output voltage and current is complex, especially when saliency and saturation of the magnetic material are considered, so usually simplified but conservative rules are used to determine generator sizing
- The tool most commonly used to determine excitation limits is the reactive capability curve, which is derived from these simplified rules

Reactive Capability Curves

- The generator parameters that control this are saturated short-circuit ratio (SCR or, in Europe, K_{sc}) and saturated synchronous impedance X_{ds} . These both represent the same quantity and are reciprocals of each other.
- High SCR and low X_{ds} make the machine more stable. To a first approximation, if X_{ds} is less than 1, or SCR greater than 1, the machine will be stable with any leading power factor down to zero.
- To achieve this usually requires a considerably oversized machine

Reactive Capability Curve

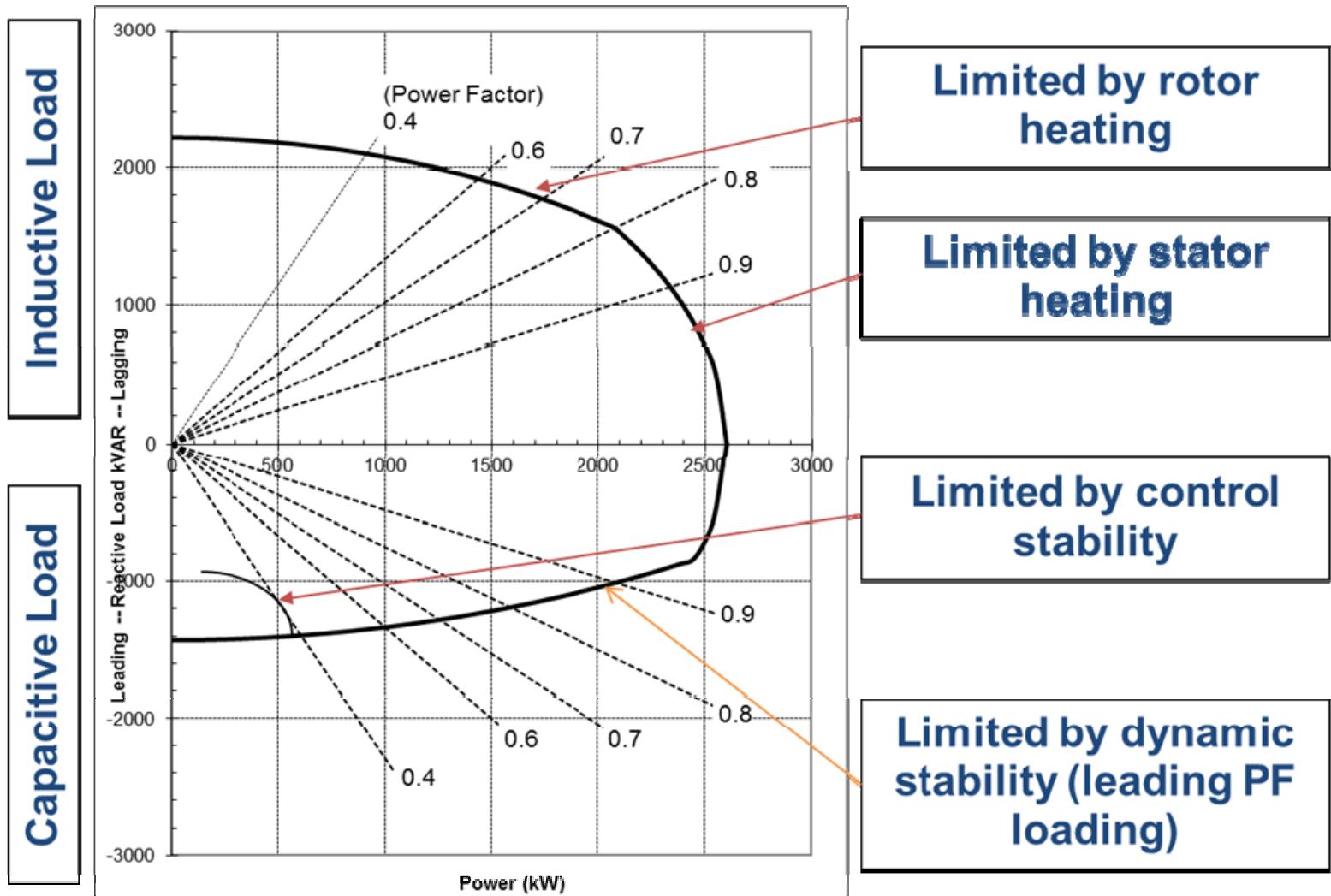

Reactive Capability Curves

- With lagging power factor, the limits on generator output are caused by heating. At leading power factor, on the other hand, the limits are concerned with the stability of the machine, meaning its ability to supply power at a steady rate at constant speed and voltage.
- For large or high-speed machines there may be a limit on leading power factor due to heating of the end regions of the rotor. We have never observed this in the kind of machines we build.

Reactive Capability Curves

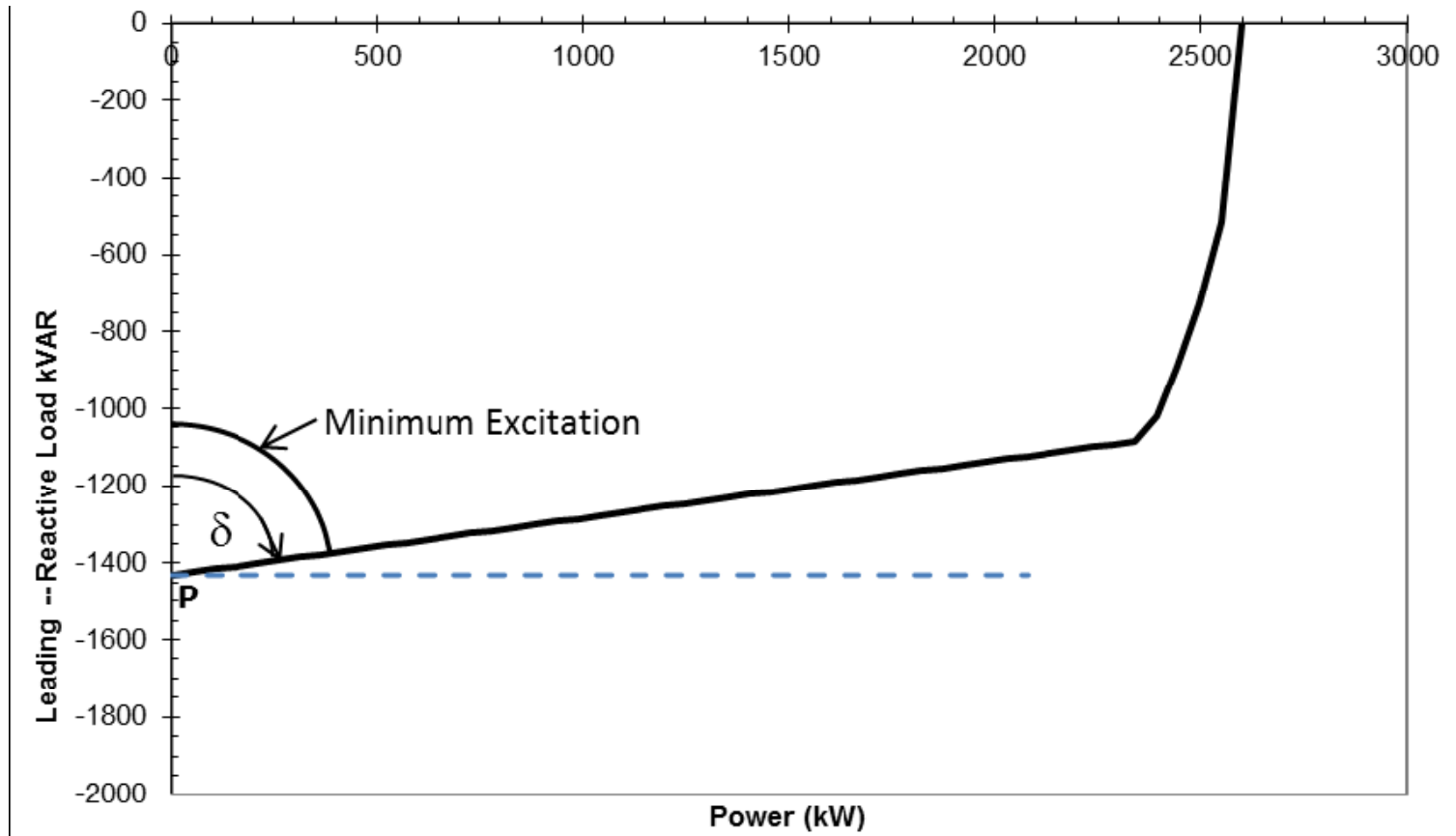

Illustration of Minimum Excitation and Angle delta

Reactive Capability Curves

- Each manufacturer decides what criteria to use to draw this curve, and there is no standard procedure
- The intersection of the leading power factor curve with the negative Y axis is located at about -1430 kVAR, which is just the kVA rating (2600 kVA) times the short-circuit ratio SCR (0.55). This represents the point where the excitation becomes zero with no real load. We will call this point P. It is not a practical operating point, but with a modern digital regulator it is possible to come close.

Reactive Capability Curves

- The distance from P to the operating point, divided by the absolute value of Y at point P, is approximately the per-unit excitation current (where 1 PU represents the no-load unsaturated excitation)

Preferably, the generator OEM and the user (or site engineer) should work together to select a generator design that will meet the requirements of the site. In addition to the normal rating data, the manufacturer will benefit from the following information:

- Whether the site will run in island or grid-connected mode, or both
- In island mode, what sort of capacitive load will be connected, and how it will be coordinated with other loading

- For example, large UPS sets will generally have a fixed capacitive reactance on the input due to the input filters, but these UPS sets will have variable real power load depending on how their output is loaded. Other loads on the circuit (e.g. chillers) may provide lagging load to counterbalance the leading load, but if they are started *after* the leading load, the system must be stable without them.

How to Specify Generators for Leading Power Factor

- In grid-connected mode, the user has control over the VAR loading, but if leading power factor operation is required (possibly for local voltage control at light load), the generator manufacturer needs to know the possible range of real and reactive loading

How to Specify Generators for Leading Power Factor

To meet the site requirements, we may:

- Propose an oversize generator in order to keep the synchronous reactance low
- Use a special design that is more saturated than normal for the same reason
- Include special testing to insure that the generator will meet requirements
- Propose additional protective relaying and controls to detect or prevent unstable conditions

How to Specify Generators for Leading Power Factor

- At a minimum, a reactive capability curve as well as saturation curves and V-curves should be requested for the proposed generator before ordering, and carefully examined by the site engineer to make certain the generator will always operate within the safe region
- Because the leading power factor capability depends strongly on factors that vary by manufacturer, frame size, pole count, and model, it is not possible to use a “rule of thumb” for sizing the generator

2b. Harmonic Loads

Harmonic Loads – Sizing Factors

- To meet temperature rise:
 - Type of load:
 - Linear
 - Non-linear:
 - Type of load (e.g. six-pulse diode rectifier) or percentage of rated current for each harmonic
 - Filtering and impedance
- To meet voltage distortion requirements:
 - Need measured harmonic currents and frequencies
 - Is an estimate only since actual result depends on system factors other than generator impedance

Harmonic Loads (cont.)

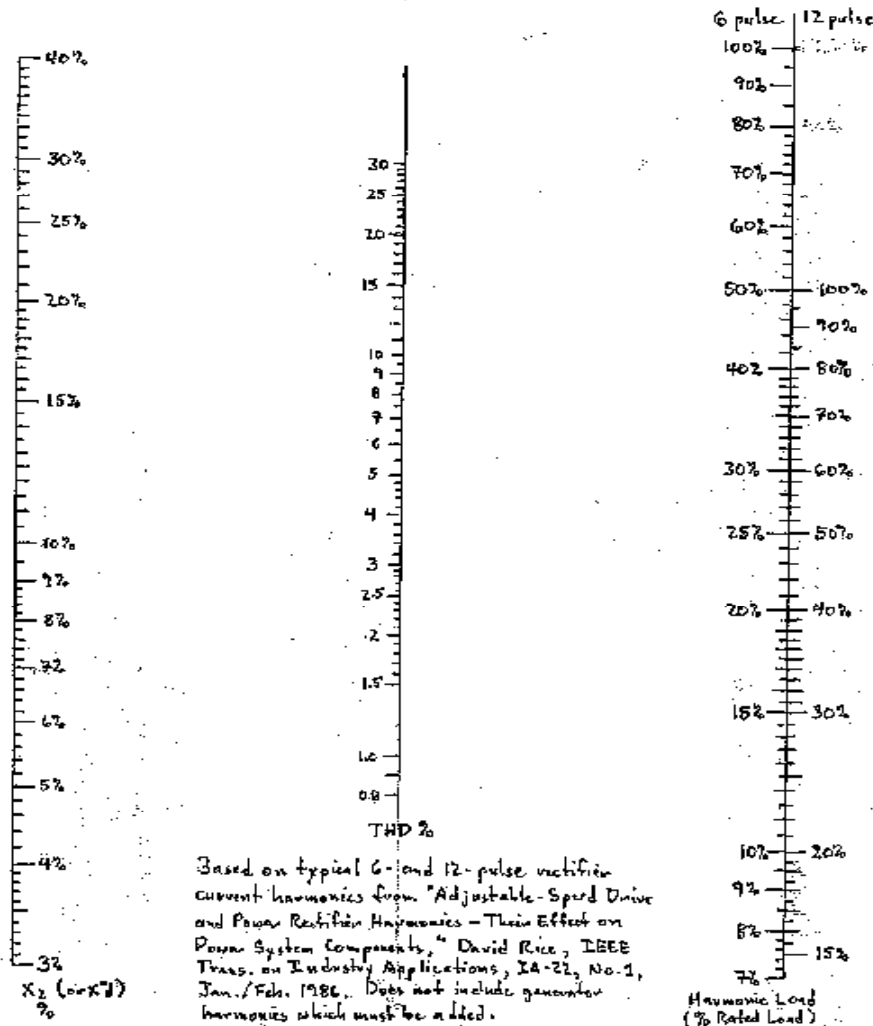

AW
14 May 2003

Harmonic Loads (cont.)

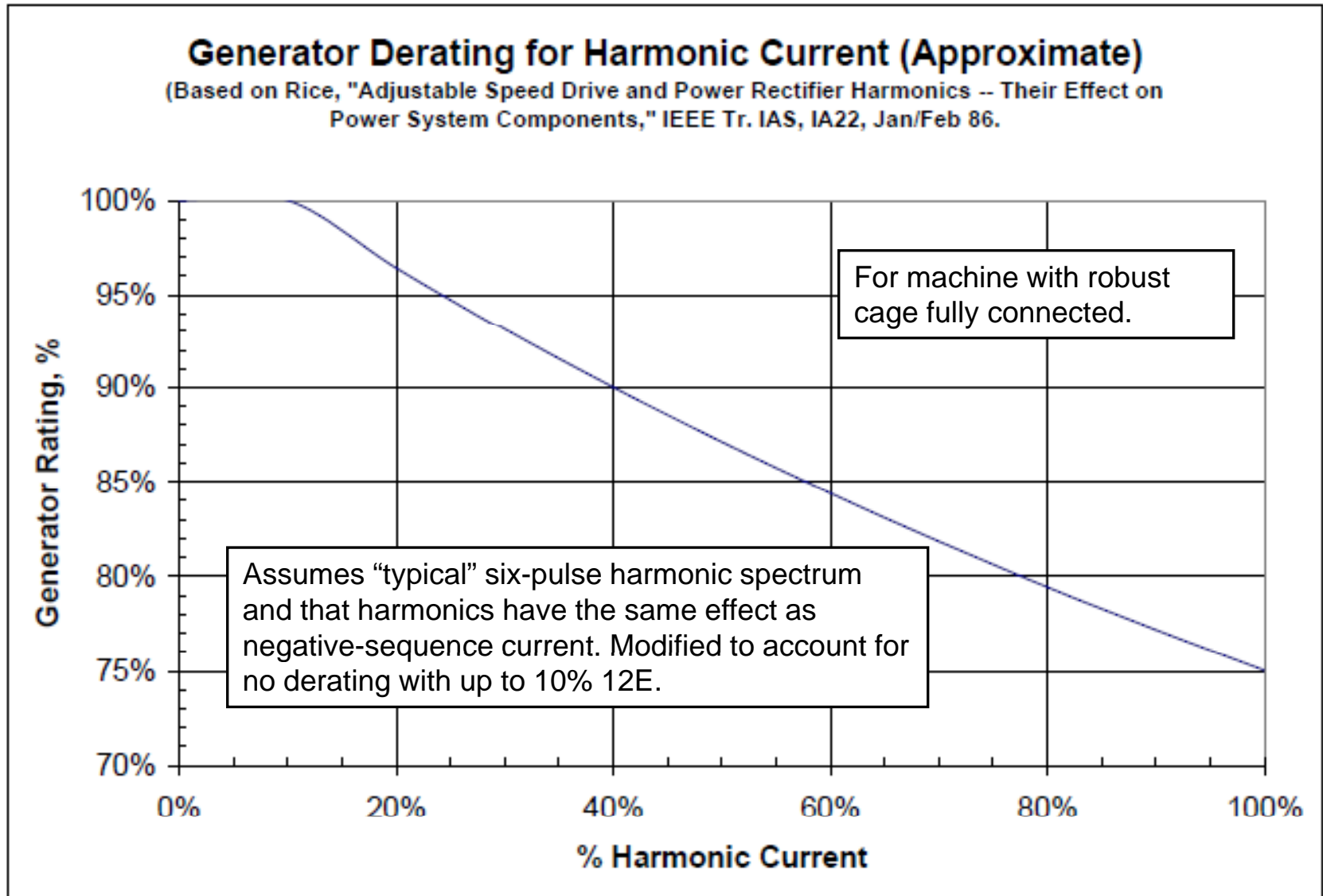

2c. UPS Loads

Sizing for UPS Loads: (1) Types of UPS

- Standby: passes AC power from mains directly to the load, little or no conditioning
 - Only effect on generator is the battery charger
- Line Interactive: feeds AC power to the load, but with conditioning and voltage regulation
 - Filters and voltage regulation equipment may have an effect on the generator
- Dual Conversion: Power to the load is always generated by the UPS, isolated from the line
 - Input rectifier is always on-line, with leading power factor and/or harmonic effects on generator present continuously

Sizing for UPS Loads: Standby UPS

- Older systems may have SCR or six-pulse battery charger, causing some current harmonics
- Manufacturer's data or actual measurements of harmonic currents and frequencies (or a waveform capture), *while the charger is actively charging the battery* (preferably under low-battery condition), will be helpful

Sizing for UPS Loads: Line-Interactive UPS

- Line Interactive: usually has an input inductor to provide some line isolation, followed by an active solid-state or rotary power conditioner
- The input inductor and the power conditioning device will interact to cause highly variable power factor in order to regulate voltage. When powered by a generator, there will not be much voltage variation, so little effect.
- Refer to the previous slide on battery chargers

- Effect of the UPS will depend on the input circuit, and what filtering is provided
- UPS with passive rectifier may present high current harmonics to the generator. 12- or 18-pulse will be better than six-pulse.
- Passive filters may be provided to reduce the current harmonics. The capacitors in these filters are connected across the input of the UPS and cause a leading power factor. The generator must have stability under this load (see section on leading power factor)
- “Active front end” (AFE) UPS systems usually don’t cause these problems

- Most UPS systems draw constant power (for a constant load) from the mains. This means when the input voltage rises, the current goes down, and when the voltage falls, the current increases. This “negative impedance” effect will reduce the stability of the power system, but generally not enough to cause problems with a fast excitation system, even with 100% UPS load.
- Voltage dips due to motor starting or block loading may cause the UPS to switch to battery unnecessarily. This causes deterioration of the battery. Sizing the generator to keep the voltage dip within UPS limits, or changing UPS settings and delays, will prevent this.
- See white paper for additional information

3. Grid Codes

There are a *lot* of slides here and we will go through them *very fast*, so if you need to pause or go back, shout it out.

GRID CODE

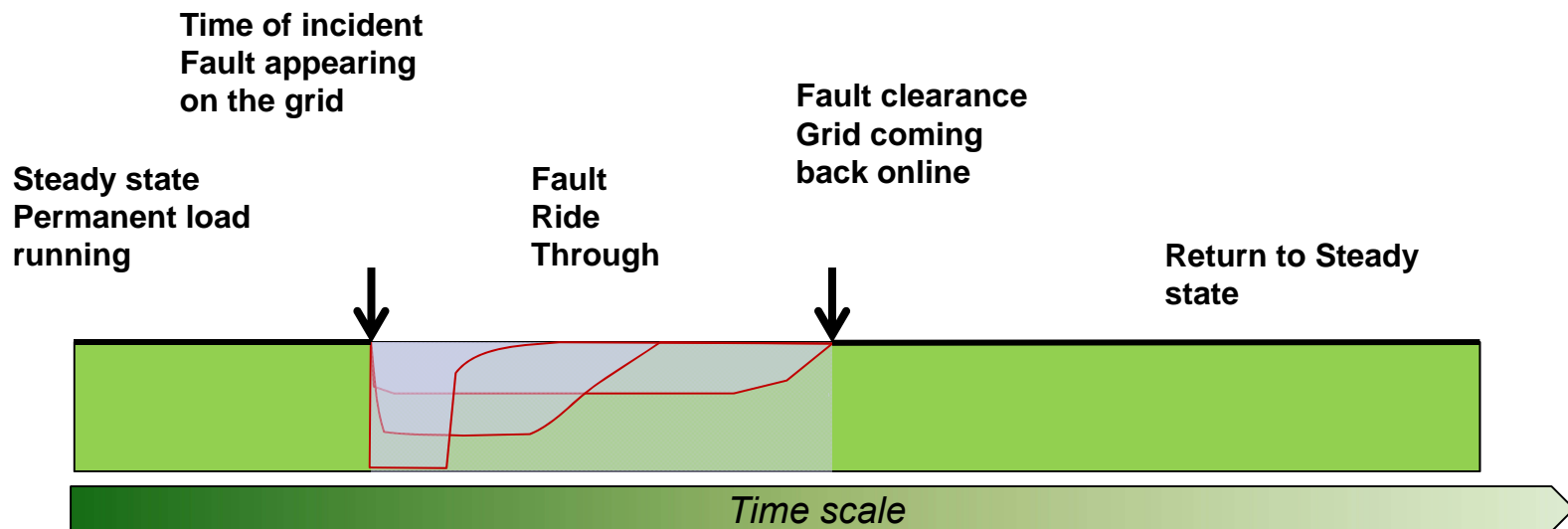

- What is a Grid Code, why new grid codes and consequences ?
- Impact of the Grid Code on sizing:
 - Static
 - Dynamic
 - LS guidelines and basic recommendations
- Fault Ride Through risk and behavior
- Case studies

What is a grid code ?

- A **grid code** is a technical specification which defines the requirements for a generating set to be connected to a public supply network. How it meets, safely, securely and economically a correctly functioning electrical system.
- The grid code is specified by an authority responsible for the system integrity and network operation. This is either a rule, a law or a standard, depending on each country.
- All generators are concerned whatever the driving system and whatever the power rating

Why is there a new grid code ?

- The increasing intermittent power generation (due to increasing wind farm installations or photovoltaic plants) and more micro-power plants leads to more instability of the grids
- Previously, these power suppliers were supposed to protect themselves first in case of fault conditions (short circuit...)
- The grid supervisors demand from power suppliers to remain connected to the grid in case of trouble on the distribution line bus bars and also to contribute to the network stability when there are:
 - Instabilities (regarding voltage & frequency)
 - Voltage sags
 - (Micro) short circuits, etc.
- This means that, at least, the Protection strategy & the Genset control sequence must change

- Under the « Grid Code » label, we include all possible requirements related to the constraint of connecting a genset to a public supply network
- Rules have changed over the past years and will continue to change
- New regulations appear in each country
- Impact on the genset is related to both running conditions:
 - static : enlarged running condition in steady state
 - dynamic : Fault Ride Through (FRT)

- Regarding the static perspective...
new « Grid Code » requirement is affecting:
 - Voltage range
 - Frequency range
 - Power capability

Grid Code Impact... : Voltage range

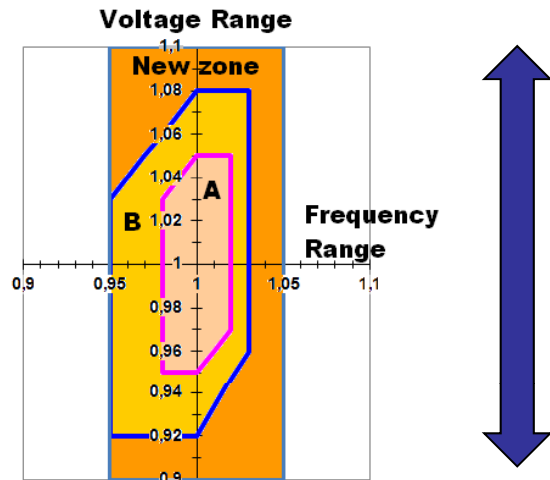

- Previously, we considered that the « Grid » was strong and maintaining the voltage within +/- 5%. Operating outside of this range was considered unusual and de-rated performance was accepted (refer IEC60034)
- Now, « Grid Code » will require operating over a wider voltage range, usually up to +/-10%
- Impact for the alternator: enlarging the voltage range could lead to a different sizing of the alternator...

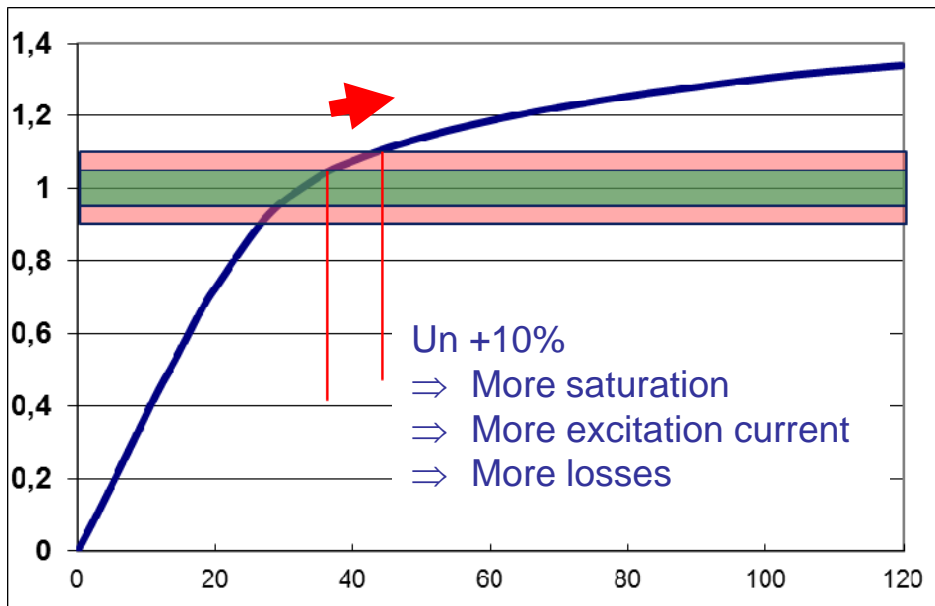

Grid Code Impact... : Frequency range

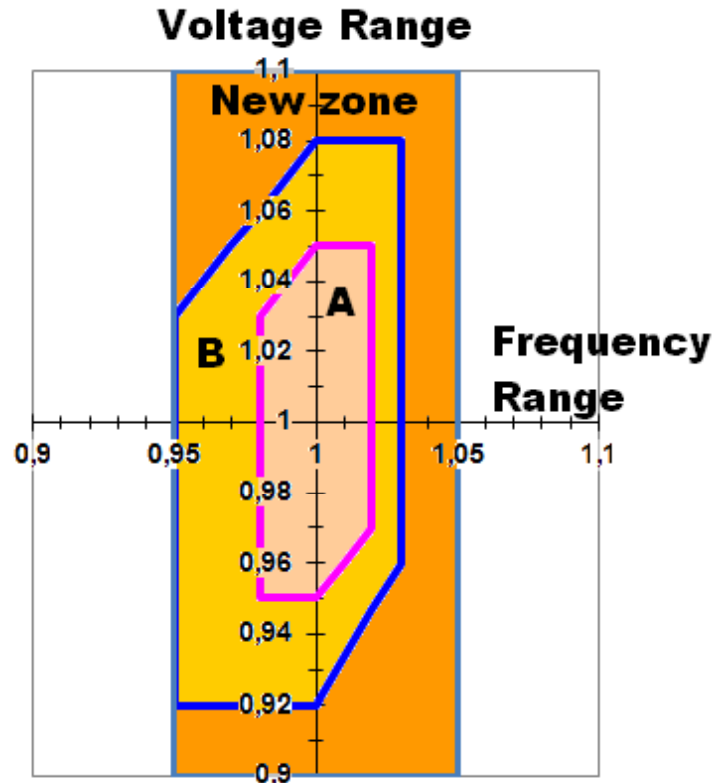

- Previously, we considered that the « Grid » was strong and maintaining the frequency within +/-5%. Operating outside of this range was considered unusual and de-rated performance was accepted (refer IEC60034)
- Now, the « Grid Code » will require operating over a wider Frequency range, usually +/-4%, possibly up to +6%
- Impact is more likely to affect the engine or turbine... so far, we do not consider that there is any impact for the alternator itself

Grid Code Impact...: Power requirement

New Grid Code imposes new operating limits...

- Regarding reactive power production and absorption
- Lagging & leading power factor requirement respectively...

Direct impact on alternator sizing... meaning:

- X_d max value criteria
- or
- K_{cc} min value criteria

Reminder: $X_d = 1/K_{cc}$

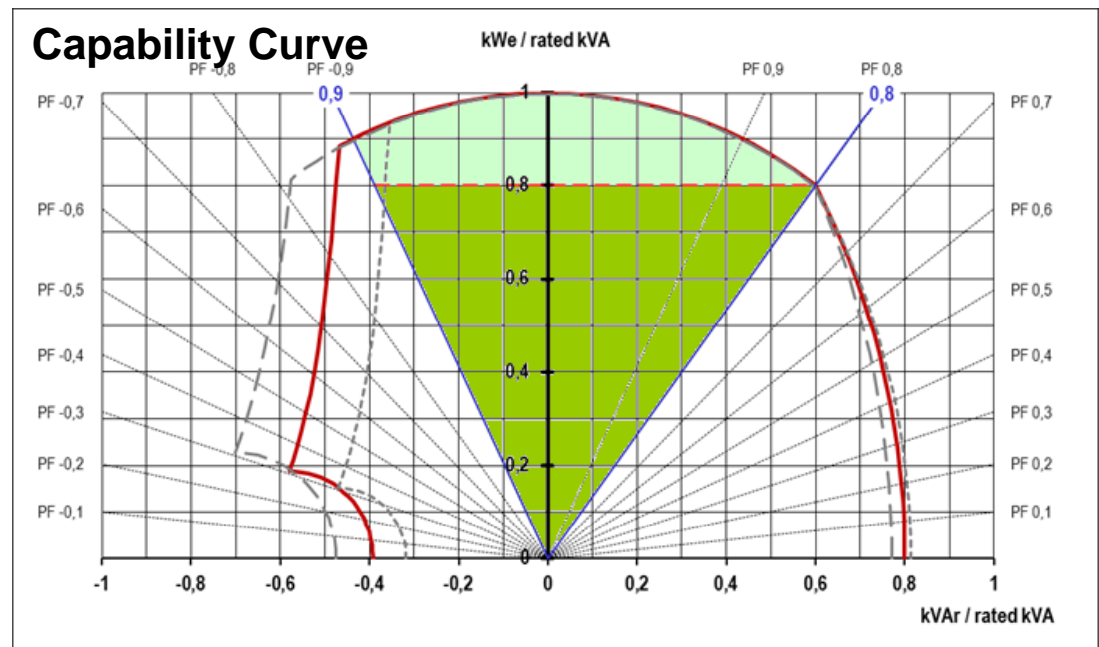

Grid Code Impact... : Power capability

- Actually, both voltage and power requirements would lead to sizing constraints...
- Voltage min & max values would possibly lead to a power derating
- Following the power factor requirement could possibly impose higher Kcc, so larger machines

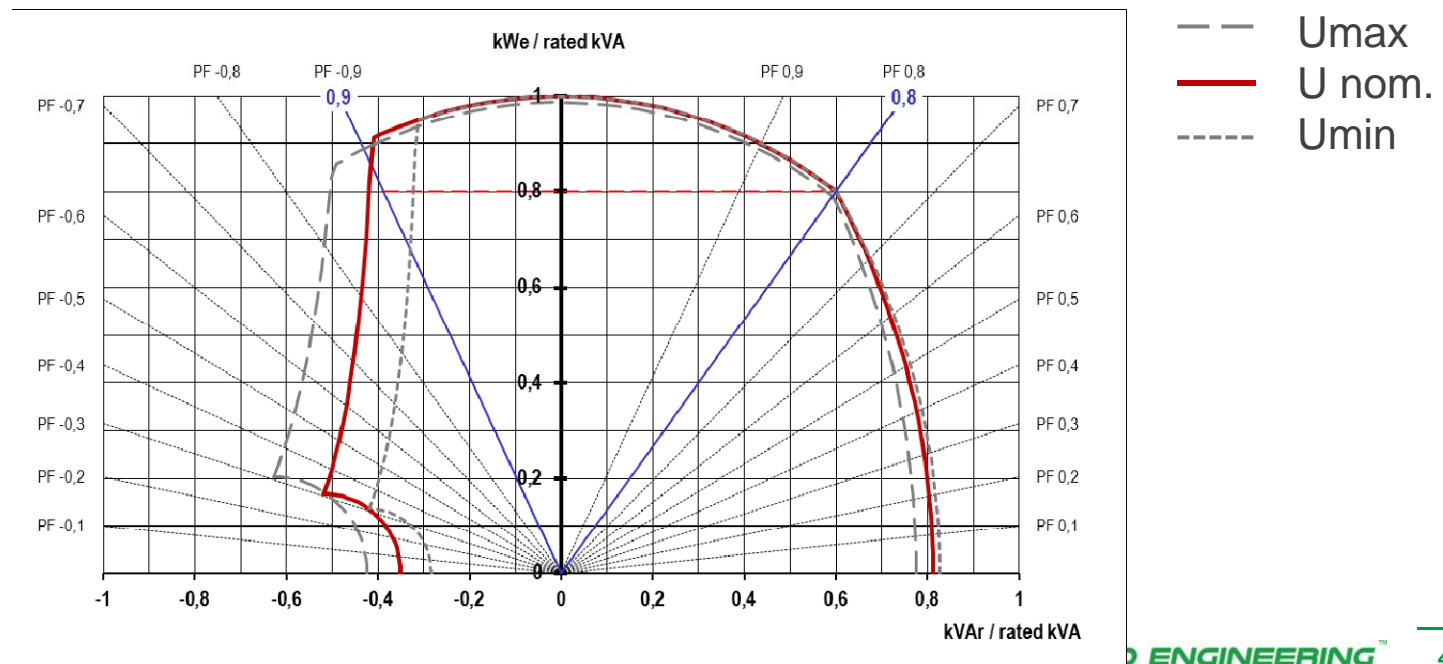

Grid Code Impact... : German grid code

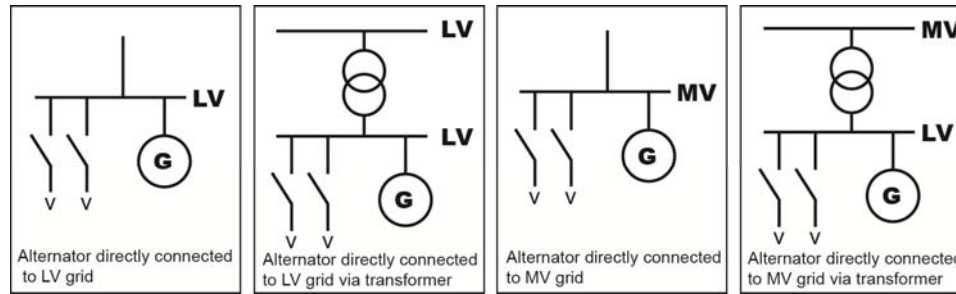

Low Voltage

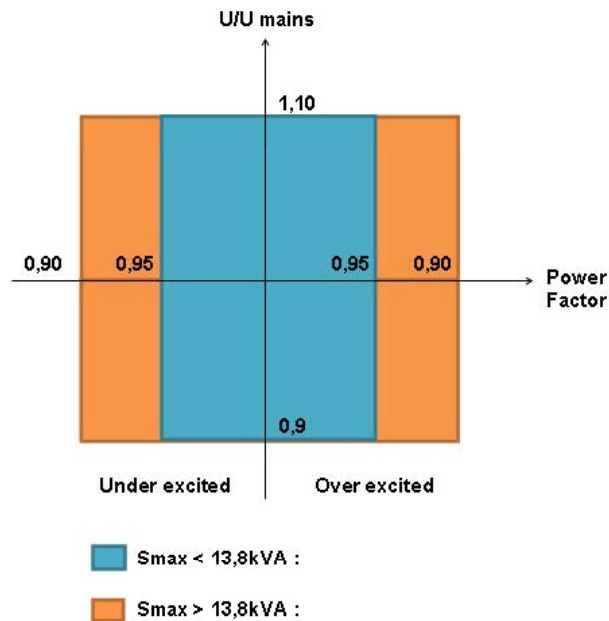

Medium Voltage

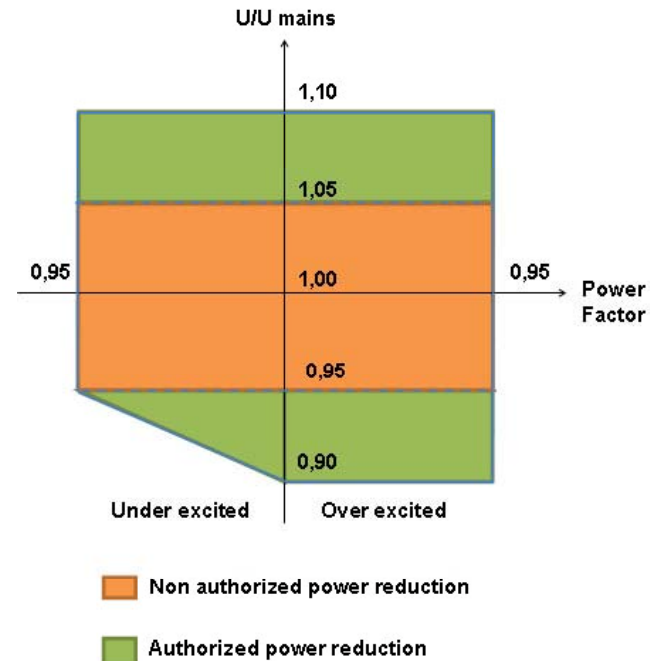

Grid Code Impact... : Dynamic

- Danger is linked to the fault appearance
- As well as the fault duration (Fault ride through)
- And the risk is when the grid comes back (Fault clearance) resulting in an unstable situation....
- **The challenge is to overcome the FRT and return safely to steady state conditions**

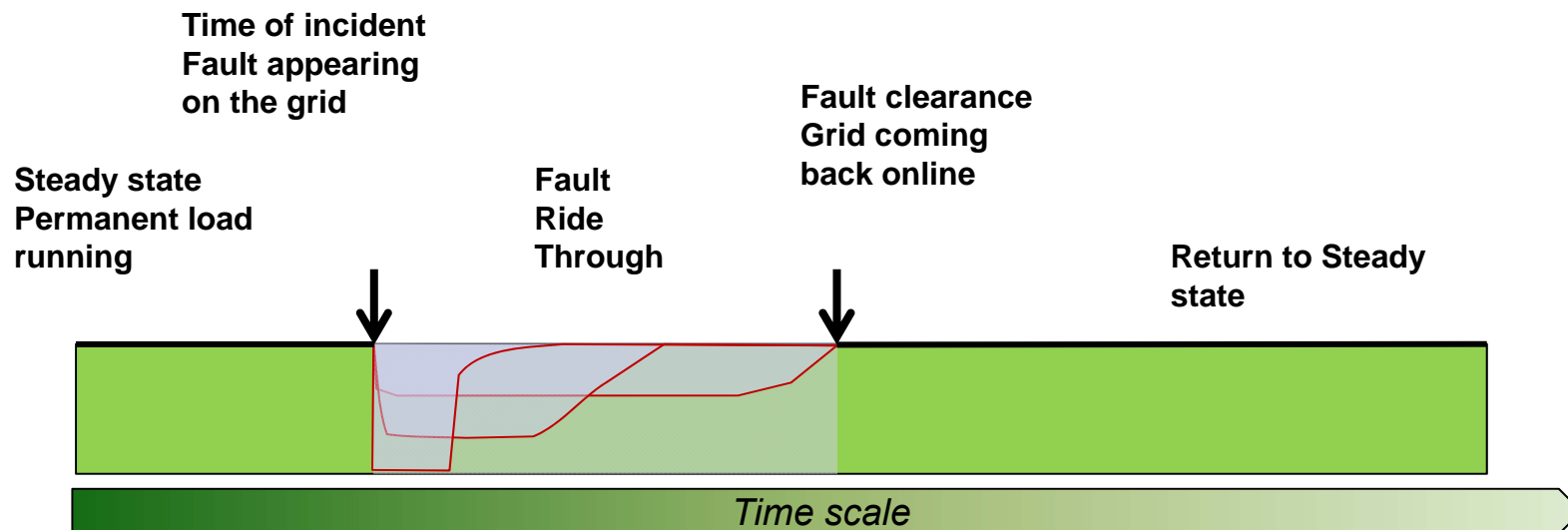

Grid Code Impact... : Dynamic FRT

- Requires to pass a “Fault Ride Through” sequence applied at the producer’s distribution point (*)
- Combining 3 severe situations:
 - Sudden short circuit
 - Loss of synchronism (ie: pole slipping)
 - Out of phase voltage re-appearance (ie: mis-synchronisation)
- Risk of damage...

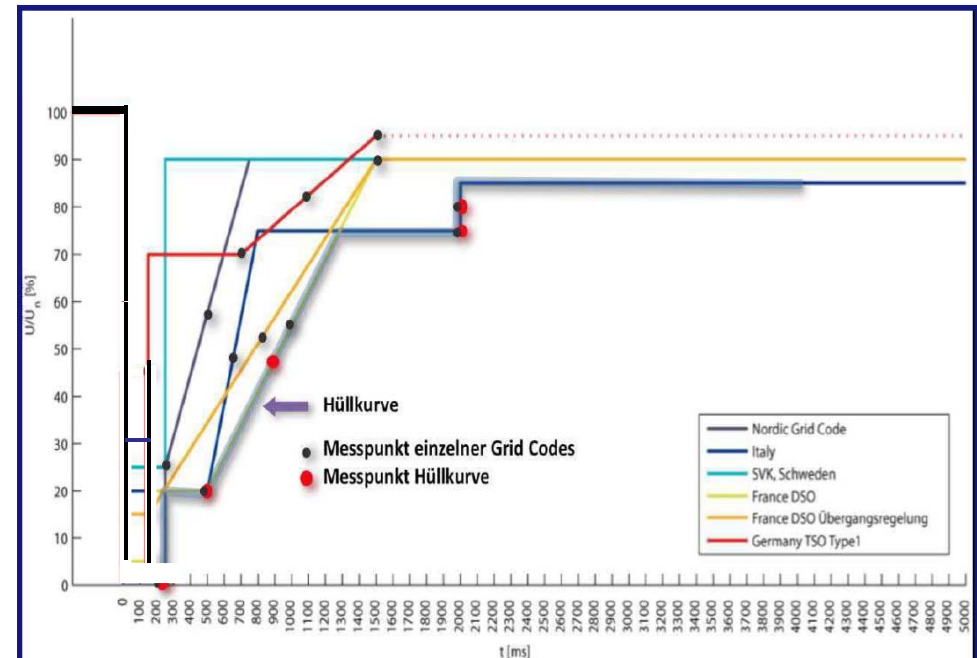

It is important to note that the fault duration is very important, but in real life extremely random !

(*) Note: the FRT is to not considered on alternator terminals but on the network

Grid Code Impact... : Stability Analysis

- A dynamic stability study has to be carried-out, by the customer (ie: power producer), to check that there is no loss of synchronism according to the site configuration, the reactance and the short circuit power capacity
- Note that the whole installation is concerned, not only the alternator itself
- LS can provide necessary data for the stability analysis (meaning main parameters & IEEE diagram, torsional, etc.)

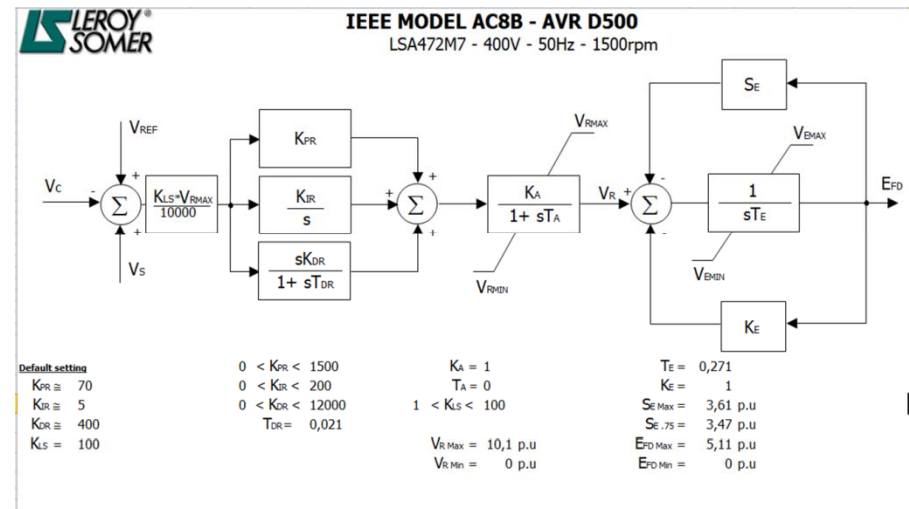

Grid Code Impact... : Short circuit

At the time of the incident, when a fault occurs on the grid, the situation is similar to a sudden short circuit, with 3 important considerations:

1. The maximum current that the alternator can provide is related to the sub transient reactance value
2. When the alternator is shorted, it provides suddenly a very high current, but usually with no voltage there is no active power delivered by the alternator to the grid. Consequently the mechanical torque produced by the prime mover is no longer converted into electrical power but is transformed into kinetic energy, leading to an acceleration of the genset.
3. Consequently, the higher the residual voltage is, the lower the speed increase will be

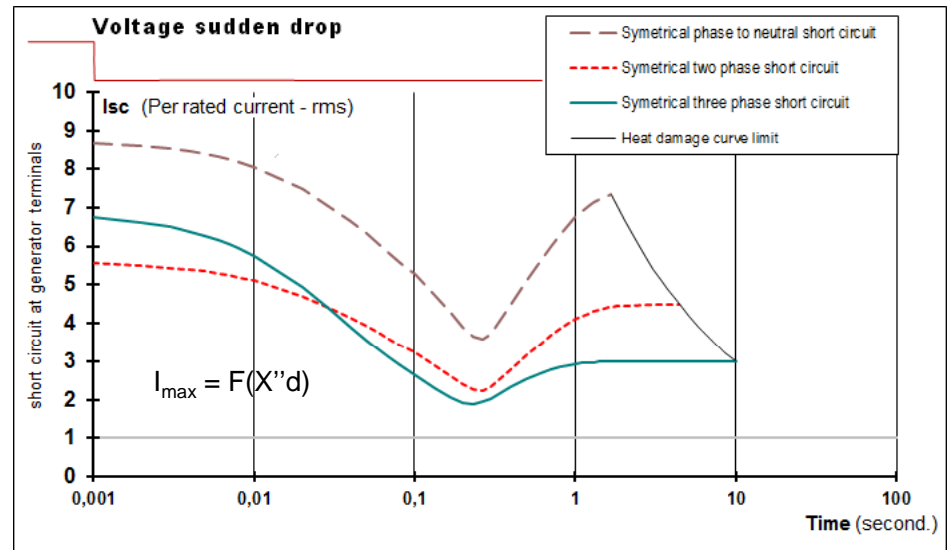
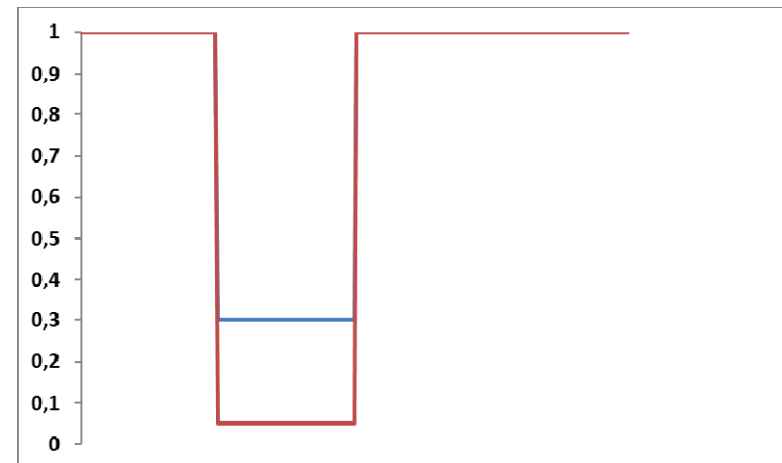

Illustration of voltage drop



Grid Code Impact... : Pole slipping

Whatever the initial situation is/was
(power factor & operating point)

- When voltage sags, engine speed will increase
- δ Internal angle will increase
- If default duration is too long, then δ will pass over critical angle
- Meaning magnetic flux is slipping from one pole to the next one
- Because of inverting magnetic flux between 2 successive poles, the pole slipping induces high current in stator winding (amplitude around $10 \times I_n$)

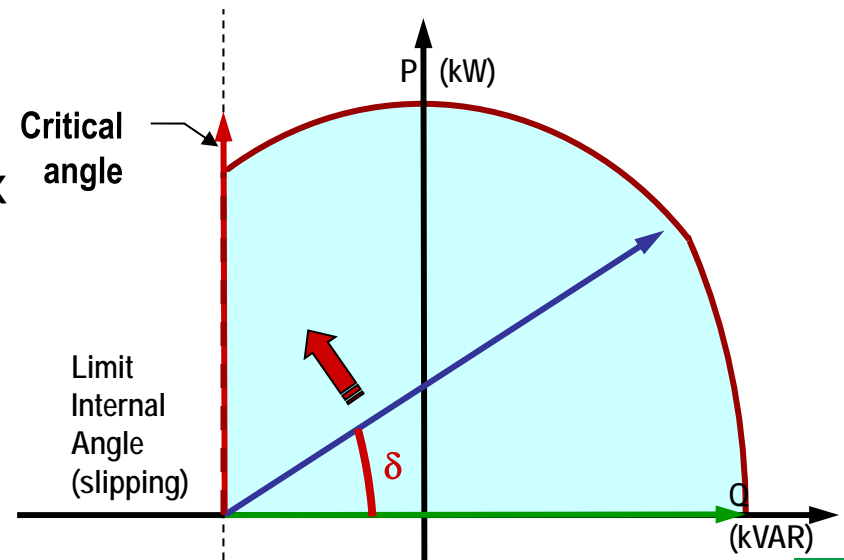
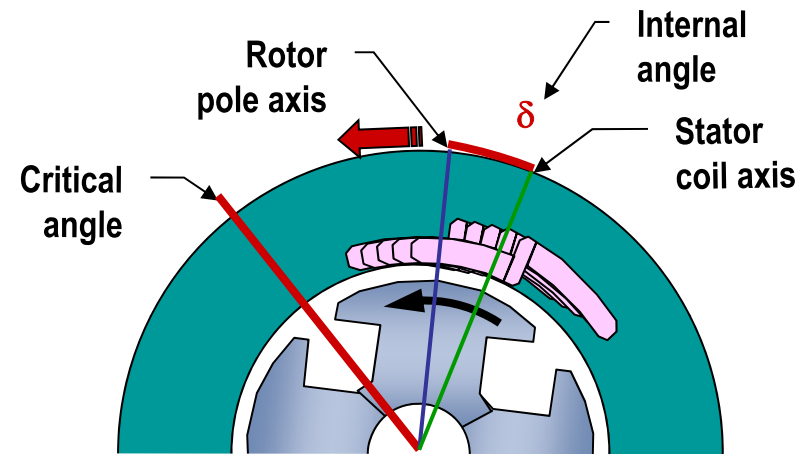

Grid Code Impact... : Voltage return

- When the fault is cleared on the grid side, then the voltage will come back !
- Depending on the real scenario, the voltage may recover initial values, but most probably, the voltage will return progressively, eventually with intermediate steps or ramps

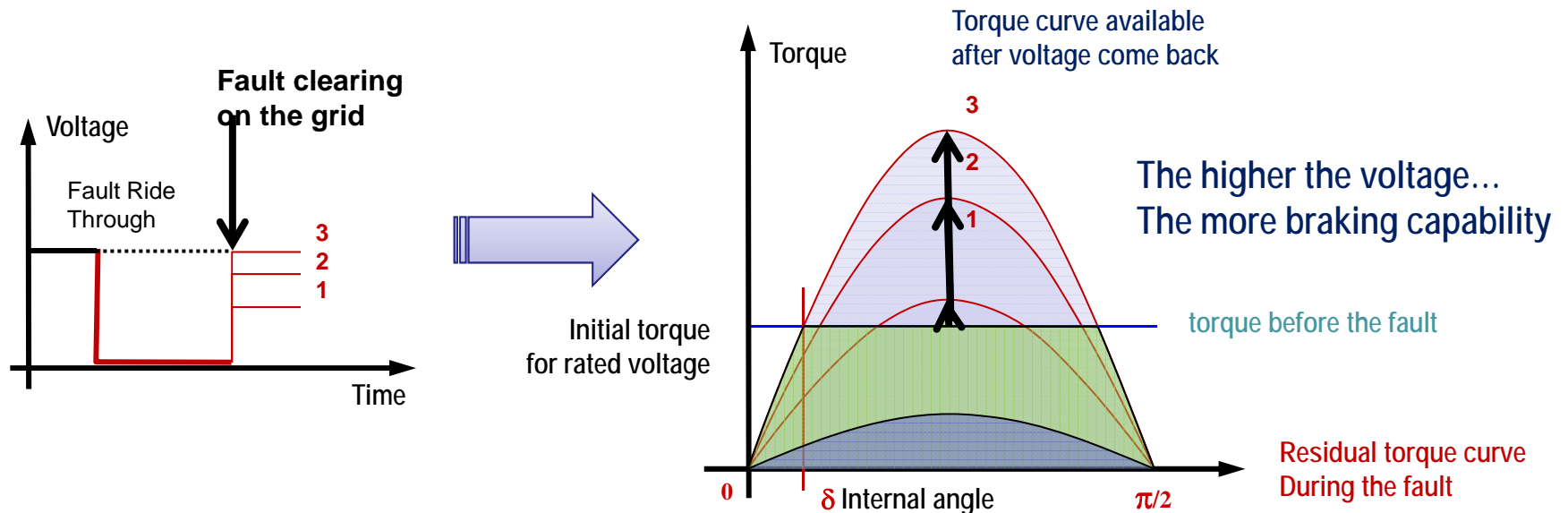

If voltage returns suddenly to nominal voltage:

- higher risk of mis-synchronising

If voltage returns progressively to nominal voltage:

- increasing risk of pole slipping

Grid Code Impact... : Synchronising

Standard synchronisation condition: in normal condition, the parameters should be as per illustration below ...

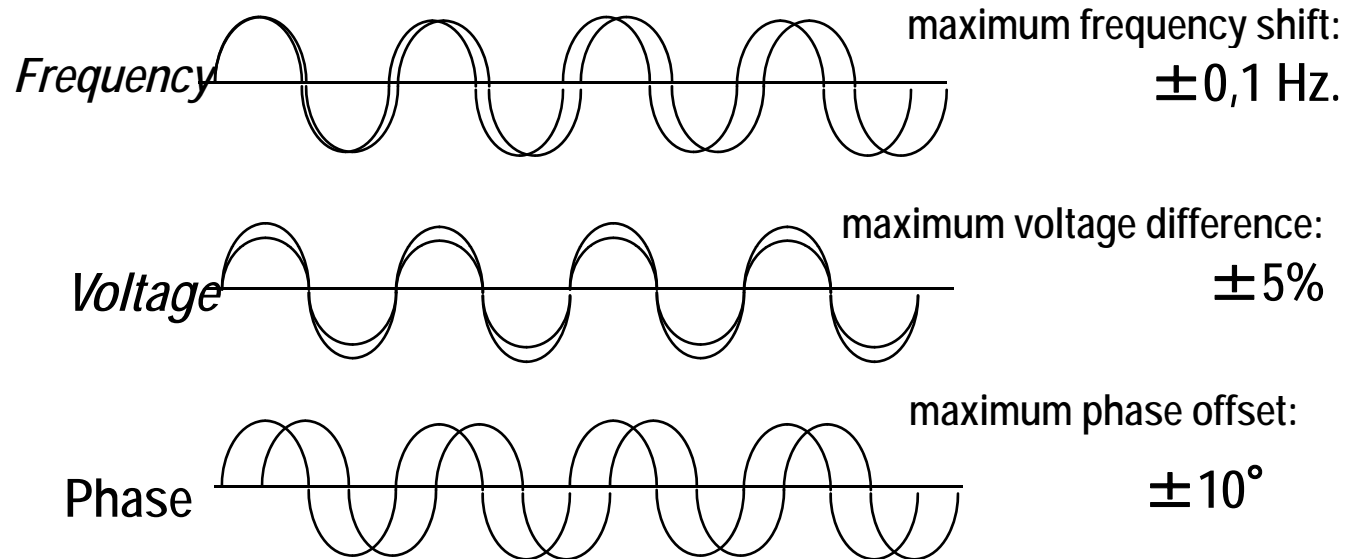

For abnormal conditions, faulty synchronization when voltage returns, phase difference +/- 30° and voltage difference +/- 10% would be acceptable.

The alternator can withstand fault synchronization as long as the stator current is less than 10 x I_n .

Grid Code Impact...: Envelope

German grid code

LS alternator in compliance with this profile

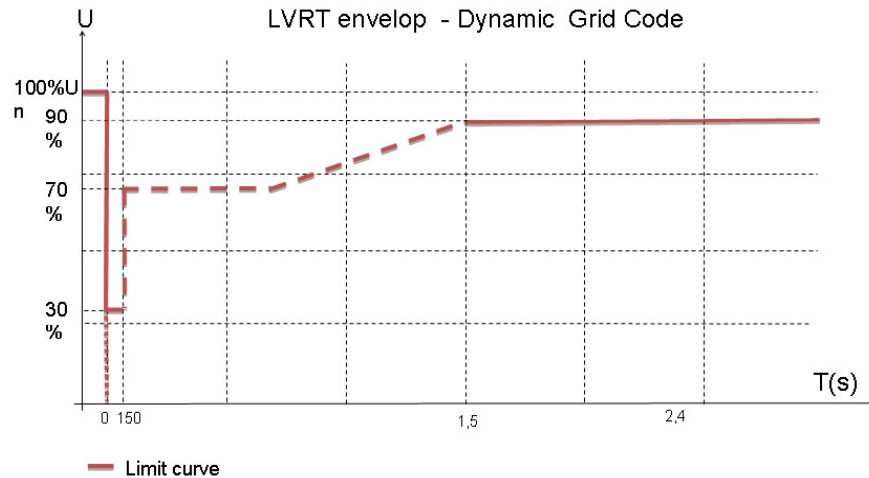

French grid code

Higher risk → more analysis to be done by the factory

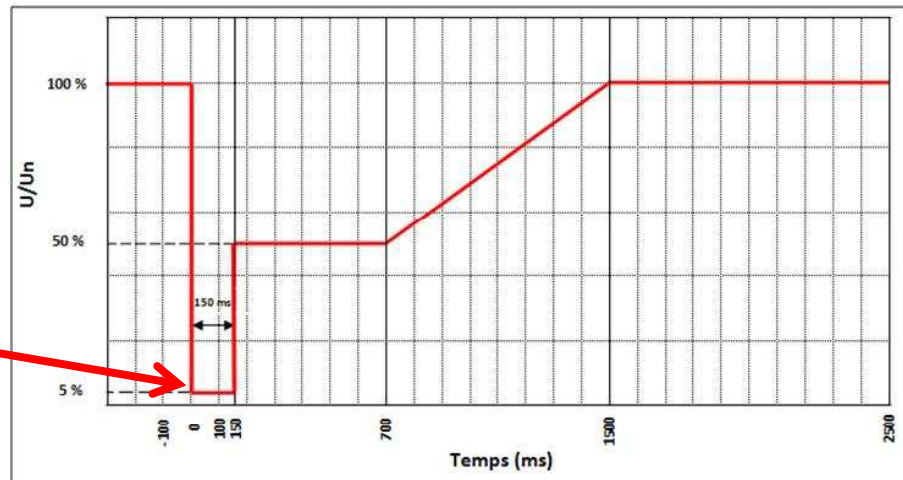

Conclusion:

In respect to Grid Code requirements LEROY-SOMER Alternators are capable to withstand:

- 20 FRT events, in accordance with local Grid Code FRT envelopes
- Considering a maximum stator current of less than $10 \times I_n$

Additional requirements:

- Digital AVR D510 or D600, enabling to switch to a voltage regulation during FRT
- Event datalogger, recording the FRT occurrence and profile

Case studies:

JENBACHER : real testing, on LSA 491 L9
AVR UNITROL

MTU : simulation and test on LSA 472 M7
AVR D510

Case study :

JENBACHER: real testing, on LSA 491 L9
MTU: simulation on LSA 472 M7

Case study: JENBACHER: real testing, on LSA 491 L9



German Grid Code

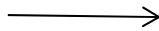

French Grid Code

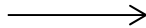

VDMa certification



1	No	Date/Time	Test Type	Test run	Initial Conditions					Load Step	Test Conditions		Power Factor	2/3 Phase Fault	
					Load	Voltage	Speed	Grid/Island/C ontainer	Power Factor		Voltage dip to				
			GRID CODE TESTS GERMANY (BDGW) + CERTIFICATION (FGW - TRG/B)	1	50%	100%	100%	Container	0,95cap	n/a	75% / 700ms	n/a	2		
				CHECK PLAUSIBILITY OF SIGNALS!!!											
				2	50%	100%	100%	Container	0,95cap	n/a	75% / 700ms	n/a	2		
				1	50%	100%	100%	Container	0,95cap	n/a	75% / 700ms	n/a	3		
				2	50%	100%	100%	Container	0,95cap	n/a	75% / 700ms	n/a	3		
				1	100%	100%	100%	Container	0,95cap	n/a	75% / 700ms	n/a	2		
				2	100%	100%	100%	Container	0,95cap	n/a	75% / 700ms	n/a	2		
				1	100%	100%	100%	Container	0,95cap	n/a	75% / 700ms	n/a	3		
				2	100%	100%	100%	Container	0,95cap	n/a	75% / 700ms	n/a	3		
				1	50%	100%	100%	Container	0,95cap	n/a	50% / 150ms	n/a	2		
				2	50%	100%	100%	Container	0,95cap	n/a	50% / 150ms	n/a	2		
				1	50%	100%	100%	Container	0,95cap	n/a	50% / 150ms	n/a	3		
				2	50%	100%	100%	Container	0,95cap	n/a	50% / 150ms	n/a	3		
				1	100%	100%	100%	Container	0,95cap	n/a	50% / 150ms	n/a	2		
				2	100%	100%	100%	Container	0,95cap	n/a	50% / 150ms	n/a	2		
				1	100%	100%	100%	Container	0,95cap	n/a	50% / 150ms	n/a	3		
				2	100%	100%	100%	Container	0,95cap	n/a	50% / 150ms	n/a	3		
				1	50%	100%	100%	Container	0,95cap	n/a	30% / 150ms	n/a	2		
				2	50%	100%	100%	Container	0,95cap	n/a	30% / 150ms	n/a	2		
				1	50%	100%	100%	Container	0,95cap	n/a	30% / 150ms	n/a	3		
				2	50%	100%	100%	Container	0,95cap	n/a	30% / 150ms	n/a	3		
				1	100%	100%	100%	Container	0,95cap	n/a	30% / 150ms	n/a	2		
				2	100%	100%	100%	Container	0,95cap	n/a	30% / 150ms	n/a	2		
				1	100%	100%	100%	Container	0,95cap	n/a	30% / 150ms	n/a	3		
				2	100%	100%	100%	Container	0,95cap	n/a	30% / 150ms	n/a	3		
				PROTECTION TESTS GERMANY	*Gesamtwirkung gskette*	1	100%	100%	100%	Container	0,95cap	n/a	30% / 300ms (protection setting at i.e. 25% 150ms)	n/a	3
				PROTECTION TESTS GERMANY	*Wiederschla tzzeit*	1	100%	100%	100%	Container	0,95cap	n/a	5% / 300ms (protection setting at i.e. 25% 150ms)	n/a	3
				GRID CODE TESTS FRANCE		1	50%	100%	100%	Container	1cap	n/a	5% / 150ms	n/a	3
						1	100%	100%	100%	Container	1cap	n/a	5% / 150ms	n/a	3
						2	100%	100%	100%	Container	1cap	n/a	5% / 150ms	n/a	3
			PROTECTION TESTS FRANCE		1	100%	100%	100%	Container	0,95cap	n/a	5% / 300ms (protection setting at i.e. 0% 150ms)	n/a	3	
					1	100%	100%	100%	Container	0,95cap	n/a	5% / 300ms (protection setting at i.e. 0% 150ms)	n/a	3	
			GRID CODE TESTS CERTIFICATION VDMA	OLSC Test	1	0%	110%	100%	Island	n/a	n/a	Sequence (See OLSC Tab)	n/a	n/a	
				AVR Step Response	1	0%	100%	100%	Open Circuit	n/a	n/a	Sequence	n/a	n/a	
					2	0%	100%	100%	Open Circuit	n/a	n/a	Sequence	n/a	n/a	
				PF Step Response	1	100%	100%	100%	Grid	n/a	n/a	Sequence	n/a	n/a	
					2	100%	100%	100%	Grid	n/a	n/a	Sequence	n/a	n/a	
				Inertia Test	1	100%	100%	100%	Grid	1	Emergency Stop	n/a	n/a	n/a	
					2	100%	100%	100%	Grid	1	Emergency Stop	n/a	n/a	n/a	
				Island short-circuit	1	50%	100%	100%	Island	1	n/1	0% / 150ms	n/a	3	
					1	100%	100%	100%	Island	1	n/1	0% / 150ms	n/a	3	
				Sudden short-circuit	1	0%	50%	100%	Island	1	n/a	0% (Short Circuit for 3s)	n/a	n/a	
				1	0%	80%	100%	Island	1	n/a	0% (Short Circuit for 3s)	n/a	n/a		
			GENSET LIMITS TESTS		1	100%	100%	100%	Container	0,8ind	n/a	5% / 250ms	n/a	3	
					1	100%	100%	100%	Container	0,95cap	n/a	5% / 250ms	n/a	3	
					1	25%	100%	100%	Container	0,8ind	n/a	0% / 100ms	n/a	3	
					1	100%	100%	100%	Container	0,8ind	n/a	0% / 100ms	n/a	3	
					1	100%	100%	100%	Container	0,95cap	n/a	0% / 100ms	n/a	3	
					1	100%	100%	100%	Container	0,95cap	n/a	0% / 150ms	n/a	3	
					1	100%	100%	100%	Container	0,95cap	n/a	0% / 250ms	n/a	3	
					1	100%	100%	100%	Container	0,95cap	n/a	0% / 300ms	n/a	3	
			2x LVRT	1	100%	100%	100%	Container	0,95cap	n/a	2x 30% / 150ms with 2000ms between faults	n/a	3		
					1	100%	100%	100%	Container	0,95cap	n/a	2x 30% / 150ms with 4000ms between faults	n/a	3	
					1	100%	100%	100%	Container	0,95cap	n/a	2x 30% / 150ms with 500ms between faults	n/a	3	
					1	100%	100%	100%	Container	0,95cap	n/a	2x 30% / 150ms with 300ms between faults	n/a	3	

Case study: JENBACHER: real testing, on LSA 491 L9

➤ German Grid code testing:

50% or 100% load, U_n
100 % speed
PF 0,95 capacitive
voltage dip =30% to 75 % of U_n
150 ms to 700 ms

➤ French Grid Code Testing:

50% or 100% load
100 % speed
PF 1
voltage dip =5% of U_n
150 ms

➤ VDMA Grid Code Testing:

100% load
100 % speed
PF 1
voltage dip =0% of U_n
150 ms
short circuit

Case study: JENBACHER: real testing, on LSA 491 L9

30% Un voltage dip
150 ms

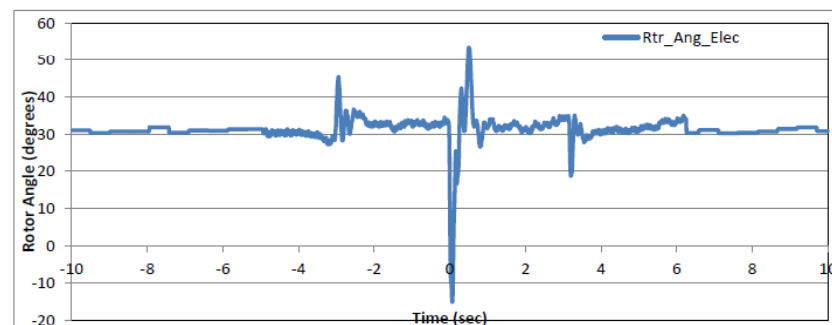
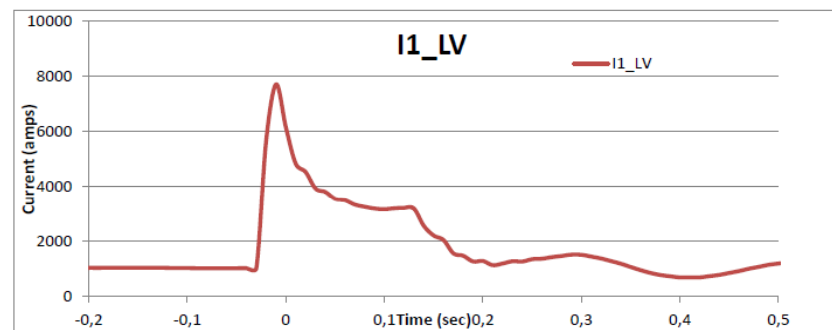
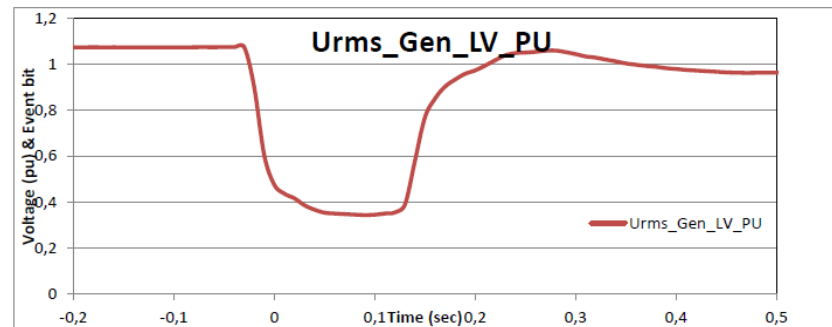

Case study: JENBACHER: real testing, on LSA 491 L9

5% Un voltage dip
150 ms

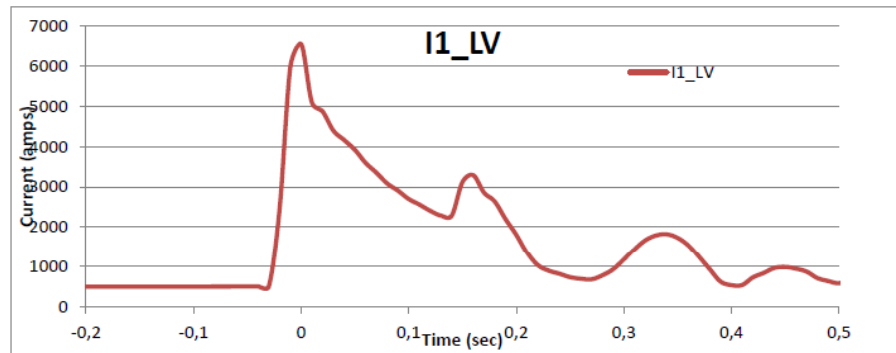
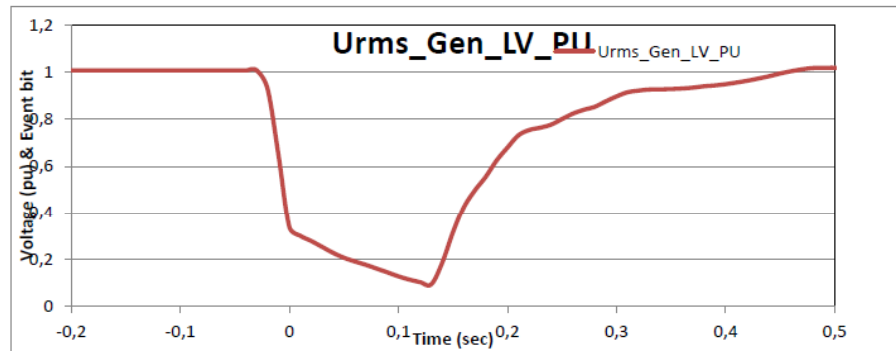

Case study: JENBACHER: real testing, on LSA 491 L9

Alternator review after LVRT tests

Introduction

This documents sums up the expertise of the LSAC491L9 C 6S/4 with serial number 278401 after Grid code Low Voltage Ride Through tests performed by GE Jenbacher. Electrical checks and visual inspections are checked and a conclusion is given from manufacturer point of view.

Alternator inspections

The alternator was dismantled and the two main parts are given as following:



Fig.1. Rotor 278401



Fig.2. Stator 278401

The insulation measurement are given as below

	Measured values at 30sec	Criteria
Exciter stator	8.20 <u>GOhms</u>	>100MOhms
Exciter rotor	75.0 <u>GOhms</u>	>100MOhms
Main Stator	6.56 <u>GOhms</u>	>100MOhms
Main rotor	22.4 <u>GOhms</u>	>100MOhms

All the measured values are higher than the minimum requirements.

Items	Status
Stator dielectric	Passed
stator resistance	OK
Stator windings	OK
Stator windings lacing	OK
Stator screws	OK
Stator windings protection	OK
Rotor dielectric	Passed
Rotating diodes	OK
Key way	OK
Rotor windings	OK
Rotor windings lacing	OK
Rotor dampers	OK
Fan	OK
Rotor screws	OK
Surge suppressor	Failed
Varnish	OK

Table.1. Inspection results

Surge suppressor is now resized

Case study:

JENBACHER: real testing, on LSA 491 L9

MTU: simulation on LSA 472 M7

Case study MTU: simulation on LSA 472 M7



IEEE MODEL AC8B - AVR D500

LSA472M7 - 400V - 50Hz - 1500rpm

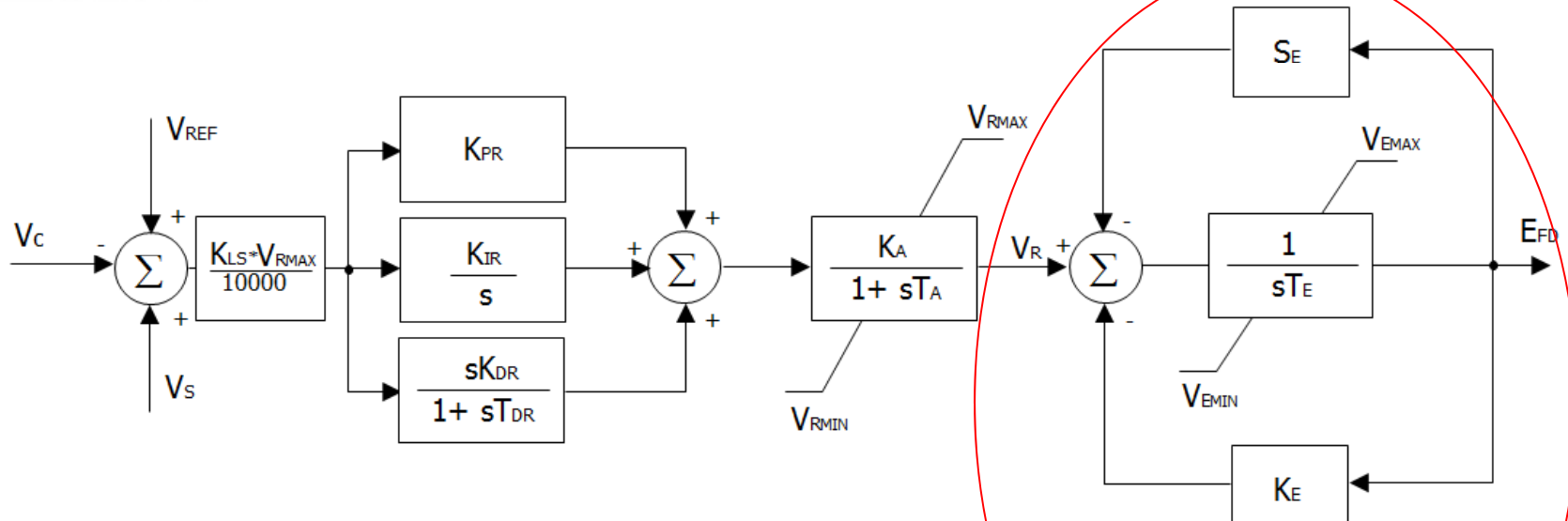

Default setting

$K_{PR} \cong 70$
 $K_{IR} \cong 5$
 $K_{DR} \cong 400$
 $K_{LS} = 100$

$0 < K_{PR} < 1500$
 $0 < K_{IR} < 200$
 $0 < K_{DR} < 12000$
 $T_{DR} = 0,021$

$K_A = 1$
 $T_A = 0$
 $1 < K_{LS} < 100$

$V_{R\ Max} = 10,1 \text{ p.u}$
 $V_{R\ Min} = 0 \text{ p.u}$

$T_E = 0,271$
 $K_E = 1$
 $S_{E\ Max} = 3,61 \text{ p.u}$
 $S_{E\ .75} = 3,47 \text{ p.u}$
 $E_{FD\ Max} = 5,11 \text{ p.u}$
 $E_{FD\ Min} = 0 \text{ p.u}$

AVR model

Exciter system

FRT study made by consultant

Most gen-sets: controller architecture

- Typical controller architecture:

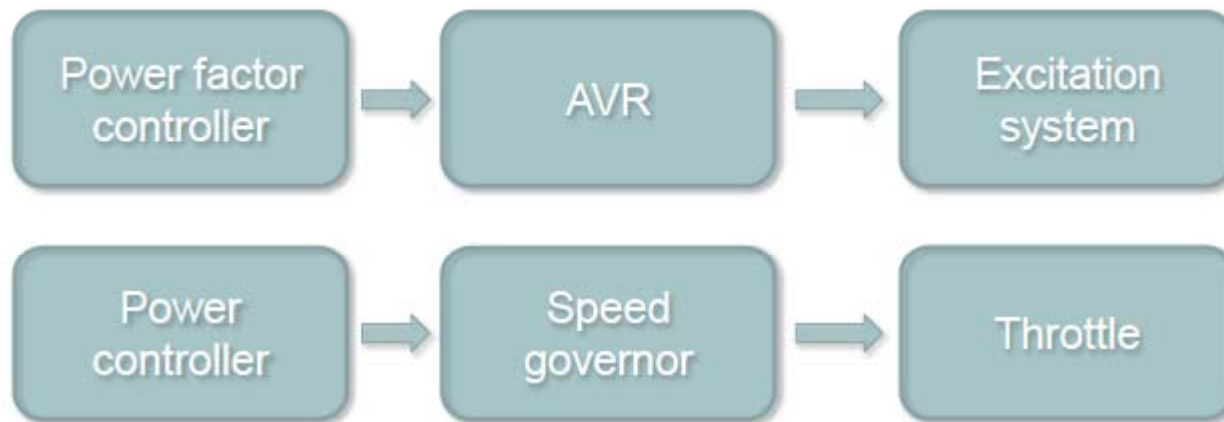

SC-L – pre-fault loading of 30%, $\cos\phi=1$

Short circuit
on load
Comparison
simulation vs
measurement

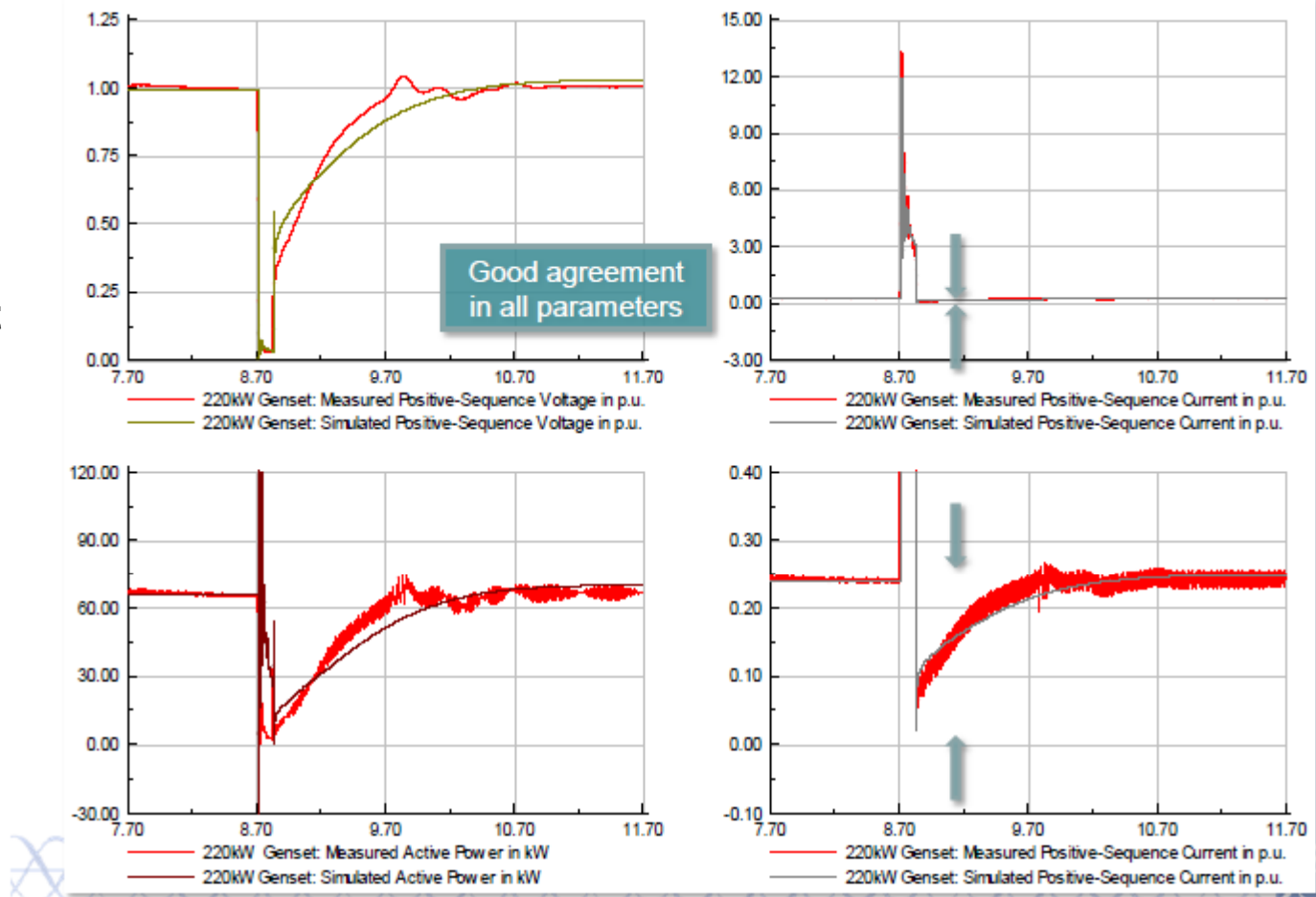

Real test on customer site in Germany:

Purpose of test:

- To check if initial simulation was coherent
- To verify the behavior of AVR D510
- To check if alternator can withstand the fault situation (open circuit, short circuit)

Case study MTU: simulation on LSA 472 M7

Scenario:

- When connected to Grid, then PF regulation is activated

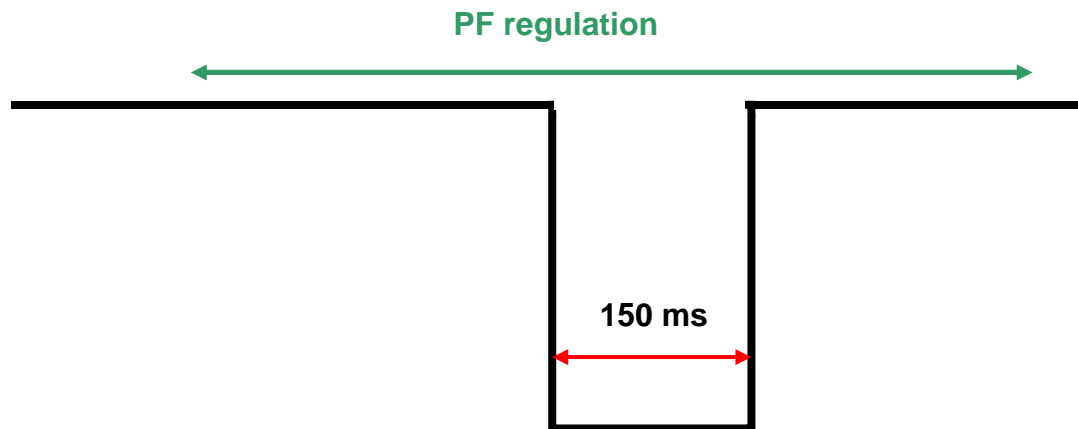

When the FRT is occurring, the AVR is switching automatically to voltage regulation mode depending on voltage drop value.

- Triggering at 90% U_n
- Time response is 10 ms

Case study MTU: simulation on LSA 472 M7

Grid code function available in EasyReg 230:

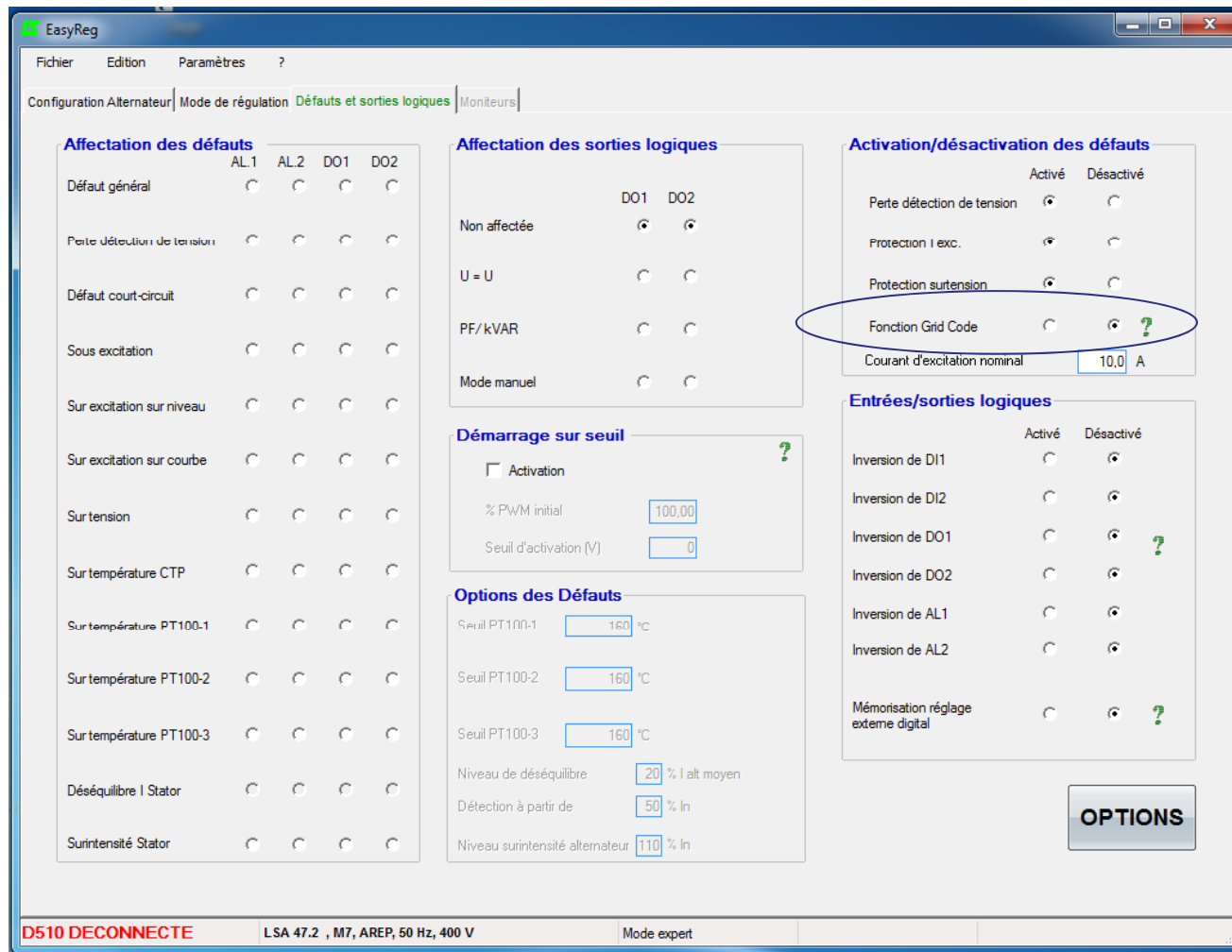

Test conclusion:

- No damage observed on alternator winding or mechanical parts
- Surge suppressor (or varistor) damaged

Test made on LSA 512 VL90 also showed no damage.

4. Power Systems

- Symmetrical components
- Per unit system

4a. Symmetrical Components

Theory of Symmetrical Components

- Phasor: a line showing the magnitude and phase angle of an AC voltage or current (*static* in steady-state)
- Phase sequence: the *order* in which peaks or zero crossings of phases occur.

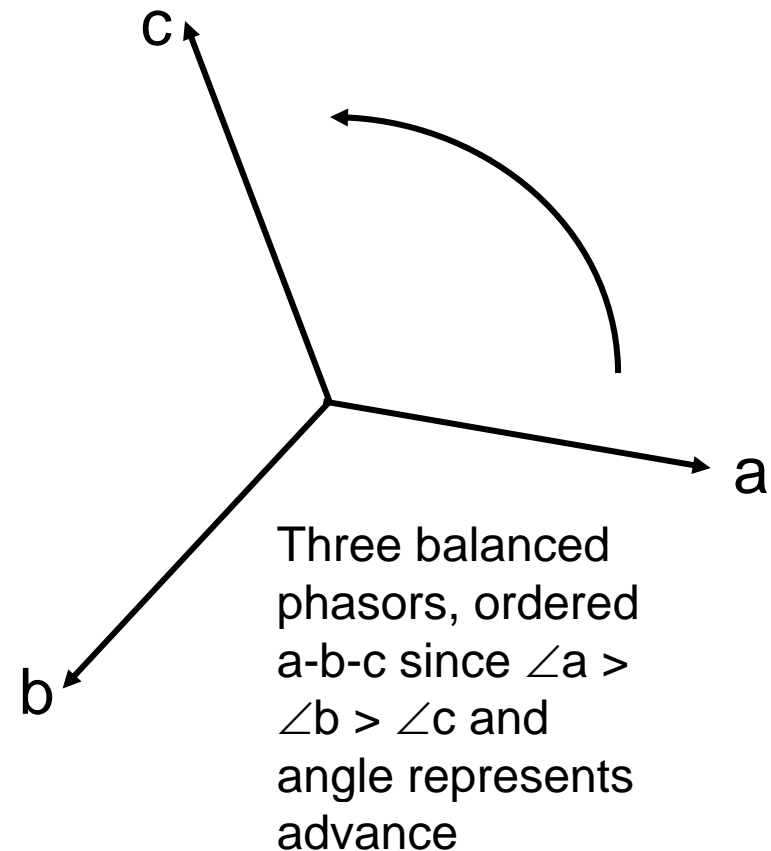

- Any unbalanced single frequency set of three phasors (three-phase system) can be decomposed into:
 - one set of three balanced phasors (all 120 degrees) with a-b-c sequence*
 - one set of three balanced phasors (all 120 degrees) with a-c-b sequence
 - one set of three balanced phasors all the same magnitude and direction.
- If you think of the phasors as rotating, they all *rotate* the same direction (the angle always increases), but their *sequence* is different

* We are assuming the *positive* sequence is a-b-c

Symmetrical Components

- The two sets of balanced phasors are the positive sequence (a-b-c) and negative sequence (a-c-b) components.
- The other set, all the same, is the zero-sequence component.

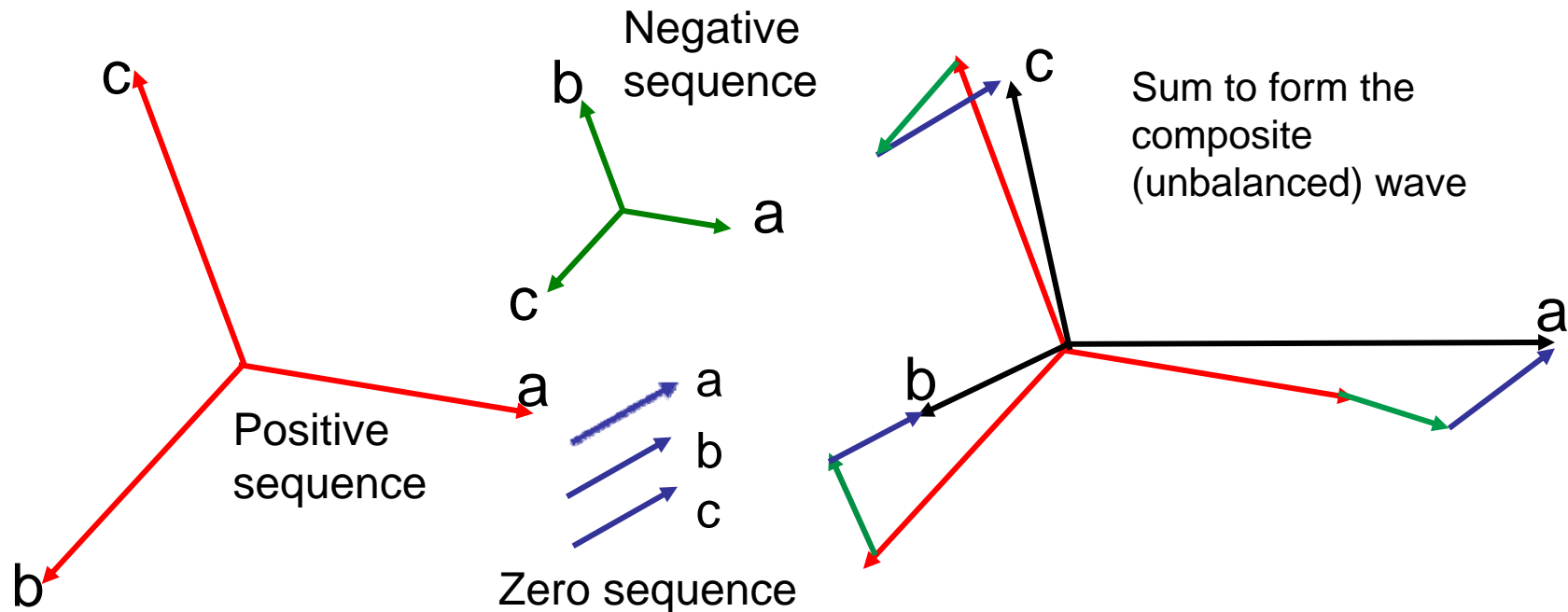

Symmetrical Components

- Uses complex notation, $\alpha = e^{\frac{2}{3}\pi i} = -0.5+0.866j$
- Multiplying by α rotates a phasor by 120°
- Multiplying a set of phasors (a complex vector):

$$\frac{1}{3} \begin{bmatrix} 1 & 1 & 1 \\ 1 & \alpha^2 & \alpha \\ 1 & \alpha & \alpha^2 \end{bmatrix} \begin{bmatrix} Va \\ Vb \\ Vc \end{bmatrix} = \begin{bmatrix} V_0 \\ V_1 \\ V_2 \end{bmatrix}$$

where V_0 , V_1 , V_2 are the zero, positive, and negative sequence components respectively (representing the “a” phase of the balanced set).

- Good articles online

Symmetrical Components

- Mathematical “trick” for analysis, but...
- Equipment (in its normal operating range) actually behaves as if these three components are present
- Negative sequence current caused by unbalanced load produces negative torque, which must be counteracted by additional positive torque
- Leads to additional losses and heating, unbalanced voltage
- Causes induced harmonic currents in rotor, which then lead to harmonics in stator (not a big problem for units with connected cage, will discuss later)

4b. Per-Unit System

Per-Unit System

- Per unit system was developed to aid in the comparison of machines of systems with different ratings
- All values expressed as a fraction of percentage of machine rating or “base value”
- Impedances expressed as fraction of “base impedance:”

$$Z_{\text{B}} = \frac{V_{\text{L-N}}}{I_{\text{L}}} \quad (\text{for a wye connected machine})$$

- Helps form a better mental impression of quantities than would be possible expressing them in physical units
- Gets rid of all the conversion constants

5. Reference Frame Theory: Generator Models and Park's Equations

Intro to Reference Frame Theory

Short Version

- Three phase balanced set of AC currents creates approximately a moving wave of sinusoidal flux which travels around the stator at a rate determined by the frequency
- In a synchronous machine, the rotor rotates at the same (average) speed as this flux wave

Intro to Reference Frame Theory

Short Version

Imagine you are on a new theme park ride (“The Synchronous Generator! Amazing!”)

- You take your seat on the rotor of the generator and put on your magic 3D glasses which allow you to see the magnetic lines of force, and the currents
- The machine starts and comes up to 1800 RPM...*

*Only 1500 in Europe, which is why EuroDisney is boring

Intro to Reference Frame Theory

Short Version

When excitation is applied to the generator with no load you see lines of flux going straight up from the rotor to the stator.

- They are most concentrated at the center of the rotor
- There are few between the poles
- On the adjacent poles they go from the stator to the rotor
- There is no current in the stator

Intro to Reference Frame Theory

Short Version

- If a lagging zero-power-factor load* is applied.
 - You see stator current ahead of you, going to the right, and behind you going to the left, but none near the center of the pole
 - The location of the current is steady from your point of view, even though the surface of the stator is passing by at high speed
 - The lines of flux are reduced, because the stator current is in the opposite direction from the rotor current
- * Lagging power factor means that the peak of the current occurs after the peak of the voltage. Leading power factor means the peak of the current occurs before the peak of the voltage. For resistive load, the peak of the current and voltage occur at the same time.

Intro to Reference Frame Theory

Short Version

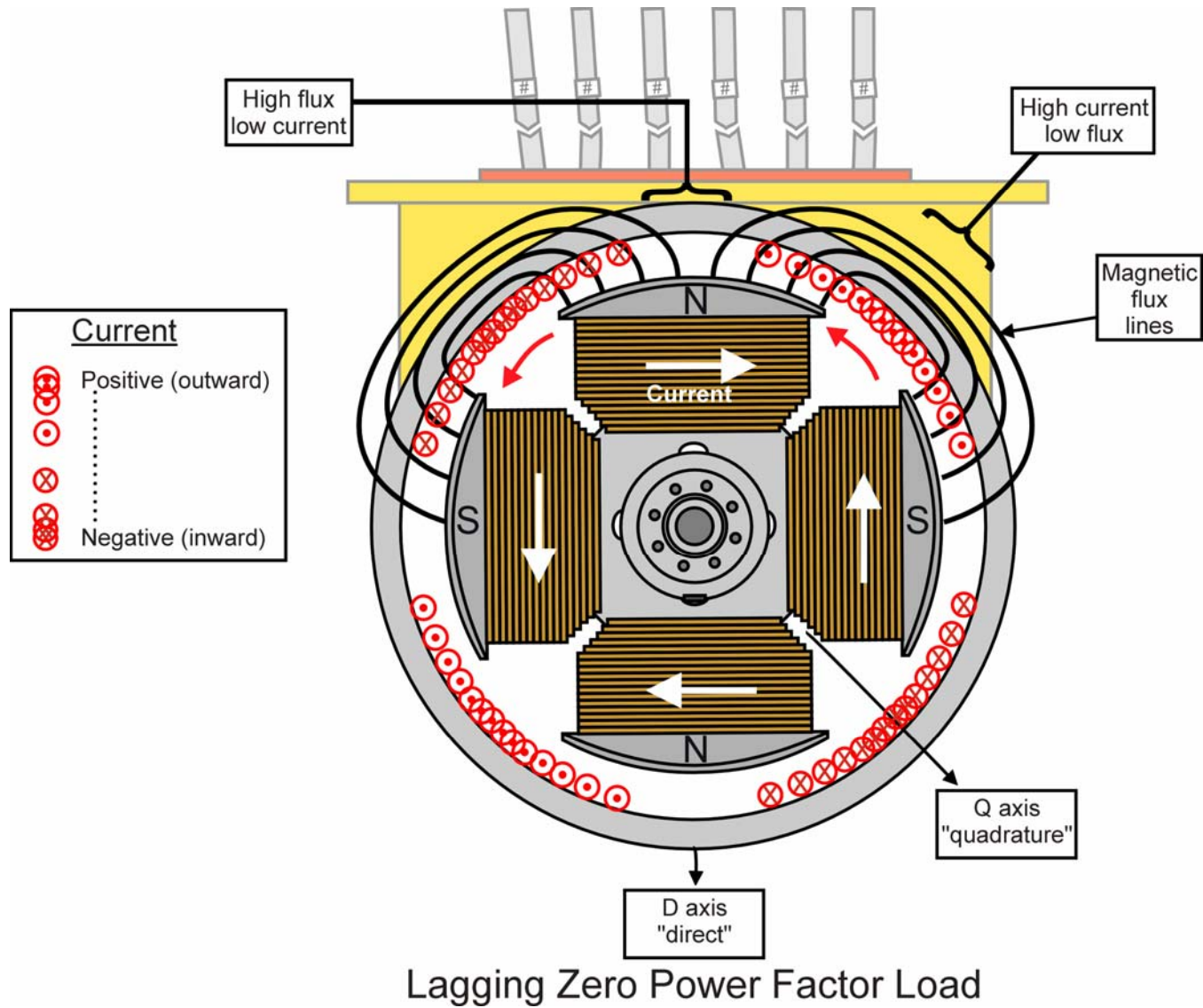

Intro to Reference Frame Theory

Short Version

- If a leading zero power factor load is applied:
 - You see stator current ahead of you, going to the *left*, and behind you going to the *right*, but none near the center of the pole
 - The location of the current is still steady from your point of view
 - The stator current flows the opposite direction, and the flux is strengthened
- In both cases, there is high flux where the current is low, and vice versa, so no torque is developed

Intro to Reference Frame Theory

Short Version

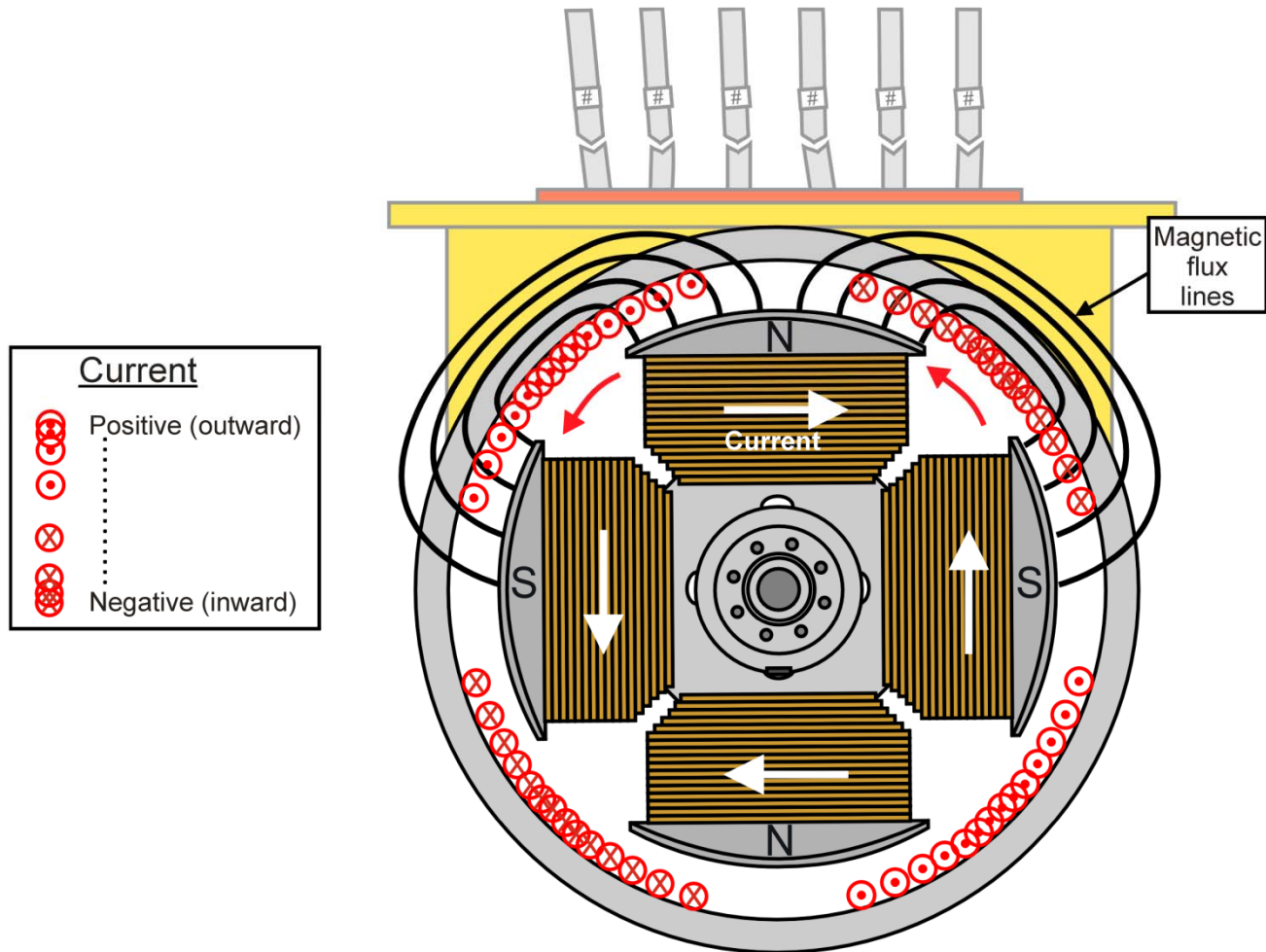

Leading Zero Power Factor Load

Intro to Reference Frame Theory

Short Version

- If a real (unity power factor) load is applied:
 - You see current from left to right over the center of the pole head -- where there is high flux -- and low current between the poles. Current x flux generates force (power).
 - The current in the stator pulls the lines of flux backward, crowding them into the trailing edge of the pole head
 - Unity power factor load does not have a big effect on the total flux

Intro to Reference Frame Theory

Short Version

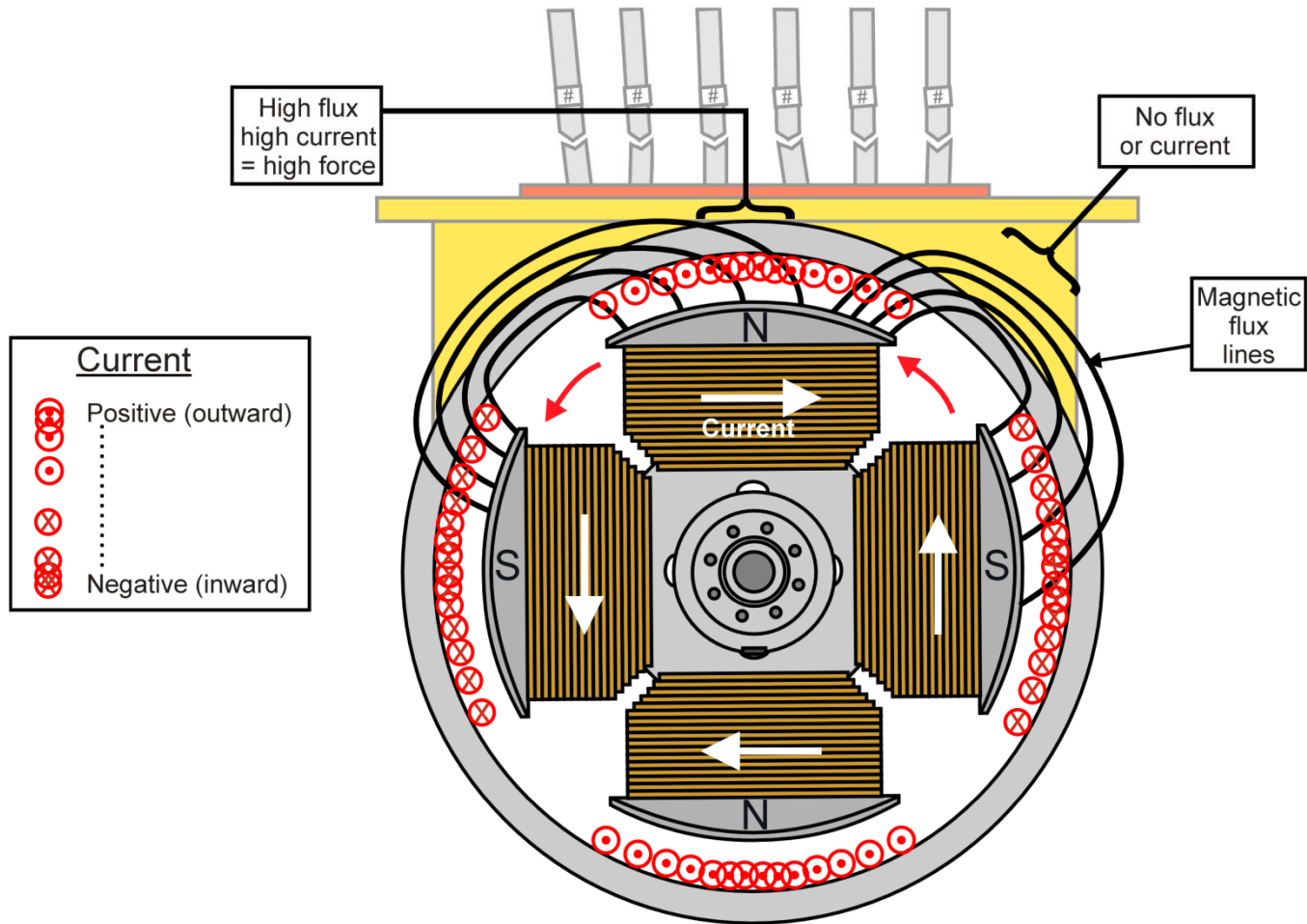

Unity Power Factor Load

Intro to Reference Frame Theory

Short Version

- Summary of generator loading:
 - Lagging power factor (inductive) current demagnetizes the rotor, requiring higher field current to compensate. It does not produce any torque or power.
 - Leading power factor (capacitive) current aids the magnetization of the rotor. So less field current is required. It does not produce any torque or power.
 - Unity power factor (resistive) current neither magnetizes nor demagnetizes the rotor, so field current is not affected (much). A retarding torque is produced which consumes mechanical power and produces electrical power.
 - Above is an oversimplification, due to internal losses and reactances

Intro to Reference Frame Theory

Short Version

Use the Clarke transform to convert to direct/quadrature axes:

The Clarke transform (named after [Edith Clarke](#)) converts vectors in the ABC reference frame to the XYZ (often $\alpha\beta z$) reference frame. The primary value of the Clarke transform is isolating that part of the ABC-referenced vector which is common to all three components of the vector; it isolates the common-mode component (i.e., the Z component). The power-invariant, right-handed, uniformly-scaled Clarke transformation matrix is [from Wikipedia]

$$K_C = \sqrt{\frac{2}{3}} \cdot \begin{bmatrix} 1 & -\frac{1}{2} & -\frac{1}{2} \\ 0 & \frac{\sqrt{3}}{2} & -\frac{\sqrt{3}}{2} \\ \frac{1}{\sqrt{2}} & \frac{1}{\sqrt{2}} & \frac{1}{\sqrt{2}} \end{bmatrix} \cdot \text{So } u_{abc} \text{ (rotating) becomes } u_{xyz} \text{ (stationary).}$$

The non-power-invariant form is more common in older texts, it just removes the square root sign, and preserves voltages or currents instead of power. Note the quantities are amplitudes, not RMS values, in fundamental system (dimensionless in per-unit system).

This is a similar process with *vectors* to what we do with *phasors* in symmetrical components. Or is it the other way round? Anyway...

Intro to Reference Frame Theory

Short Version

Then we change all stator quantities to rotor reference frame (stop the rotation).

This is the Park transformation. It multiplies the instantaneous vector quantities by reference vectors rotating (normally) at the same speed as the rotating MMF from the field winding:

$$K_P = \begin{bmatrix} \cos(\theta) & \sin(\theta) & 0 \\ -\sin(\theta) & \cos(\theta) & 0 \\ 0 & 0 & 1 \end{bmatrix}. \text{ So } u_{xyz} \text{ (3-phase) becomes } u_{dqz} \text{ (2-phase plus zero).}$$

When $\theta = \omega t$, the reference frame is rotating at ω radians/sec. If this is the rotor speed, the new reference frame is stationary with respect to the rotor, and all steady-state stator quantities become DC.

This is similar to the way traditional DC motors actually work: the field is stationary, and the commutator effectively performs a transform on the rotating armature currents so that they become stationary as well.

There are a lot of good articles online for further reading (including Park's original 1926 article).

6. Excitation System Models and Exciter Response

Exciter AC8x Model

- The models of excitation systems defined in IEEE Std 421.5 (most recent 2016) are appropriate to different kinds of exciters and regulators. The AC8x model is becoming popular for PID regulators used with synchronous brushless exciters such as are normally used on Kato generators. It represents the exciter adequately for system modeling purposes.
- The definition of exciter constants in the Standard is left to the manufacturer of the exciter. Unfortunately, no guidance is given for how to calculate those constants. Correspondence with the Working Group for this standard has yielded no further clues, so we are apparently on our own as regards the interpretation of the standard.

- We make the following assumptions:
 - 1.0 PU input (loaded, steady-state) gives 1.0 PU output by the usual generator convention
 - Having said that, we frequently use “no-load, rated output” as the generator per-unit base as it is simpler to find out
 - Since our exciter program does not calculate or use the rectifier “regulation curve” (Fig. D-1 in the 2016 standard) there is no way to match it with our calculated exciter performance, so K_c will be set to zero and this effect ignored. Partial justification: when the rectifier is operating in Mode I, this regulation can be lumped in with K_d . When it is in Mode II or Mode III the exciter is practically a current source anyway, so the exciter X_d is dominant and rectifier regulation is a secondary effect (needs to be verified per case).

- Assumptions:
 - K_d in the AC models appears as a linear term, whereas in the actual exciter it produces a curve depending on the effective field impedance and the effective displacement power factor of the rectifier (which are variable in the transient condition). We assume if we match the exciter performance when it is unloaded and fully-loaded the errors in-between won't matter much.

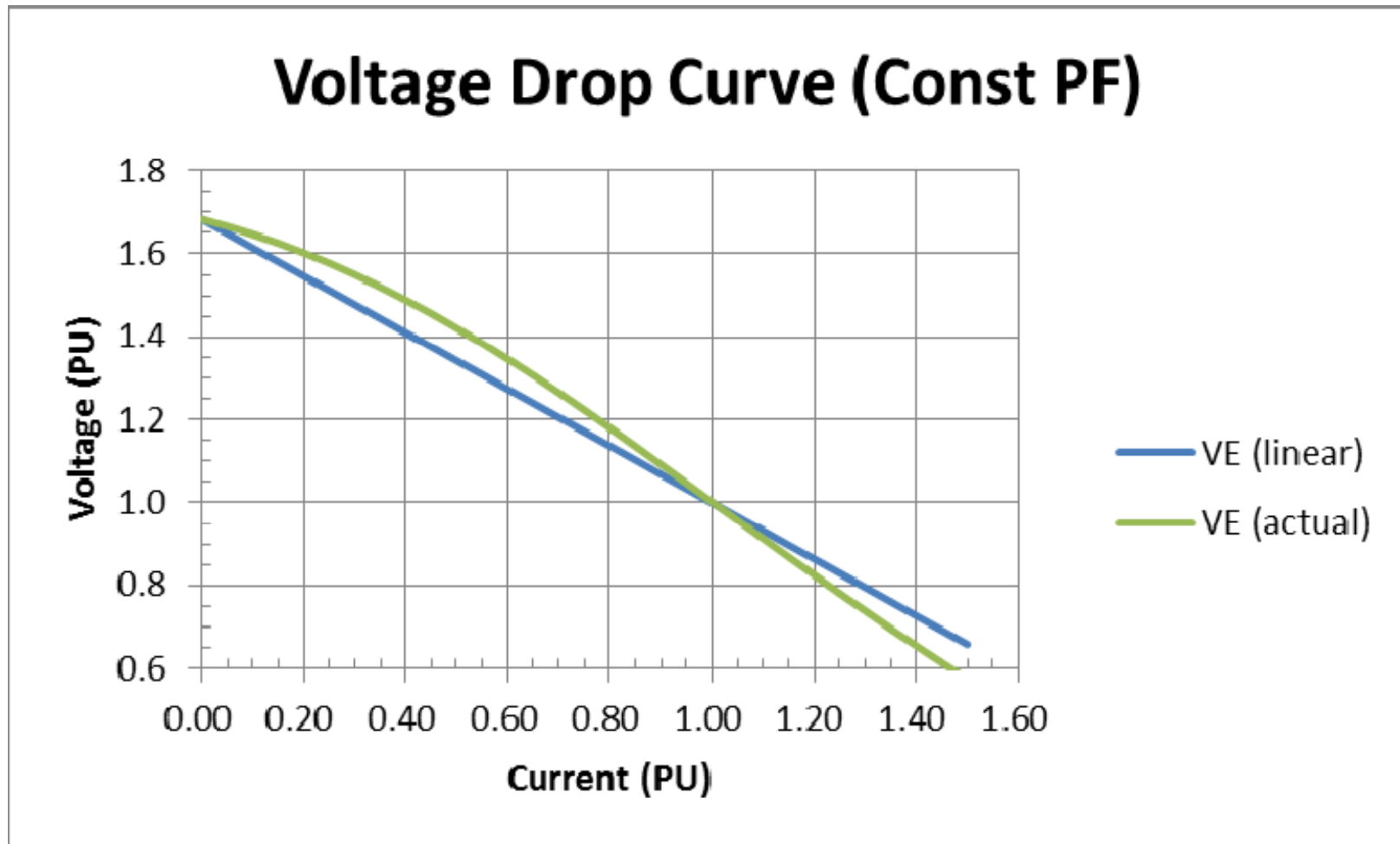

Exciter AC8x Model

- Assumptions:
 - Kato exciters normally have minimal saturation at normal operating conditions, so the Kd value will be calculated without considering saturation. This will avoid an iterative process
 - For the calculations below, we assume that 1.0 PU regulator output is 1.0 PU exciter field input. If this is not the case (because of a fixed regulator model e.g.) then Ke can be adjusted to compensate.
 - We believe that normally the exciter constants should be calculated *hot* as this is the usual operating condition

Exciter AC8x Model

- Calculations: From the exciter saturation curves, determine the exciter field current values for:
 - 1.0 PU output loaded. This will be the per-unit base for exciter output.
 - With 1.0 PU input from (a), 1.0 PU output on *air gap line* = E_{ocu} , and on unloaded saturation curve = E_{oc} . If they differ by more than (say) 3%, then the exciter is saturated at normal operating conditions and K_d and K_e calculations will have to consider saturation.
 - Ceiling voltage unloaded (in case the regulator is not known, use the standard values)
 - From the unloaded ceiling voltage, determine $Se(\max)$ *unloaded*
 - From 75% of the unloaded ceiling, determine $Se(0.75 \max)$

- Calculations:
 - Eocu is the *unsaturated* open-circuit exciter/rectifier output with 1.0 PU input. This will be greater than 1.0. If Kc were included, it would also modify this term. We ignore saturation for the reasons explained above.
 - $K_e = 1/E_{ocu}$. $E_{FE}/(K_e+K_d)$ should give 1 PU output if E_{FE} is 1 PU input, so $K_e+K_d = 1$ so $K_d = 1-K_e$. Unlike the AC5A model, K_e will not normally be equal to 1, if my assumptions are correct.
 - T_E will be the exciter value of T'do during transients when the exciter output is zero, but will be somewhat lower otherwise. For conservative estimation of recovery time etc., we recommend using T'do for transient response calculations.

Exciter Response Ratio

- A measure of how much output is available from the exciter after half a second under forcing conditions, compared to its normal output.
- Based on 1959 AIEE article by V.C. Strode. Now embodied in IEEE Std 421.2-2014.
- Meant as a metric for comparison of excitation systems
- 0.5 second is a long time for a modern excitation system, except maybe for power-plant size machines
- Can't really be calculated without a full magnetic model of generator and exciter, including rotating rectifier
- Some useful approximations can be made

Exciter Response Ratio

1. We assume that the exciter is not highly saturated. This is a good approximation for most Kato exciters, and is conservative if the exciter is saturated.
2. We assume that the generator field is purely resistive. This is definitely not the case, but is the way the exciter is tested on its own, and the actual field inductance will result in higher response ratio, so it is conservative.
3. Absent any better value, we use the exciter $T'do$ as the exciter time constant. The loaded time constant will be shorter so the response will be faster. This is also conservative.

Exciter Response Ratio

- Procedure: operate the exciter (usually with resistive load) at its nominal full-load point, then suddenly increase the exciter field voltage to the regulator ceiling value
- Take a recording of the exciter output voltage under these conditions, for at least half a second
- Draw a straight line from the initial point such that the area under the line, between time = 0 and time = 0.5 second, is the same as the area under the exciter response curve (in the past this was generally an “eyeball” estimation). The value of voltage at the end point of the line, divided by the full-load starting voltage, less one, times 2, is the response ratio (second⁻¹).

Exciter Response Ratio

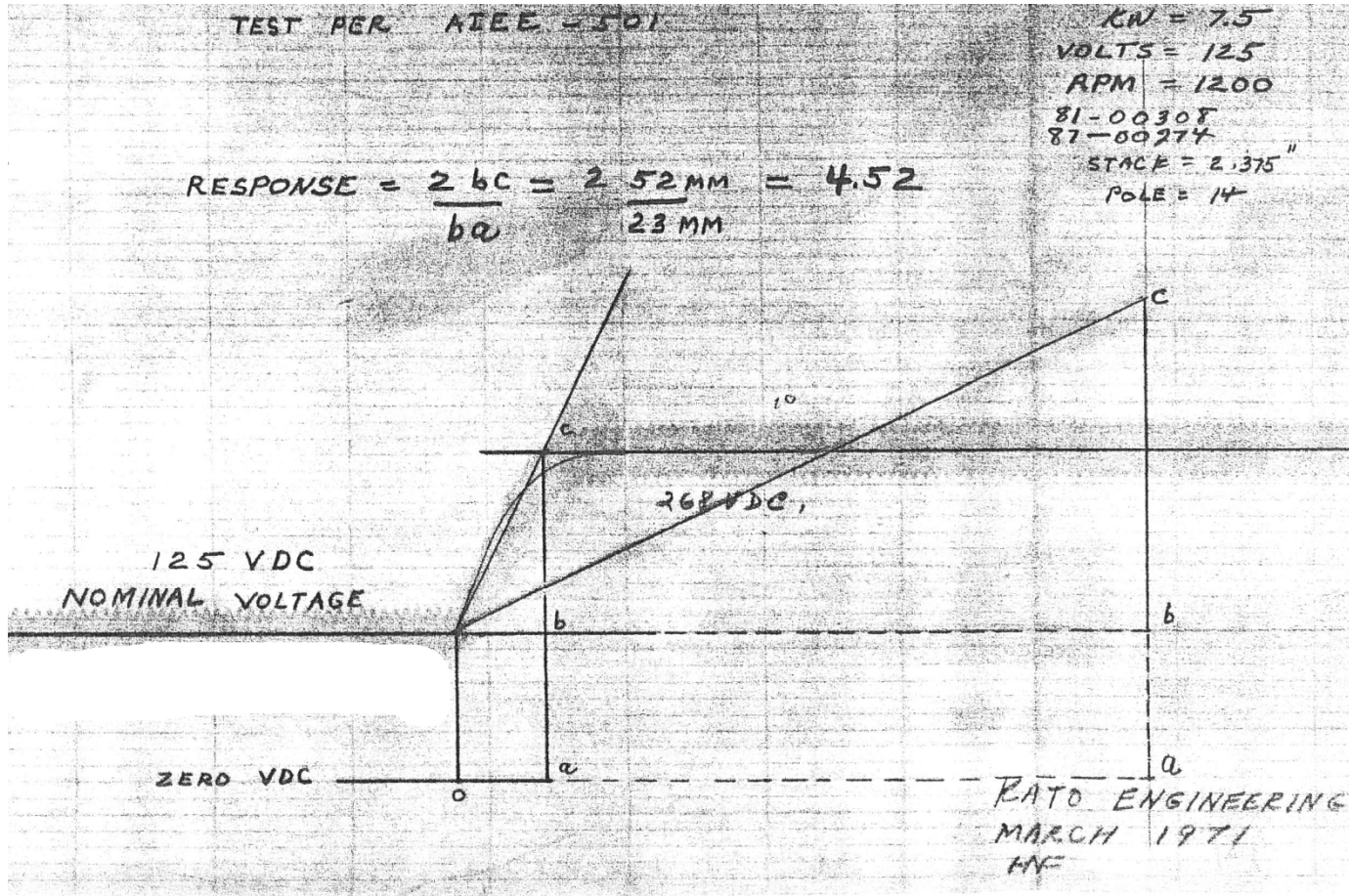

Typical Response Ratio Test

Exciter Response Ratio

- Nowadays we would do a numerical integration based on data acquisition output to determine the test result
- Normally we do not perform this test (it requires slip rings and is expensive). We can get a good approximation of the result by calculation based on exciter data sheet. A spreadsheet can be used to perform this calculation.
- Alternatively, a nomograph is available to calculate response ratio

Exciter Response Ratio

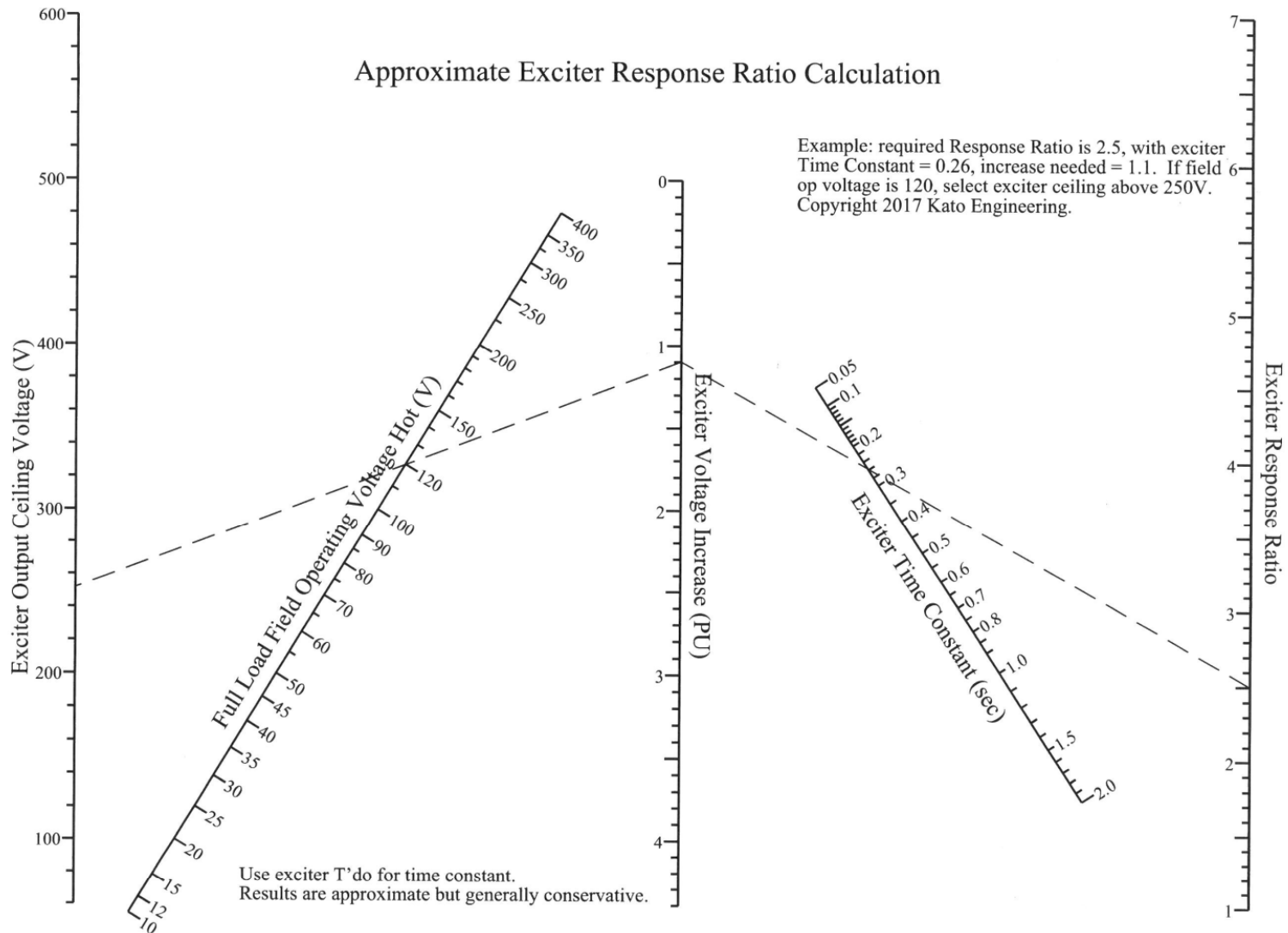

7. Decrement Curves

- IEEE Std 242 provides a simplified method to calculate generator current delivered into a “hard” three-phase fault applied suddenly and with constant excitation
- Symmetrical three-phase fault is the sum of two decaying exponential functions plus a constant term
- Modifications of this method provide for regulator action that increases excitation following application of the fault. These are not part of any known standard. Basically, we just increase the steady-state excitation relative to the initial value, using an exponential function with short-circuit time constant, whose limit is determined by the exciter ceiling voltage. In the method shown below, this function is represented by e_T , which is constant for fixed excitation.

- Equation for symmetrical AC bolted fault current:

$$i_{ac} = (i_d'' - i_d')e^{-\frac{t}{T_d''}} + (i_d' - i_d)e^{-\frac{t}{T_d'}} + i_d e_t$$

where:

$$i_d = \frac{e_t \frac{I_F}{I_{Fg}}}{X_d} = \frac{e'_i}{X_d}$$

$$i_d' = \frac{e'_i}{X_d'}$$

$$i_d'' = \frac{e''_i}{X_d''}$$

Subtransient term (~0-10 cycles)

e'_i terms represent initial excitation.

$\frac{I_F}{I_{Fg}}$ is the ratio of loaded field excitation to no-load value e_t .

Fault Currents of a Synchronous Machine

- Equation for AC symmetrical bolted fault current:

$$i_{ac} = (i_d'' - i_d')e^{-\frac{t}{T_d''}} + (i_d' - i_d)e^{-\frac{t}{T_d'}} + i_d e_i$$

where:

$$i_d = \frac{e_t \frac{I_F}{I_{Fg}}}{X_d}$$

$$i_d' = \frac{e_i'}{X_d'}$$

$$i_d'' = \frac{e_i''}{X_d''}$$

**Transient term
(~10-100 cycles)**

**e_i' terms
represent initial
excitation.**

**$\frac{I_F}{I_{Fg}}$ is the ratio of
loaded field
excitation to no-
load value e_t .**

- Equation for AC symmetrical bolted fault current:

$$i_{ac} = (i_d'' - i_d')e^{-\frac{t}{T_d''}} + (i_d' - i_d)e^{-\frac{t}{T_d'}} + i_d e_i$$

Constant term

where:

$$i_d = \frac{e_t \frac{I_F}{I_{Fg}}}{X_d}$$

$$i_d' = \frac{e_i'}{X_d'}$$

$$i_d'' = \frac{e_i''}{X_d''}$$

e_i' terms represent initial excitation.

$\frac{I_F}{I_{Fg}}$ is the ratio of loaded field excitation to no-load value e_t .

Fault Currents of a Synchronous Machine

- The preceding terms are AC, meaning they have a sinusoidal variation at the generator output frequency as shown below.

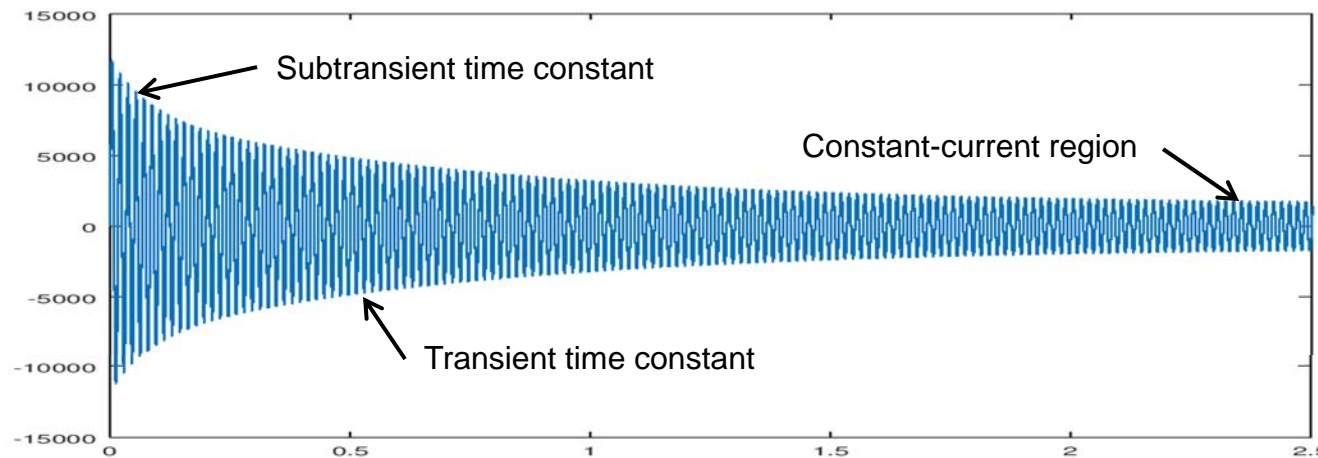

Fault Currents of a Synchronous Machine

- Asymmetrical fault current adds the DC offset term, which varies depending on the instant of fault initiation and the phase being considered
- For decrement curves, we usually assume the worst case for the DC offset term, which is:

$$i_{dc} = \sqrt{3}i_d'' e^{-\frac{t}{T_A}}$$

- Note this is a DC term and has no sinusoidal variation

Fault Currents of a Synchronous Machine

- Adding the DC term gives the complete short-circuit current waveform:

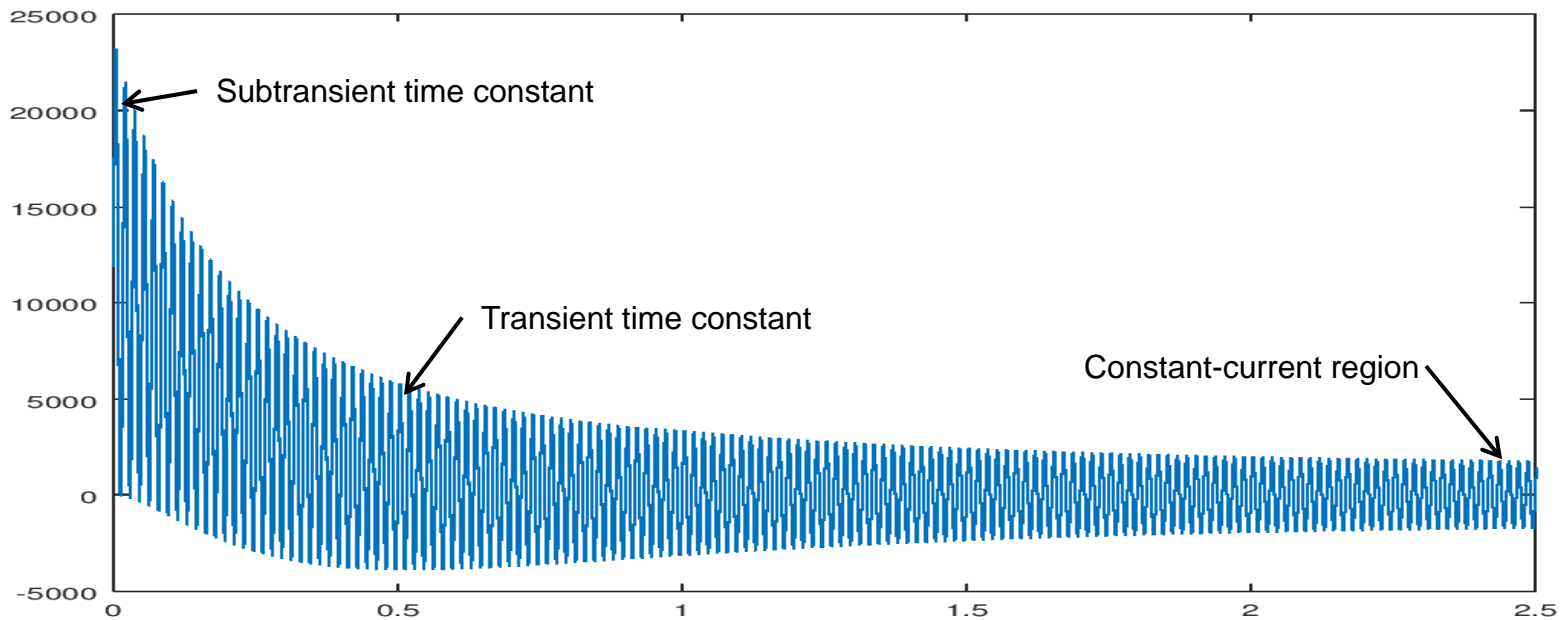

8. Synchronization and Paralleling

Synchronization and Paralleling

- Why operate generators in parallel?
 - Add capacity:
 - Limitations on engine/generator size
 - Modularity for expansion, flexibility of operations
 - Multiple locations
 - Redundancy
 - N+1 allows one set to fail or be maintained while others deliver required load power
 - Improves reliability from 98% to 99.96% (typical system)
 - Efficiency
 - During light load conditions, sets can be shut down so remaining ones operate closer to full load
 - Prevent “wet-stacking” and engine damage

Synchronization

- Involves preparation of two power buses for being connected together. One is usually just called the “bus” and the other, “oncoming”, is the machine or set of machines being added to the bus
- Transient currents and torques occur that depend on the instantaneous voltage difference between the two buses at the moment of connection, and the impedance of the two buses
- Voltage and phase angle contribute to this voltage difference
- Speed (i.e. frequency) difference is also important

Synchronization and Paralleling

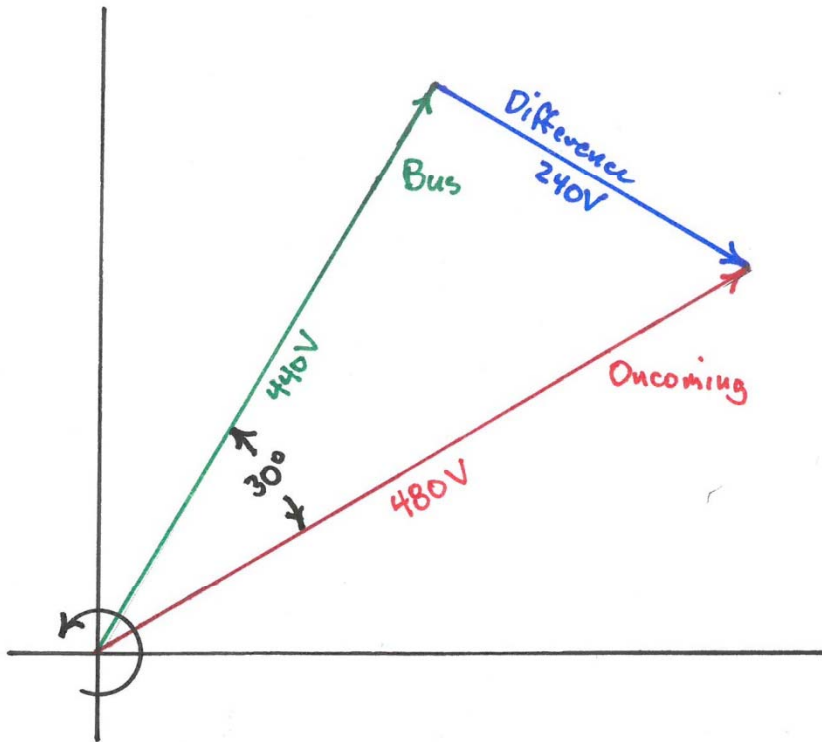

- Difference is due to combination of angle and voltage
- 240V difference is about half rated voltage, so will produce about half of normal short-circuit current and torque
- 10-15° and 5% voltage difference are typical generator requirements for synchronization

Parallel Operation

- When a generator is operating in parallel with a bus (or another generator), it must be controlled in order to balance both reactive (VAR) and real (power) load
- Real power is controlled entirely by the engine or prime mover via the governor. The generator itself has no control over power.
- Reactive load is controlled by the generator excitation alone. The prime mover can't control the VARs (much).

Parallel Operation – Droop Mode

- Droop mode is the simplest method of parallel operation
- For control of VARs, the voltage regulator is set so that as the voltage decreases, it applies more excitation (attempting to increase the voltage), but allows the voltage to decrease slightly in proportion to the VARs being drawn by the load. Requires a current transformer to sense the reactive current.
- The voltage serves as the signal that controls the generator excitation, and varies with reactive load

Parallel Operation – Droop Mode

- Similarly, for the engine, if the speed decreases, the governor applies more fuel (attempting to increase the speed), but allows the speed to decrease slightly in proportion to the power being drawn by the load
- The speed serves as the signal that controls the engine, and it varies with power load
- Droop mode is best for systems with widespread or diverse generation, or paralleled with the grid

Parallel Operation – Cross-Current Mode

- Cross-current mode is more complex and requires a separate channel of communication between generators
- For control of VARs, the voltage regulators are cross-connected to that as the reactive current becomes unbalanced, more excitation is applied to the machine producing fewer VARs and less to the machine producing more, rebalancing the currents. The voltage remains constant.
- The signal that controls the generator excitation is carried on a separate pair of wires

Parallel Operation – Isochronous Mode

- For the engine, this mode is known as isochronous or constant-speed. If the power becomes unbalanced, the governor applies more signal to the lower-power machine, and decreases the power to the higher power machine. Speed does not vary.
- The signal that controls the engine is carried on a separate channel between the governors
- As far as I know, nothing prevents these two types of control from being mixed (e.g. droop voltage and isochronous speed)
- Isochronous/cross current modes are best for systems of like machines in close proximity

Synchronization and Paralleling

- Paralleling of generators with different third harmonic may require special attention as explained elsewhere
- Accidentally synchronizing generators with phase angle or voltage difference beyond the recommended range may cause internal damage to the generators due to high currents, or to the shaft or engine due to high torques
- A method of synchronizing several generators exists where the generators are connected to the (dead) bus and excitation is applied before the engines are started. As the engines come up to speed, the generators are drawn naturally into synchronism.

9. Ten Common Questions for Specifying Generators

Top Ten Questions

1. When specifying a generator, should I select 2/3 pitch, “optimal” pitch, or some other specific value?
2. How do I specify a generator for non-linear loads?
3. What effect does efficiency have on capital and operating costs, and how should I interpret efficiency specifications?
4. What is the difference between saturated and unsaturated reactances, and why should I care? What do the different generator reactances mean, and how do they affect performance?
5. Should I specify “Across the Line” or “Reduced Voltage” for motor starting when specifying a generator? How can I calculate voltage dip with motor starting?

Top Ten Questions

6. What are the different types of windings used in generators, and what type should I specify?
7. What is the benefit of a “close-coupled” adapter between the generator and the engine?
8. Why do bearings on some machines need to be replaced every 8000 hours, and others last 30,000 hours or more?
9. What determines the voltage and current rating for the diodes used in the rotating rectifier? When is a surge arrester used?
10. What is the best way to clean a generator and be a good environmental citizen?

1. When specifying a generator, when should you select 2/3 pitch, optimal pitch, or some other specific pitch?

Generator Pitch - Harmonics

Fundamental & Harmonic Voltages vs. Pitch (Knoltons Handbook)

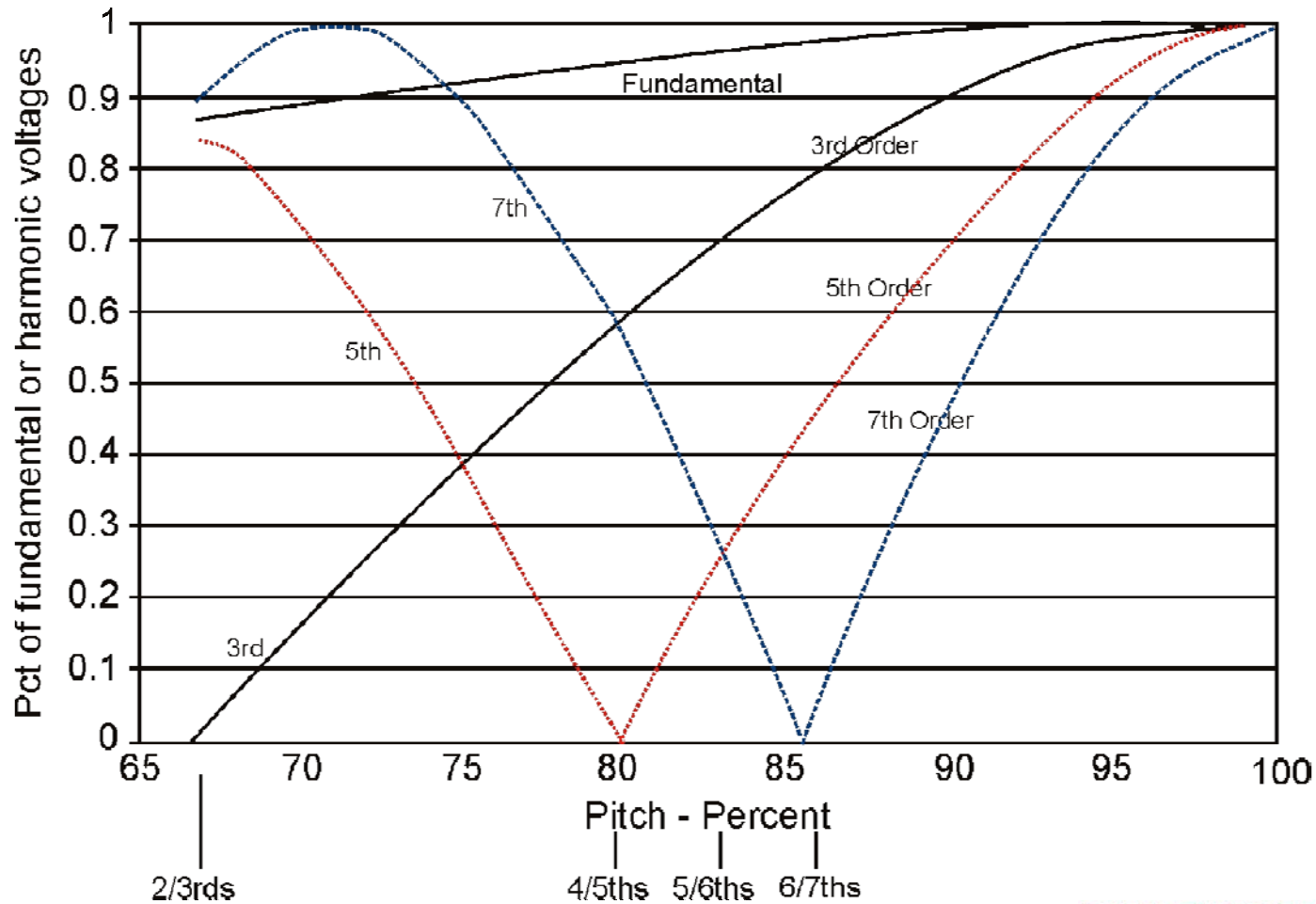

Effects of Generator Pitch (cont.)

- Pitch factors for *reduction* of various harmonics:

Pitch	Harmonic Number						
	Fund	3	5	7	9	11	13
2/3	0.866	0.000	-0.866	0.866	0.000	-0.866	0.866
11/15	0.914	-0.309	-0.500	0.978	-0.809	0.105	0.669
3/4	0.924	-0.383	-0.383	0.924	-0.924	0.383	0.383
7/9	0.940	-0.500	-0.174	0.766	-1.000	0.766	-0.174
4/5	0.951	-0.588	0.000	0.588	-0.951	0.951	-0.588
5/6	0.966	-0.707	0.259	0.259	-0.707	0.966	-0.966
6/7	0.975	-0.782	0.434	0.000	-0.434	0.782	-0.975
7/8	0.981	-0.831	0.556	-0.195	-0.195	0.556	-0.831
Full	1.000	1.000	1.000	1.000	1.000	1.000	1.000

(Harmonic in flux wave is multiplied by reduction factor)

Effects of Generator Pitch (cont.)

- Circulating current: When two generators (or generator and utility) are connected in parallel and third harmonic current flows between them depending on zero-sequence impedance and difference of 3rd harmonic voltages.

$$I_C = \frac{V_{3A} - V_{3B}}{3 \cdot (X_{0A} + X_{0B})}$$

Where:

- V_3 is L-N third harmonic voltage
- X_0 is zero-sequence reactance of each source (including external grounding reactance)

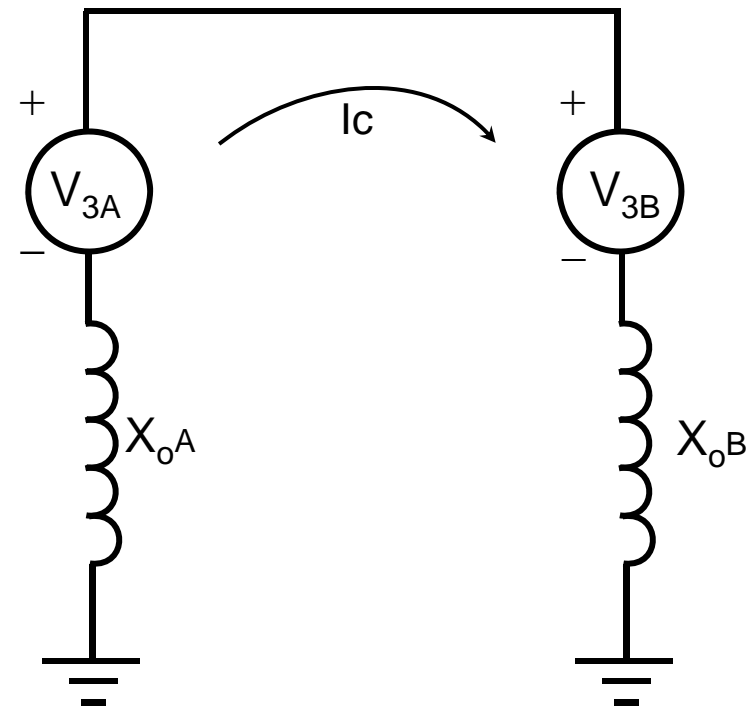

Effects of Generator Pitch (cont.)

- Higher harmonics (5th and up) are not usually significant:
 - Don't appear in neutral lead
 - Higher impedance at higher frequencies means harmonic current is lower
- Third harmonic flows in neutral, causing false tripping of differential protection relay and other problems

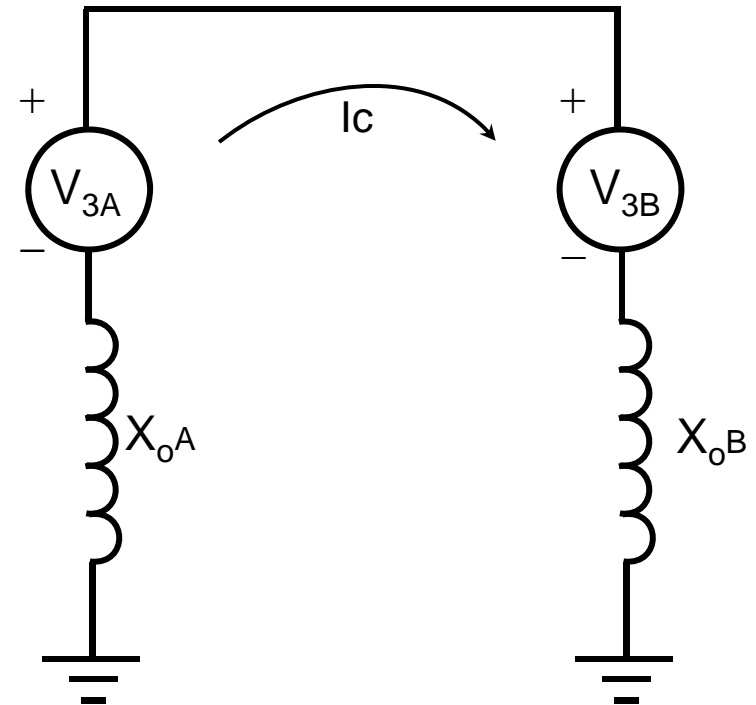

Selection of Correct Pitch (cont.)

- Why not just use 2/3 pitch?
 - Low zero-sequence impedance will cause generator to attempt to absorb any third-harmonic current on bus from other sources. Must balance third harmonic voltage to prevent circulating current.
- Why do other manufacturers have a different recommendation?
 - If building mainly low-voltage machines, these are usually solidly grounded and will more likely require 2/3 pitch for utility paralleling
 - May have made design decision to allow high third harmonic in flux wave, and reduce by making all units 2/3 pitch

2/3 Pitch:

- Kato generators are designed for optimum pitch unless otherwise specified
- Pole pitch is the angle between adjacent poles, i.e. 4 pole = 90° mechanical
- Winding pitch is the coil span divided by the pole pitch, i.e. $60^\circ / 90^\circ = 2/3$
- Optimum pitch balances generator performance while effective utilization of generator active materials
- 2/3 pitch used when paralleling different generators and in conjunction with nonlinear L-N loads. May require derating

Selection of Correct Pitch

- **Paralleling directly with utility bus, solid ground, 480V up:**
 - Normally no line-neutral loads, no load third harmonic generated locally
 - No third harmonic from utility due to transformer connection
 - *Use 2/3 pitch* to minimize circulating current with utility

Selection of Correct Pitch (cont.)

- **Paralleling with utility, high impedance grounding:**
 - Third harmonic circulating current cannot flow through neutral
 - *Use optimum pitch* to minimize cost
 - In most cases systems with high-impedance ground will not require 2/3 pitch. Consulting engineer for project should determine allowable neutral voltage. Pitch to reduce 5th and 7th harmonics.

Selection of Correct Pitch (cont.)

- **Paralleling with other generators, same type:**
 - Since all generators matched, no circulating current
 - *Use optimum pitch* to minimize cost

Selection of Correct Pitch (cont.)

- **Paralleling with other generators, different type, solidly grounded:**
 - Must know third harmonic voltage on bus
 - *Select pitch and slots* to match third harmonic voltage, minimize circulating current
 - *May not* be same pitch as other generators on bus. Depends on pole shape, saturation, other factors
 - Must involve engineers at Kato and end user in design

Selection of Correct Pitch (cont.)

- **Not paralleled, but high harmonic line-neutral load:**
 - Normally 120/208 volt or possibly 277/480V systems.
 - *Use 2/3 pitch* to minimize zero-sequence reactance, to reduce third harmonic L-N voltage.
- **Not paralleled, but only line to line loading:**
 - Many industrial 480V systems and almost all medium- and high-voltage systems.
 - *Use optimum pitch* to minimize cost.

2. How do I specify a generator for non-linear loads?

Sources of Harmonics

- Arc furnaces
- Transformers
- Fluorescent lamps
- Rotating machines
- SCR (Thyristor) controlled devices
- Adjustable speed drives
- Battery chargers
- Pulse width modulated devices
- Switchmode power supplies
- Adjustable speed drives

Load Induced Harmonics

- Notching caused by SCR loads can cause false triggering of electronic equipment (including generator voltage regulator)
- May stress generator insulation because of high rate of voltage change

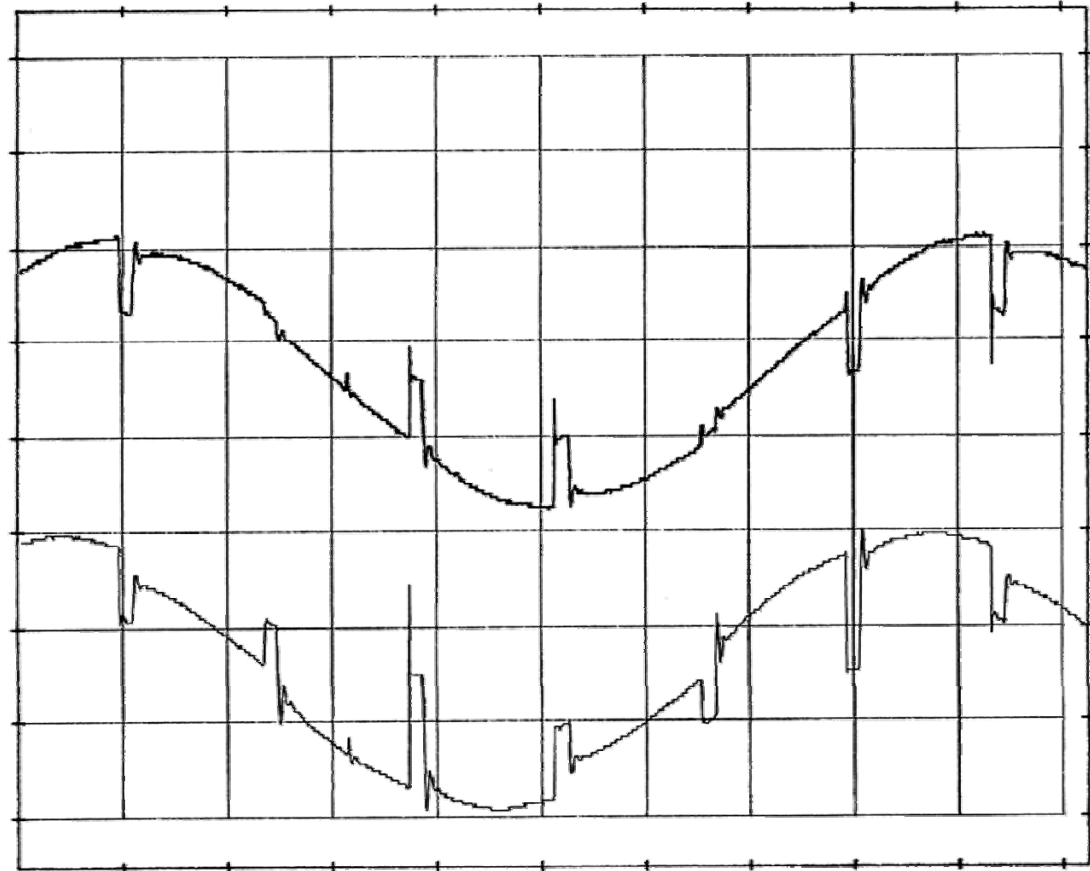

Notching Caused by SCR Load

Other Problems Caused by Harmonics:

- Overheating of generator because of currents induced in damper winding, requiring derating of generator
- Overheating of motors operating on the same system, high audible noise, torque ripple
- Overheating of transformers due to harmonic flux core losses
- Overcurrents in power factor correction capacitors
- Overvoltages or overcurrents in electronic equipment

IEEE 519

- “Recommended Practice” at the moment -- not enforceable except to the extent included in customer specifications
- Intended to limit *load induced harmonic currents* to acceptable levels at the *utility point of common coupling*
- Not a specification for equipment providing power (Nevertheless, we often see it used in this way)
- Unless individual load harmonic currents and frequencies are specified, there is no way to determine if requirements will be met

Sizing of Generators to Meet Specific Harmonic Voltage Requirements:

- We can only guarantee harmonics at the generator terminals: no control over impedances between generator and load
- The customer must obtain a harmonic load flow study by a competent licensed professional engineer to determine harmonic voltages in the total system (not within our scope of supply). We offer information on the generator to facilitate.
- Primary requirement is for low internal generator impedance
- Appropriate value is negative-sequence reactance, which is approximately equal to subtransient (X''_d) for units with connected damper cage. (May conflict with short circuit current requirement.)

Harmonic Calculation

- Load harmonics assumed to be current source. Load impedance disregarded.
- Generator negative-sequence reactance, or subtransient reactance, *at harmonic frequency*, used to determine harmonic voltage:

$$V_h = I_h \cdot X_h \cdot N_h$$

where I_h is harmonic current, X_h is generator reactance at 60 Hz, and N_h is harmonic number.

- Lower reactance = lower harmonic voltages
- Take RMS of voltages for THD

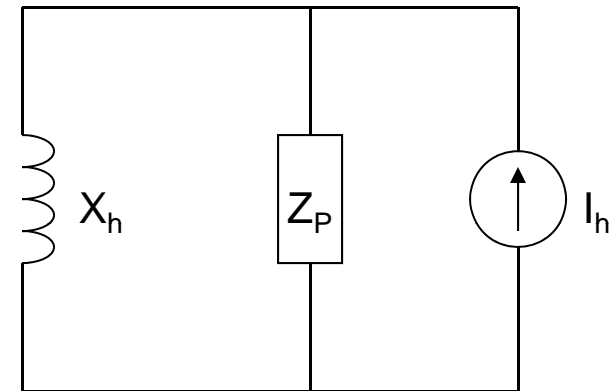

Harmonic equivalent circuit
 Z_p is parallel impedance of filter or other equipment

Methods for Decreasing Generator Reactance:

- Use *larger generator*: This is principal method.
- Use lower turns or pitch, fewer slots, to increase saturation:
 - Increases core losses, increasing temperature rise, decreasing efficiency
 - May be acceptable if machine is oversize anyway
- Kato generators have fully-connected (continuous) copper damper cage (amortisseur winding):
 - This makes the direct- and quadrature-axis subtransient reactance approximately equal
 - Negative-sequence (harmonic) impedance is low
 - Distortion caused by unbalanced load is minimized

Sinusoidal-Current Rectification

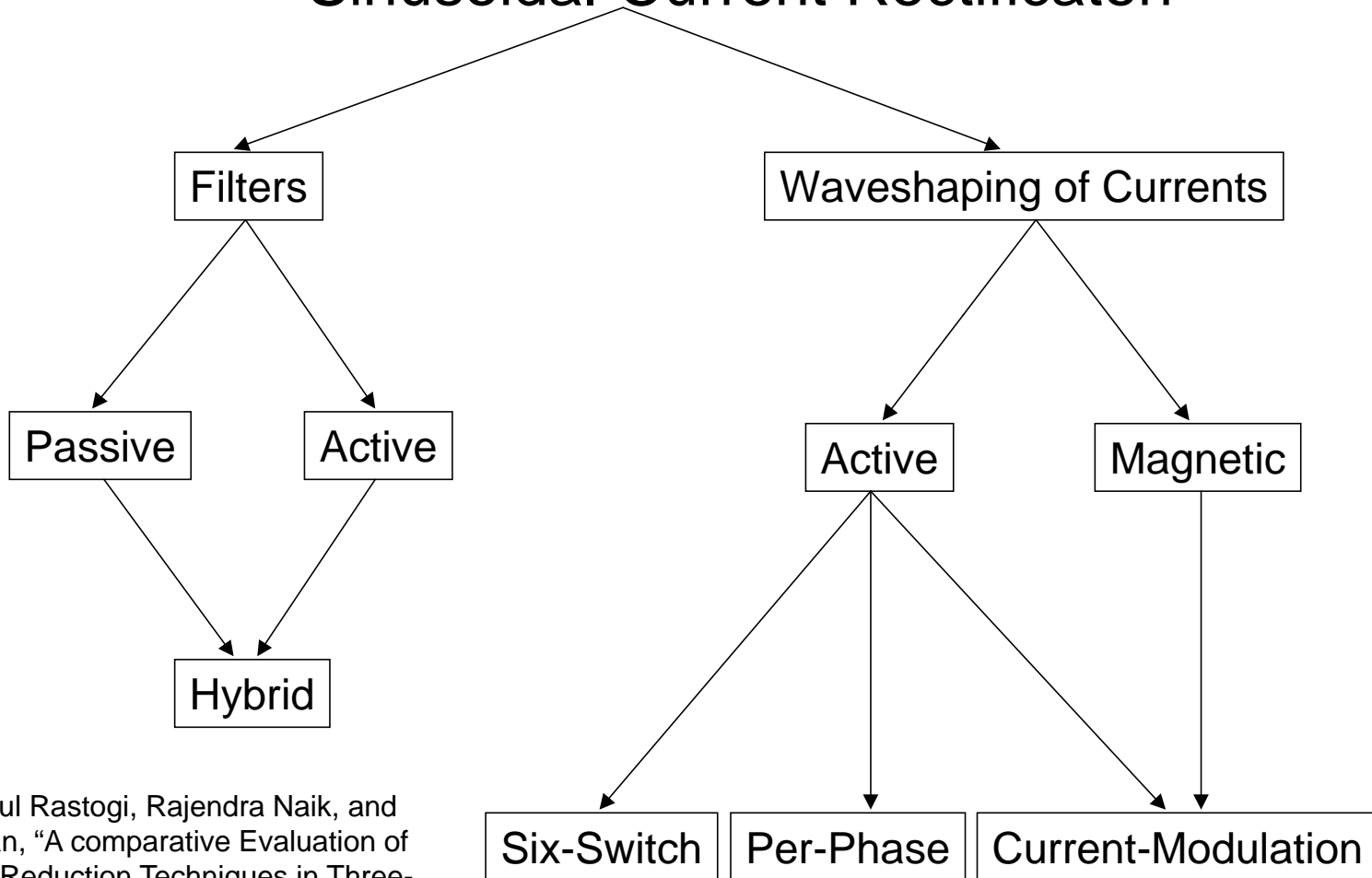

From Mukul Rastogi, Rajendra Naik, and Ned Mohan, "A comparative Evaluation of Harmonic Reduction Techniques in Three-Phase Utility Interface of Power Electronic Loads," IEEE Trans. Industry Applications, Vol. 30, No. 5, Sept./Oct. 1994

Other Harmonic Mitigation Methods

- Harmonic filters
 - Large, expensive, complex to design (must be applied with careful analysis of total system harmonic flow by expert, due to possibility of resonant condition)
 - Can also correct power factor, but care must be used in generator sizing, since instability at low load can result.
- Active filters
 - Even more expensive and complex
 - Much less trouble with resonance but must still be sized carefully
- Load reactors
 - May cause excessive voltage drop
 - Not applicable to all kinds of load

Other Harmonic Mitigation Methods

- **Higher pulse number for converter**
 - Can eliminate fifth/seventh or higher harmonics by cancellation
 - Achieve by design of converter or by using phase shifting transformer for part of load. We can also supply six- or nine-phase generator which can be used in some instances
- **Electronic waveshaping of load current**
 - Generally not practical for large loads

3. What effect does efficiency have on unit cost and lifetime cost, and how should I interpret efficiency specifications?

- Lower efficiency results in higher fuel cost
- A typical example:
 - 2000 kW alternator, “regular” (95.1%) or “premium” (96.1%) efficiency
 - 2800 HP Diesel engine, FL fuel consumption 0.247 l/hr/kWm (US)
 - Est. cost of fuel \$0.52/liter
- With regular efficiency kWm is 2103, so fuel rate is 519 l/hr, or \$270.12/hr
- With premium efficiency, kWm is 2081, so fuel rate is 514 l/hr, or \$267.30/hr. Difference is \$2.82/hr.
- If run 5000 hr per year, savings with premium efficiency will be \$14,100 per year

- Est. cost of regular efficiency generator is about \$150,000 CDN
- Est. cost of premium efficiency is about \$177,000 CDN
- Difference of \$27,000 will take about two years to pay off, assuming no cost of money

- NEMA MG1 vs. IEC 60034 efficiency calculations
 - With IEC standard as amended, there appears to be *no effective difference* between NEMA and IEC efficiency calculations based on segregated losses
 - There is a subtle difference in the test method for stray load loss. IEC does not correct for the armature temperature *during the test* in the same way.

- The losses used to determine the efficiency of a generator for the summation of losses test method are classified as "fixed" losses, which are independent of operating load and "variable" losses, which are dependent upon and caused by the load current.
- Fixed losses cause reduced efficiency as load is reduced. Variable losses generally reduce efficiency as load is increased.

Fixed losses

- Friction and windage losses are due to the bearings and the fans or blowers. In medium to high-speed generators, where the F & W loss is a major contributor, optimizing the fan design can reduce them.
- Core losses are dependent upon the grade of the steel, the magnetization, and the rotor loss. They can be improved by using a lower core loss steel, or by modifying the design to operate at lower magnetization levels. This will affect the generator's ability to accept motor loads. The rotor loss can be reduced by optimizing the stator slot design or using low-loss rotor steel.

Variable losses

- Stray load losses are caused by the load current and are due to changes in the flux distribution, eddy currents, and high-order harmonics. They can be reduced by using higher cost materials. Stranding the armature copper into thinner cross sections will help reduce the eddy current losses in the copper winding. The magnetization level also affects the stray losses; highly saturated machines for improved motor starting exhibit higher stray losses.
- “Stray” losses are so called because they were very difficult to predict and measure. New analytic methods now allow much more accurate quantification of stray losses, and point the way to reducing them.

Variable Losses

- I^2R losses are a function of the load and are calculated from the I^2R formula, where I is the winding current of the armature or field and R is the DC winding resistance at a specific temperature.
 - Armature I^2R losses can be reduced by using insulation with higher dielectric strength and adding more copper. The gain in efficiency can be appreciable on 10-15 kV generators where the insulation cross section area is large.
 - Field I^2R losses can be reduced by controlling the load power factor and reducing the excitation requirements.
 - Brushless exciter losses are caused by the exciter and rectifier assembly and are usually less than 15% of the field I^2R losses. Any improvement is negligible on the total generator efficiency.

4. What is the difference between saturated and unsaturated reactances, and why should I care? What do the different generator reactances mean? How do they affect performance?

Effects of Saturation

- Steel used for rotor and stator laminations has a limited capacity to carry magnetic flux. Once steel is “filled up” with magnetic field, it ceases to be an easy path for additional flux (saturates).
- To get maximum use of steel, parts of machine are somewhat saturated at full voltage, and much more saturated during short-circuit from full voltage. Because of this, reactances are lower under this condition. These are called “saturated” reactances, and are measured during a sudden short-circuit at rated voltage.
- Under conditions not involving full-voltage short-circuits, steel is less saturated, and reactances are higher
- Saturated values should be used for short-circuit events that occur at full voltage, and unsaturated for any other events, such as voltage dip

Saturation

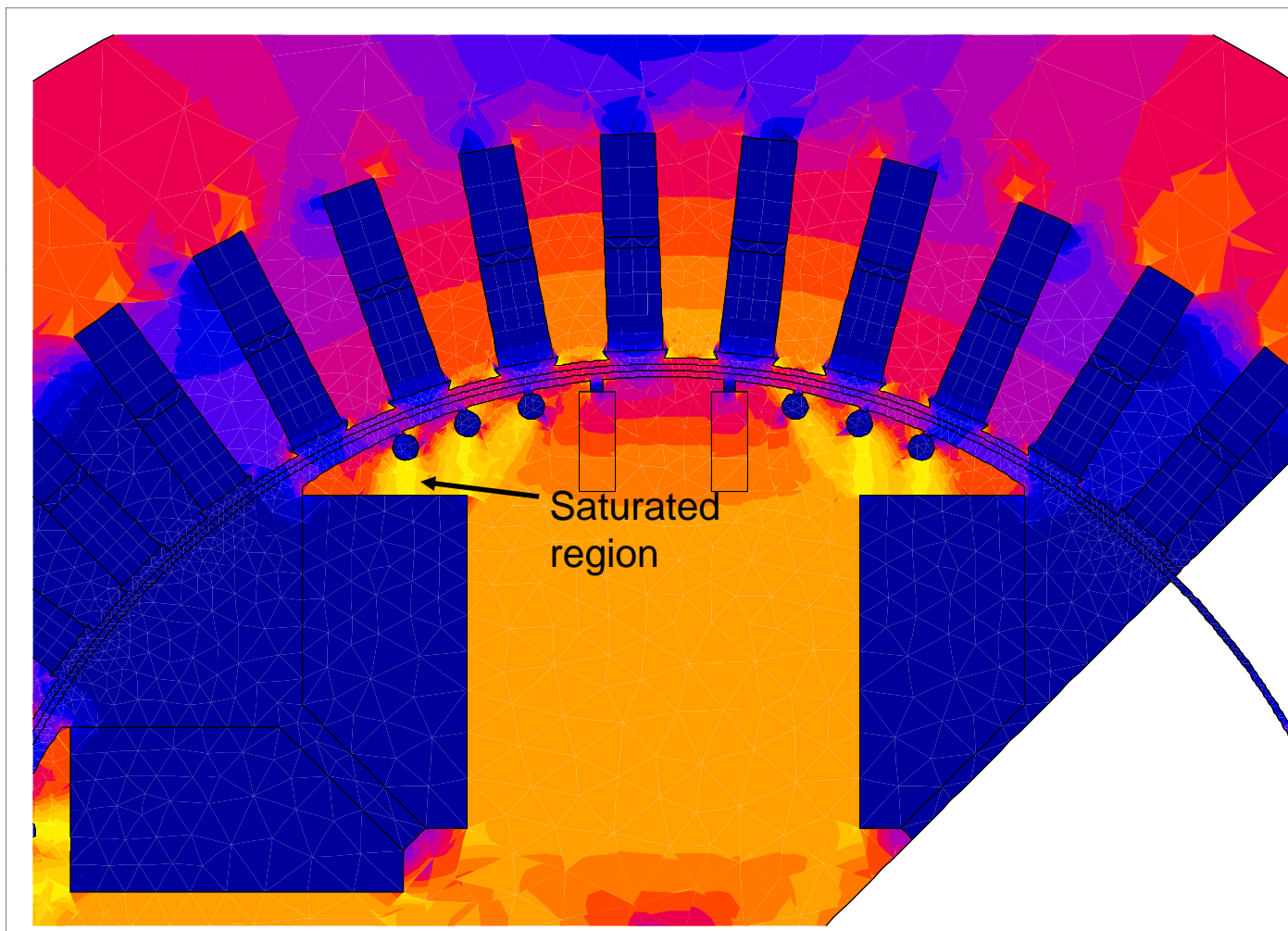

5. Should I specify “Across the Line” or “Reduced Voltage” for motor starting when specifying a generator? How can I calculate voltage dip when starting a motor?

MG 1-2003
Part 32, Page 10

Section IV
SYNCHRONOUS GENERATORS

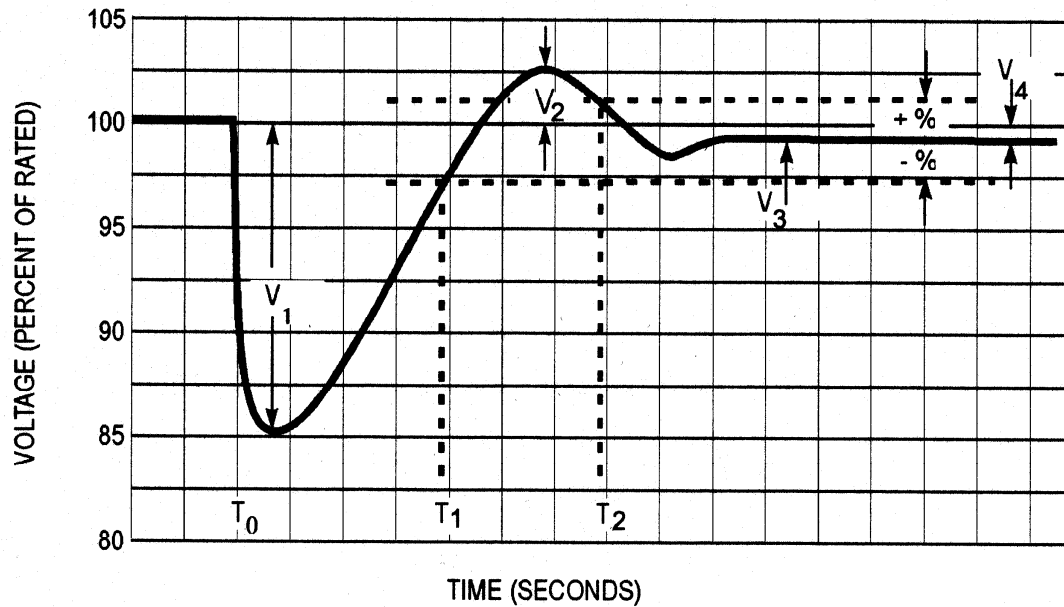

V_1 = Voltage dip

V_2 = Maximum transient voltage overshoot

V_3 = Recovery voltage

V_4 = Steady-state regulator

T_0 = Point at which load is applied

T_1 = Time to recover to a specified band

T_2 = Time to recover to and remain
within the specified band

Figure 32-1
GENERATOR TRANSIENT VOLTAGE VERSUS TIME FOR SUDDEN LOAD CHANGE

Motor Starting

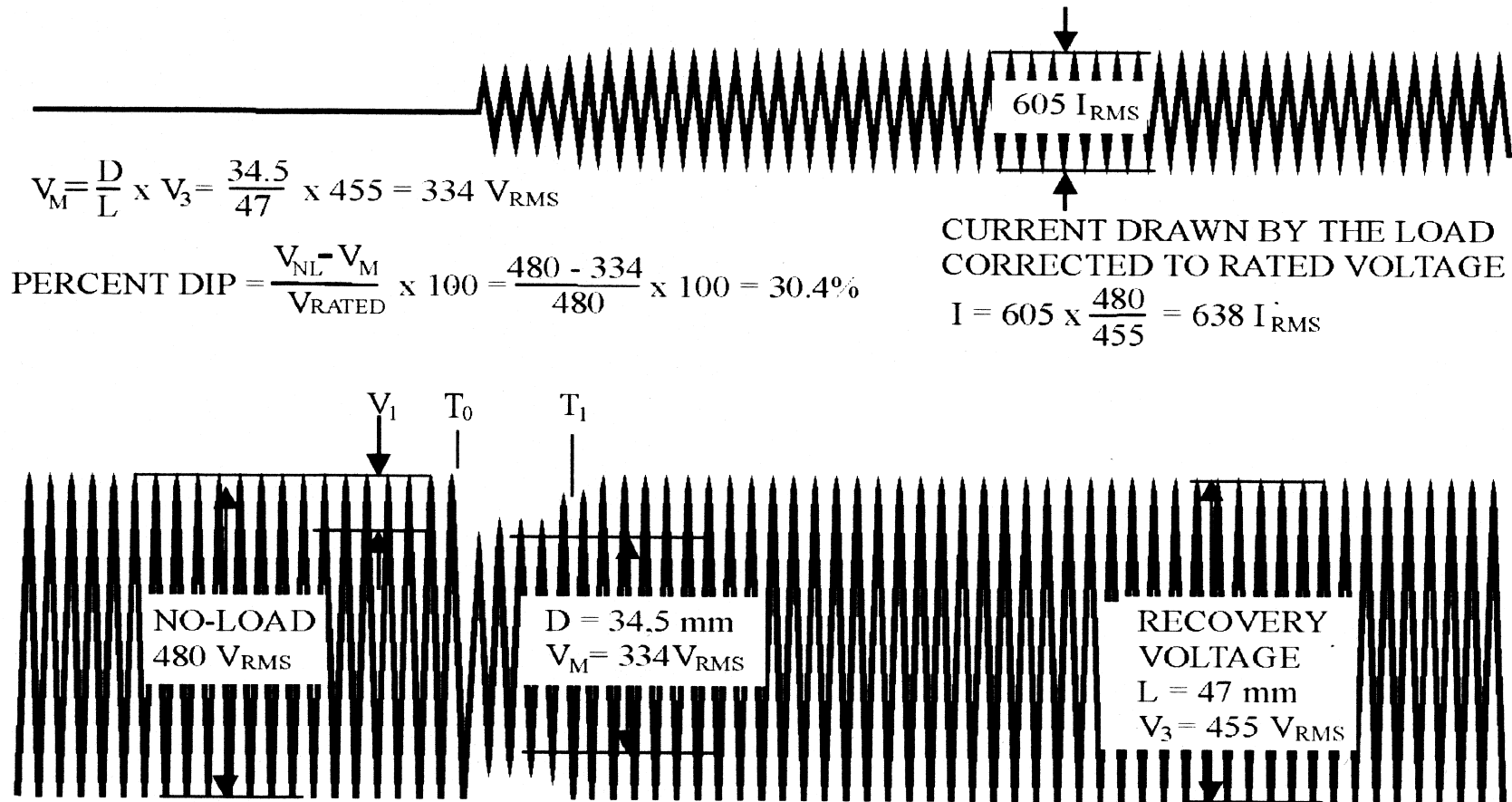

Figure 32-2
GENERATOR TRANSIENT VOLTAGE VERSUS TIME FOR SUDDEN LOAD CHANGE

Motor Starting

From NEMA MG1-2003:

In the absence of manufacturers' published information, the value of voltage dip may be estimated from machine constants, subject to the conditions set forth in 32.18.1 and the following:

- a. Voltage regulator response time \leq 17 milliseconds
- b. Excitation system ceiling voltage* $>$ 1.5
- c. Rated field voltage

$$\text{Voltage dip} = \frac{X'_d}{X_L + X'_d}, \text{ percent}$$

Where:

X'_d = direct axis transient reactance, per unit

X_L = applied load, per unit on generator kVA base

or $X_L = \frac{\text{kVA rated}}{\text{kVA (low power factor load)}}$

Data estimated in accordance with the above calculation should be identified as "Calculated Voltage Dip."

6. What are the different types of windings used in generators, and what type should I specify?

Main Stator Windings

- Pattern – Lap, Wave, Concentric, Pyramidal
- Pitch – $2/3$ pitch and others
- Number of parallel circuit
- Integral slot and fractional slot windings
- Dual level voltage re-connectable
- Slot-fill
- Optimum operational performance
- Different connections – Wye, Delta, ZIG – ZAG

Types of Windings

Random-Wound Stator Slot Detail

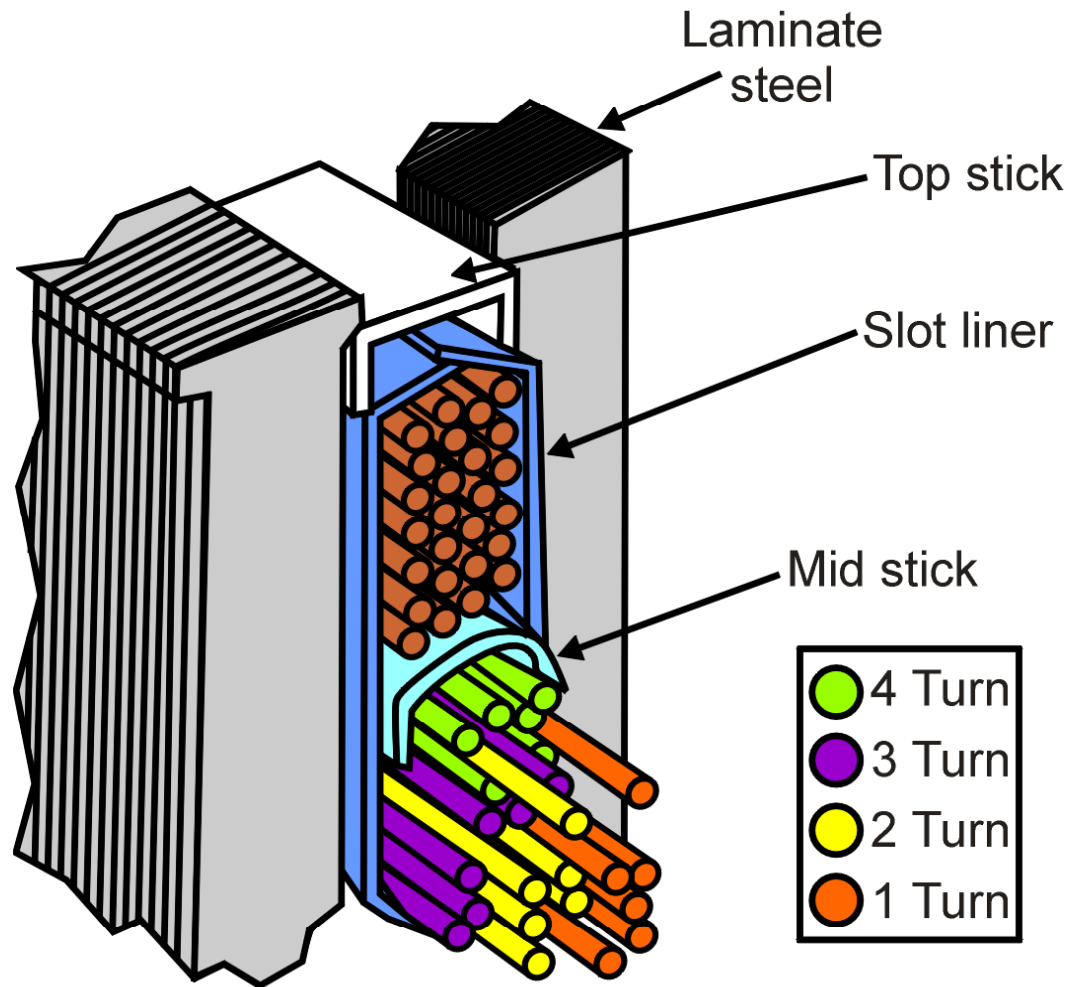

Types of Windings

Form-Wound Stator Slot Detail

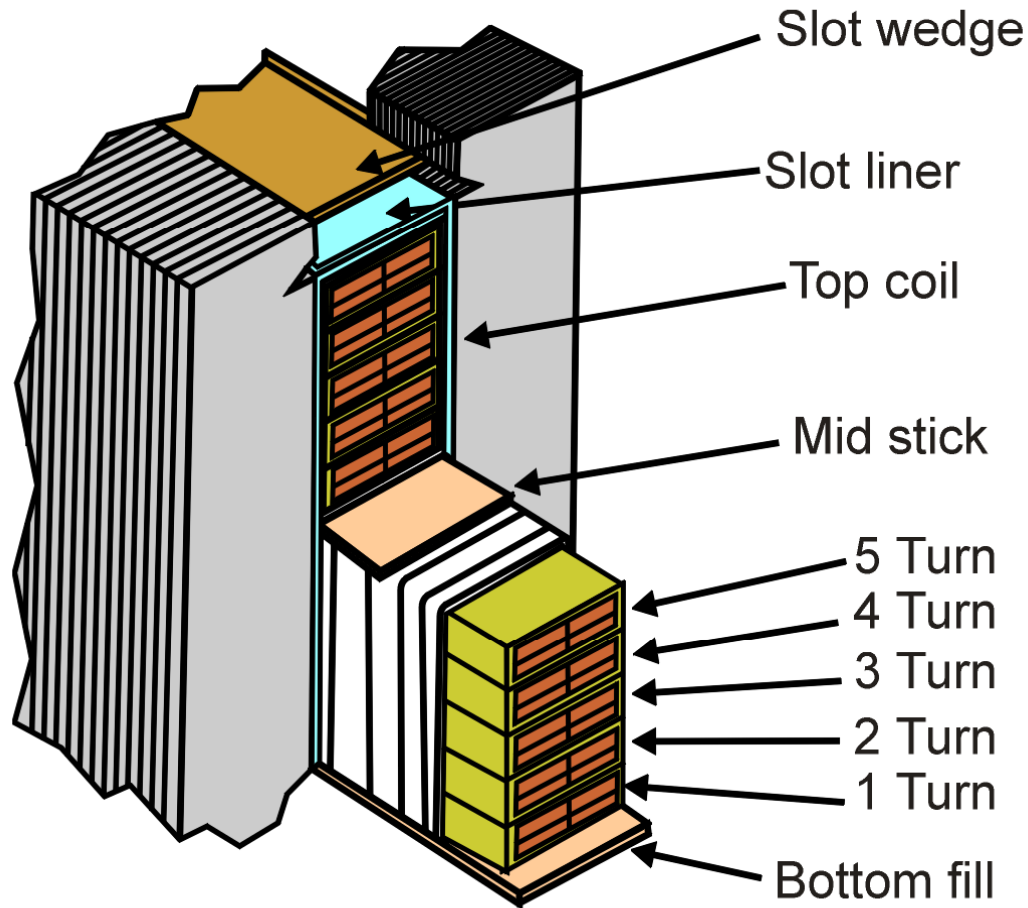

Summary of Differences

Form-wound coils

Magnet wire is rectangular or square with double Dacron glass cover or mica turn tape over 200° C heavy film. The wire is more costly and many different sized wires are required.

Individual turns are systematically arranged throughout the coil

Coils employ insulation tapes

The slots have uniform copper fill. Individual wires are tightly held in the slot.

Coil-to-coil connections are usually required

Random-wound coils

Round wire with 200° C heavy film is used. Fewer sizes need to be kept on hand, and the wire is more economically priced.

Turns have a random location; wires from a turn can touch any other turn

Coils are not taped. 600V maximum

Wires are randomly inserted in the slot, and are relatively loose

Only phase connections are required

High-Voltage Coil

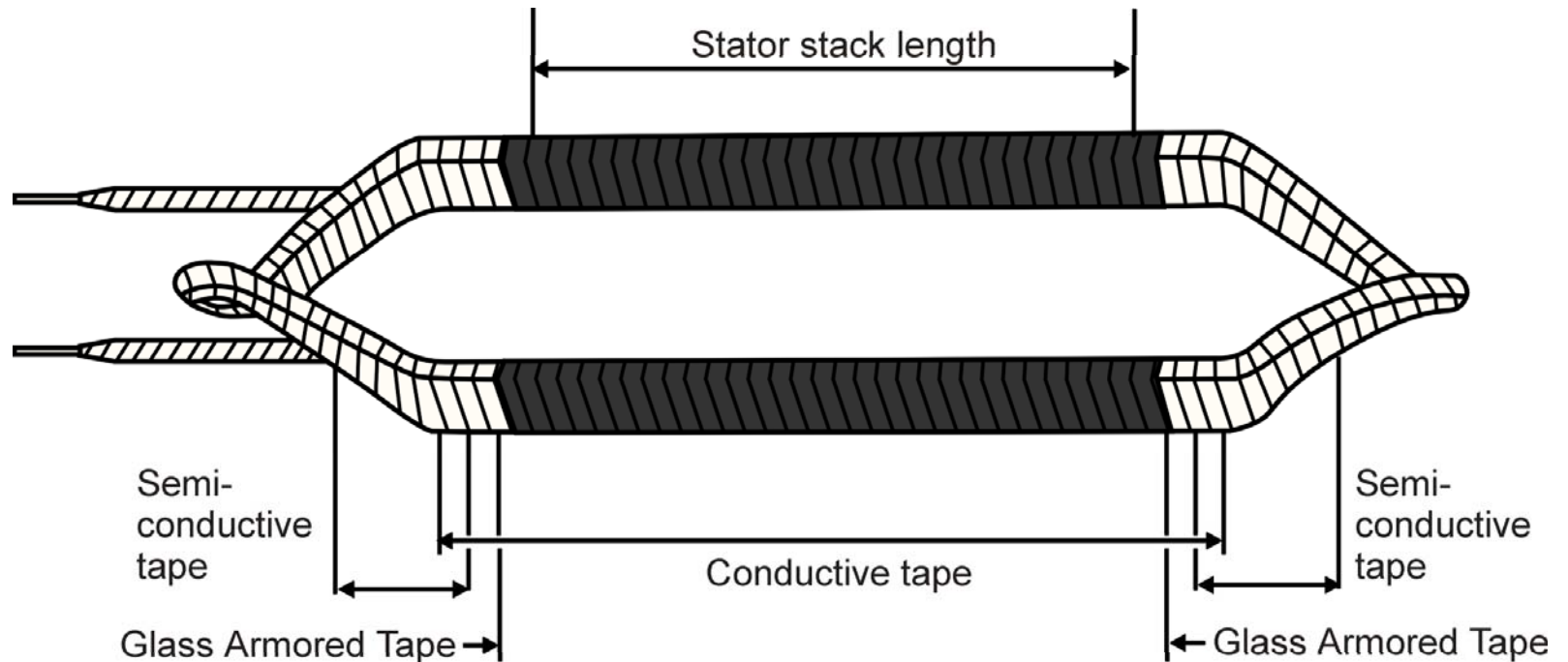

Close Coupled Adapters

7. What is the benefit of a “close-coupled” adapter between the generator and the engine?

Close Coupled Adapters

- The adapter adds stiffness to the system, increasing the critical speed and reducing vibration. It may permit use of a lighter base.
- The overall length of the system may be reduced

8. Why do bearings on some machines need to be replaced every 8000 hours and others last 30,000 hours or more?

Generator Bearings

- Bearings normally last more than 30,000 hours, typically the “L10” life is 40-50,000 hours (time for 10% of bearings to fail, per ABMA standard).
- Premature bearing failure is usually caused by:
 - Vibration (due to unbalance, misalignment, or prime mover problems)
 - Lack of lubrication or wrong type of lubrication
 - Misalignment, excessive thrust, or improper loading
- May also be caused by:
 - Wrong bearing installed, or defective bearing
 - Installation or shipping damage
 - Excessive temperature, dirt & contamination, or corrosive atmosphere
 - Shaft electrical currents (Kato provides insulated bearings)

Bearing Lifetime

- L_{10} calculation (anti-friction)
 - Loads-axial and radial
 - Orientation
 - Generator rotor weight
 - Magnetic forces
- Torque passing through the bearing ID
 - RPM
 - kW rating
 - Shaft material
- Shock loads
- Maximum speed rating (anti-friction)
- Minimum load capability (anti-friction)

Life Cycle Maintenance Cost

- Grease (anti-friction)
 - Interval VS Sealed/Shielded
 - Grease “Valve”
- Oil change interval (sleeve)
 - Oil operating temperature
 - Ambient temperature
 - Oil viscosity
 - Rotor weight
 - Oil type
 - Mineral
 - Synthetic

Generator Bearings

- Ship board
- Oil platform
- High shock

9. What determines the voltage and current rating for the diodes used in the rotating rectifier? When is a surge arrester used?

- Kato customary practice is to rate diodes for three times the peak voltage, and three times the average current at full load
- Allows for overvoltage surges from out-of-phase paralleling, and overcurrent from forcing during short-circuit operation
- Kato uses fast-soft recovery diodes on most products, which do not produce high spike voltages on commutation, so we do not usually use a snubber. A surge arrester is usually fitted “just in case” as it provides a good indicator of out-of-phase paralleling if it is missing or charred.

10. What is the best way to safely clean a generator and be a good environmental citizen?

Generator Cleaning

- Solvents can be recycled, but cause VOC emissions to the atmosphere
- Surfactants and detergents are less environmentally harmful, but may require special disposal if they become contaminated with grease or oil from the generator. Wipe up first to reduce the amount in the water.
 - Drying of the generator is required after exposure to water (using fans, space heaters, etc.)
 - “Sealed” (API) insulation system preferred
- If the dirt and contamination is not conductive and/or easily removed, mechanical brushing or air cleaning may be adequate

Nidec
All for dreams