

Industrial Battery Comparison

saft



a company of



Safety Precautions

- ❑ MSDS Sheets identify chemical hazards
- ❑ Use double insulated tools
- ❑ No smoking or open flames
- ❑ Avoid arcing near the battery
- ❑ Wear personal protective equipment
- ❑ Avoid wearing metal objects
- ❑ Ensure battery area ventilation is operable
- ❑ Neutralize static buildup



SAFT, now proud part of the TOTAL Group*



SAFT DEVELOPS AND MANUFACTURES ADVANCED-TECHNOLOGY BATTERY SOLUTIONS



FOR MULTIPLE APPLICATIONS

- **Diversified** base of industries
- **Broad portfolio of technologies**
(Ni-based, Primary Lithium and Lithium-ion)
- **Leadership positions on 75-80%** of revenue base (Industrial Standby, Metering, Aviation, Rail, Defense, Satellites)

ON A GLOBAL SCALE

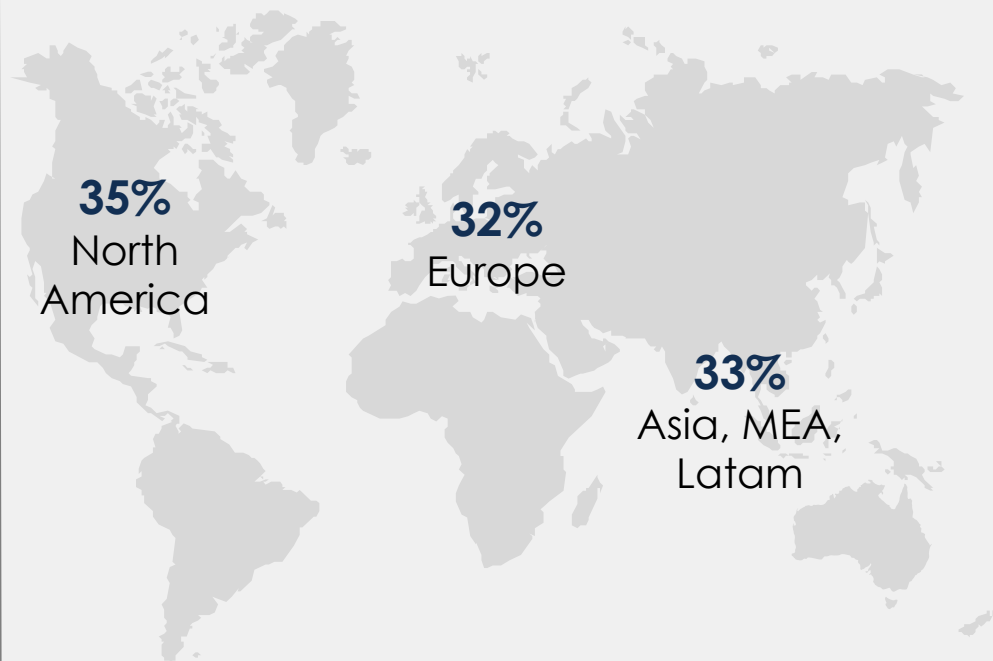

* SAFT is part of TOTAL new division, "Gas, Renewables & Power", since September 1st, 2016

100
years of history

\$921M*
revenue FY 2017

9.7%
invested in R&D

+4,100
people

+3,000
customers

Leading Oil & Gas companies rely on Saft

International & National Oil and Gas Companies

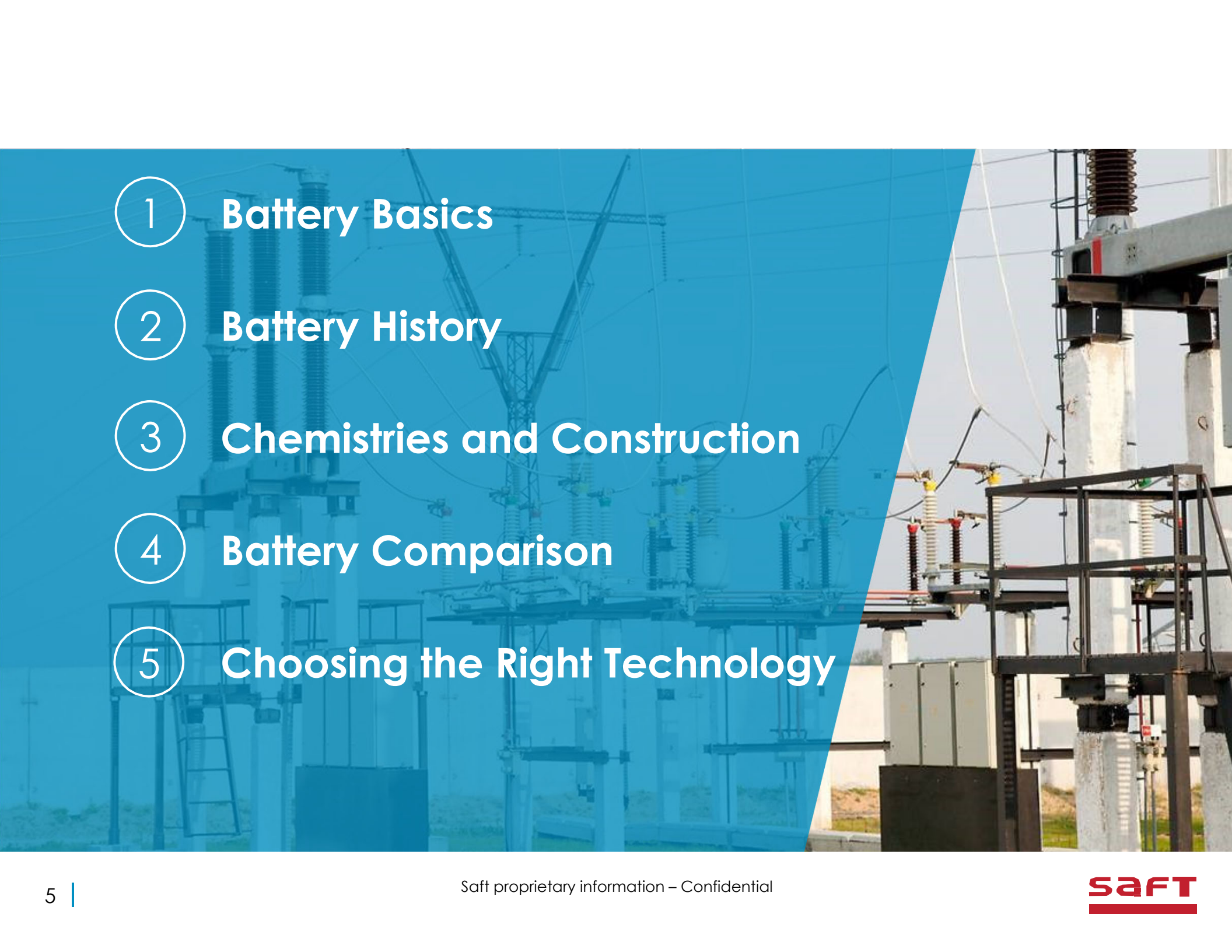

- 
- 1 Battery Basics
 - 2 Battery History
 - 3 Chemistries and Construction
 - 4 Battery Comparison
 - 5 Choosing the Right Technology



1

BATTERY BASICS

Battery Composition

A battery is an electrochemical energy storage device.

Energy Storage

Active Material

Electrolyte



=

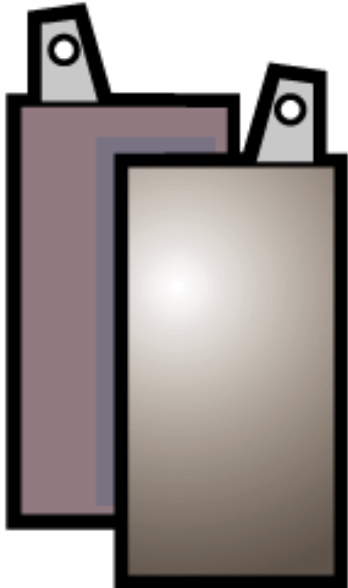

+

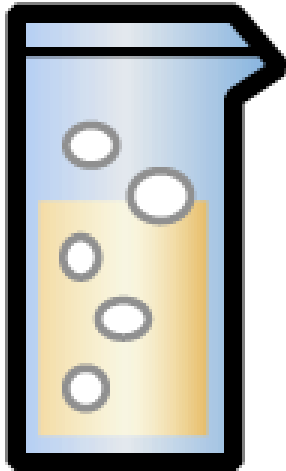

Stationary Battery Cell Components



Substrate

Bones of the battery.

Physical structure inside the battery that houses the active materials.

(May or may not be made of the same material as the active material)



Active Material

The muscles of the battery.

The material that does all the work storing and releasing energy.

Stationary Battery Cell Components

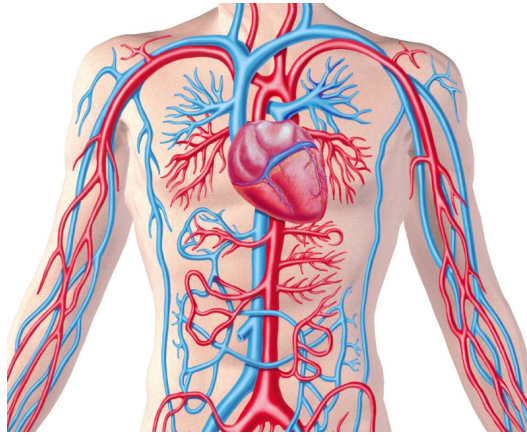

Electrolyte

The life blood of the battery.
Carries energy between the plates.
(May help with energy storage in some battery types)



Case (Jar)

Skin of the battery.
Keeps all the important bits inside!!

Stationary Battery Assembly

Battery System Configurations

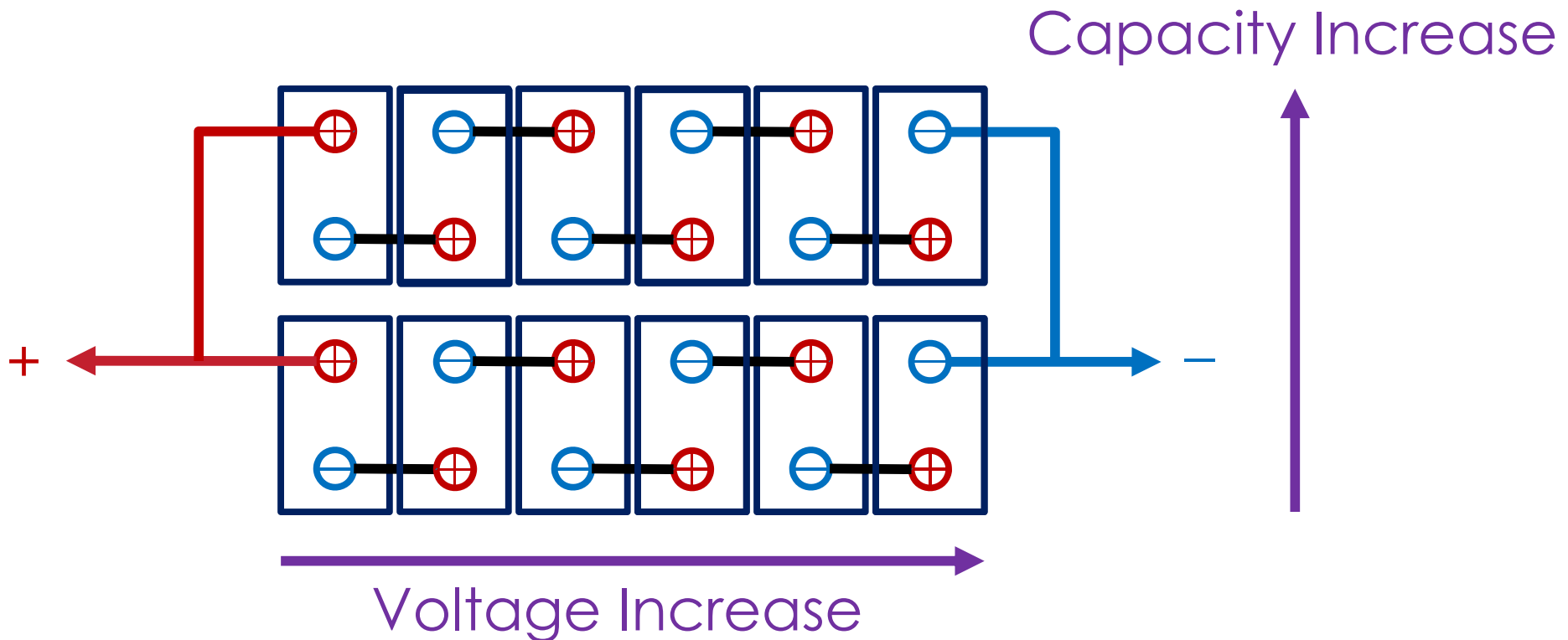

Cells in series increase voltage

Cells in parallel increase capacity

Battery Failure modes

Two Basic Failure Modes

Battery Type A
Fails **open circuit**

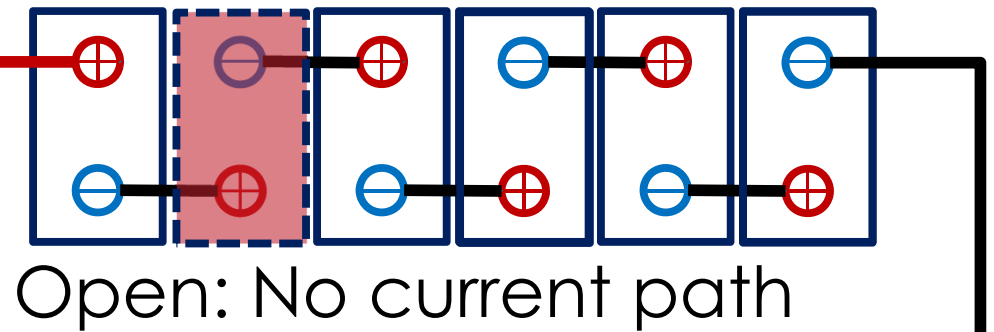

Battery Type B
Fails **short circuit**

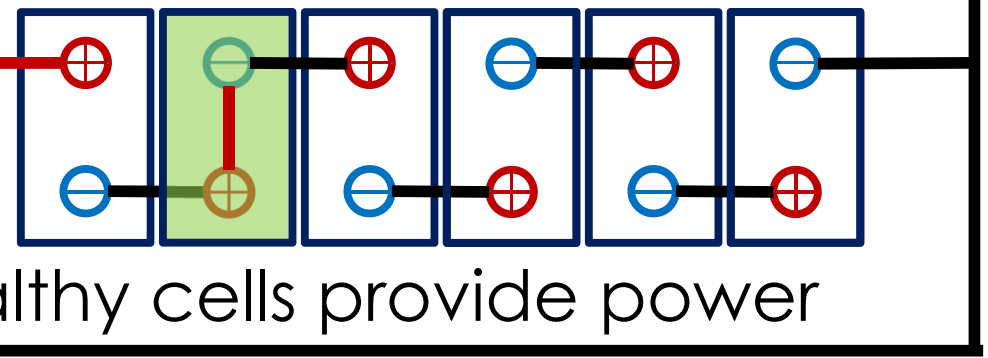

Battery Terms

Ah – Ampere-hours

- Battery's rating of capacity

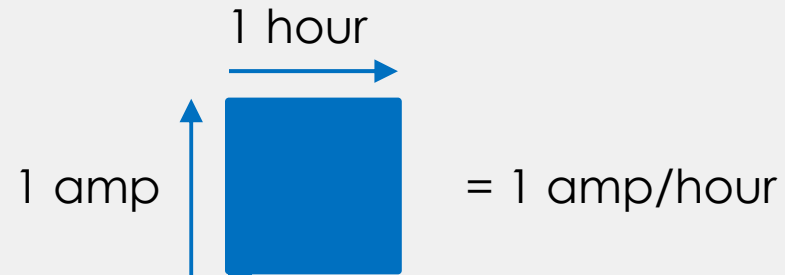

Rated capacity of a battery

- Continuous amps available for a set time period, to a certain end of discharge voltage, at a stated temperature
- Ni-Cd Example: 100Ah = 20A for 5 Hours down to 1.00 Volts/cell at 77°F

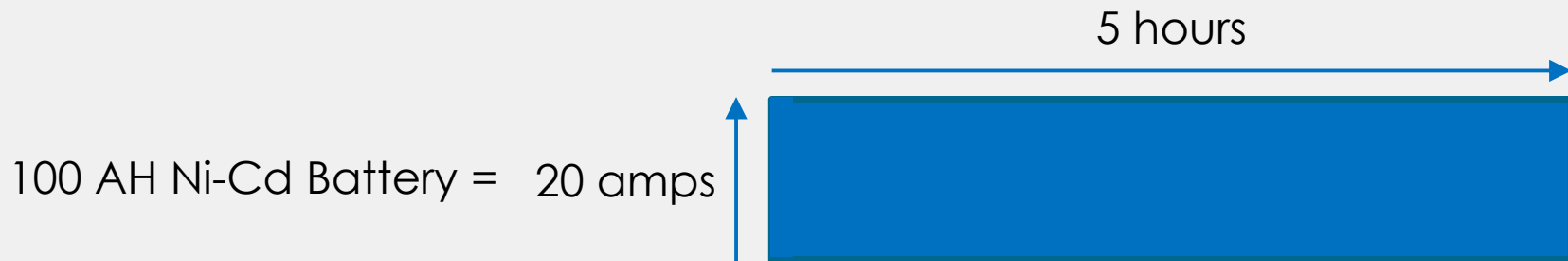

Power = Instantaneous (V x I)

- Example: Switchgear Tripping current, instantaneous power requirement.

Energy = Power x Time

- Example: Continuous current loads for many hours.

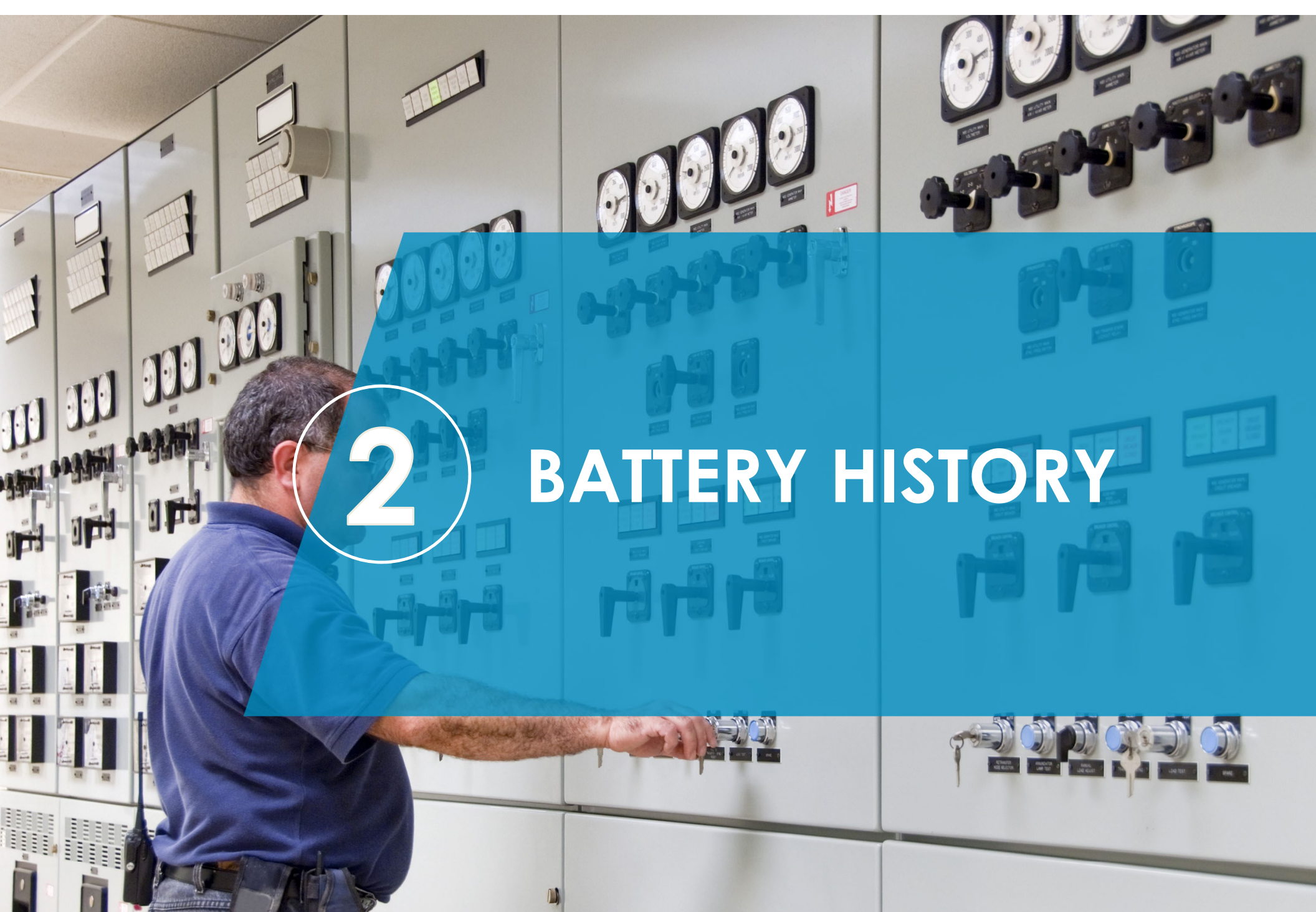

2

BATTERY HISTORY

Battery Basics - History

The Early Days of Batteries

Gaston Plante

- French Physicist
- Invented the first rechargeable (secondary) lead-acid battery in **1859**



Waldemar Jungner

- Swedish Chemist
- Invented the first rechargeable nickel-cadmium battery in **1899**

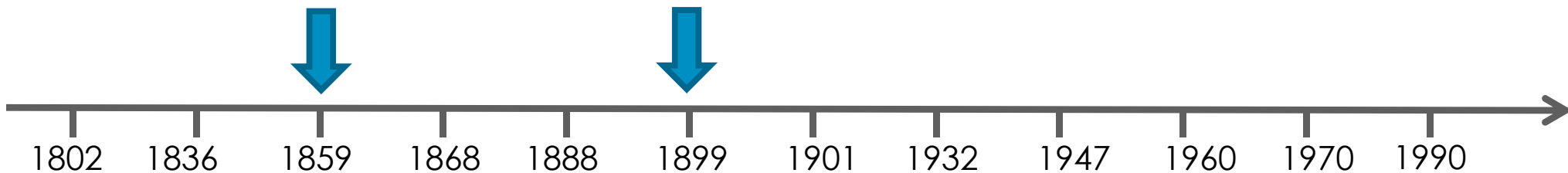
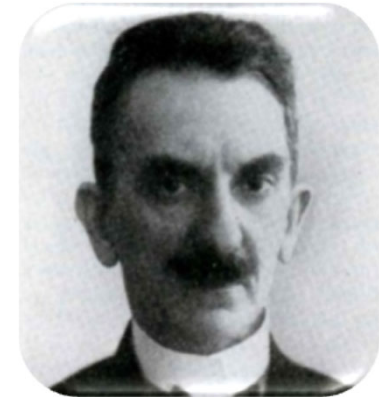

SAFT History

- Founded in 1918 by Victor Herald
- Originally **S**ociété des **A**ccumulateurs **F**ixes et de **T**raction (S.A.F.T.)
- Roughly translates to "Stationary and Traction Battery Company"



Battery Basics - History

Traditional Battery Improvements...

- 1970's: the development of valve regulated lead-acid batteries
- 1980's: Saft introduces "ultra low" maintenance nickel-cadmium batteries
- 2010: Saft introduces maintenance-free* nickel-cadmium batteries
 - *The term maintenance-free means the battery does not require water during it's entire service life (20+ years under Saft's recommended conditions)*

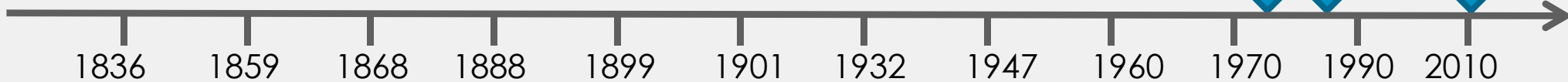
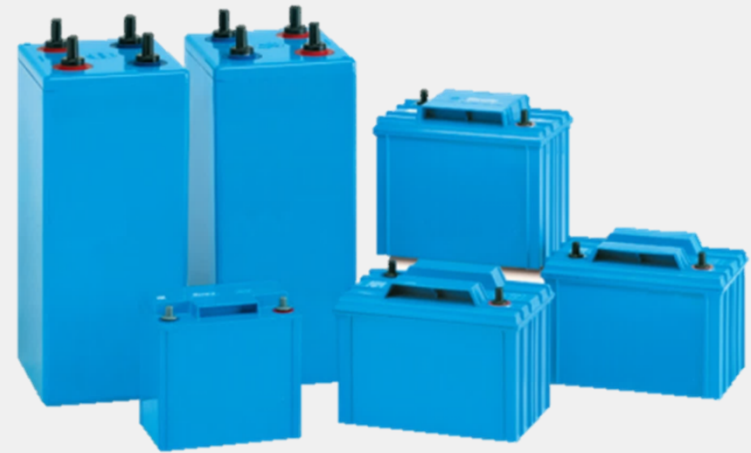

Battery Basics - History

The future of batteries – Lithium-ion

- 1976: Exxon researcher – Whittingham described lithium-ion concept in Science publication entitled “Electrical Energy Storage and Intercalation Chemistry”
- 1991: Sony introduced the first Li-ion cell (18650 format)
- 1992: Saft introduced its commercially available Li-ion cell

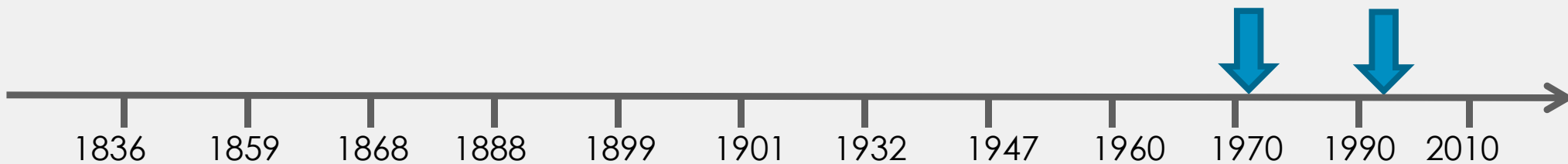



3

CHEMISTRIES & CONSTRUCTION

Lead-Acid Basics

- Plates –
 - Substrate: Pure lead or lead alloy grid
 - Positive Active Material: Lead oxide
 - Negative Active Material: Sponge lead
- Electrolyte - Sulfuric acid (H₂SO₄) 1.205 - 1.275 Specific Gravity and participates in the electrochemical storage reaction
- PH = ~2
- Nominal volts per cell ~2.0
- Inter-cell connection links - usually lead plated copper
- Different Grid Alloys – Selenium, Calcium, Antimony
- Failure mode: **OPEN CIRCUIT**
- Total Reaction

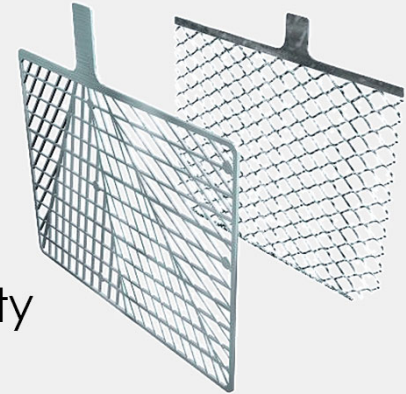

Flooded Lead-Acid Pasted Plate

Basic Specification

- Jars - **S**tyrene **A**crylo**N**itrile (**SAN**) or **P**oly**C**arbonate (**PC**),
- **F**lame **R**etardant - ABS Lid-opaque, **PC** Jar-clear
- Construction: Plante, Manchester, Faure (Pasted Plate), Tubular
- Design Life - 20 years
- Service life - 12 – 15 yrs, depending on environment, design, application



Pasted plates



Tubular plates

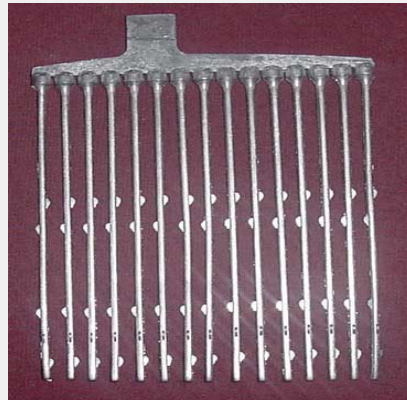

Plante lead plate

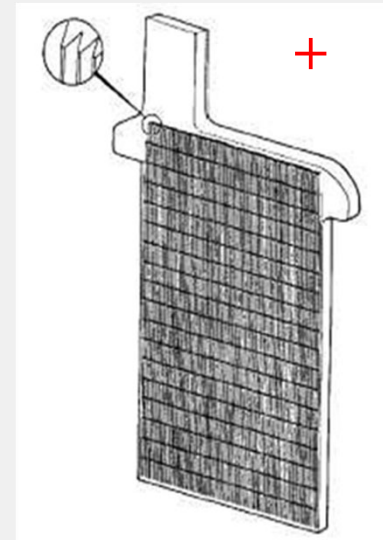

Negative plate

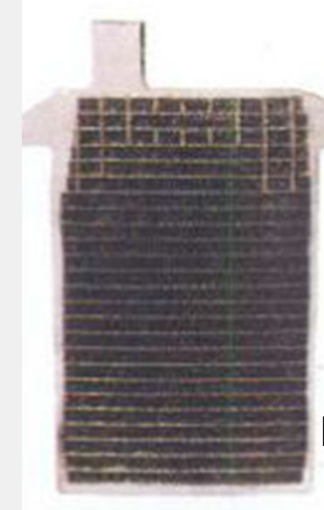

Lead grid

Valve Regulated Lead-Acid Batteries

VRLA or Recombination Technology

- Immobilized electrolyte
 - Absorbed (AGM)
 - Fiberglass mat saturated with acid
 - Gel Cells
 - Silicon gel saturated with sulfuric acid
 - Gas path from positive to negative
- Positive internal pressure
- Recombination process is highly efficient due to low electrolyte content
 - Charging energy is converted to heat
 - Thermal management is critical
- Grid corrosion results in hydrogen evolution
- Typically have FR (Flame Retardant) jars

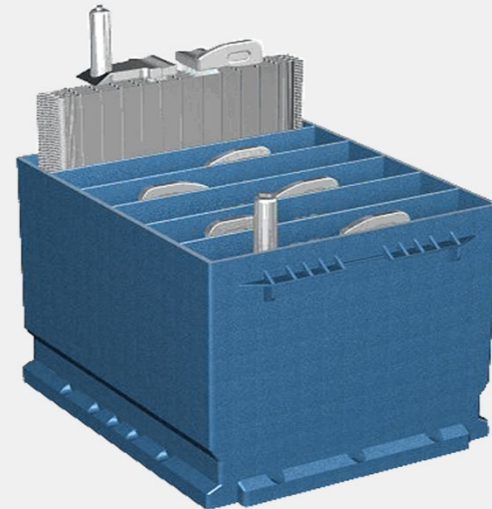
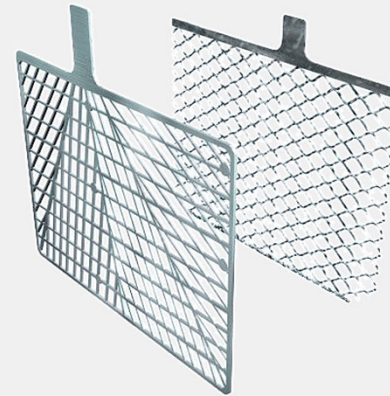

VRLA (continued)

Advantages

- No water additions
- High energy density
- Low initial cost

Disadvantages

- Multiple failure modes
 - Dry out
 - Thermal runaway
 - Negative strap corrosion
 - **Sudden death... OPEN CIRCUIT**
- Highly susceptible to ripple current
- Shorter life than vented cells
- Design Life: 1-11 years
- Service Life: typically 3 – 7 years

Typical Applications

- Telecommunications, UPS, Emergency Lighting

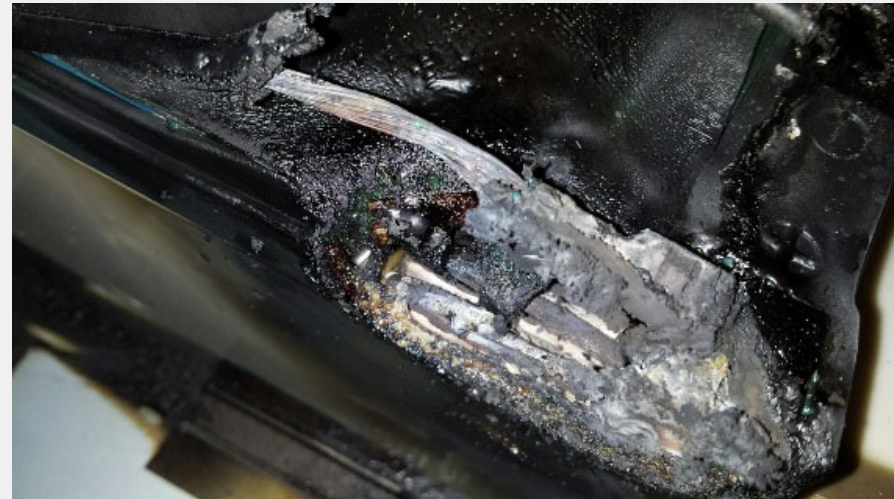

VRLA Battery Failure Modes: Summary

Thermal Runaway



Ripple Current

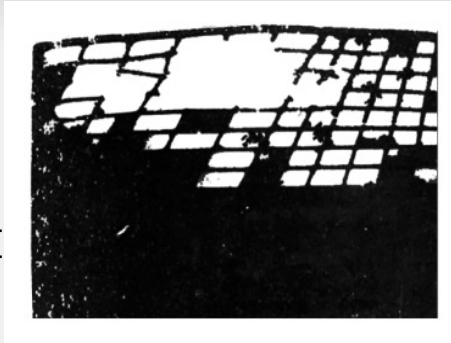

Storage

Sudden Death

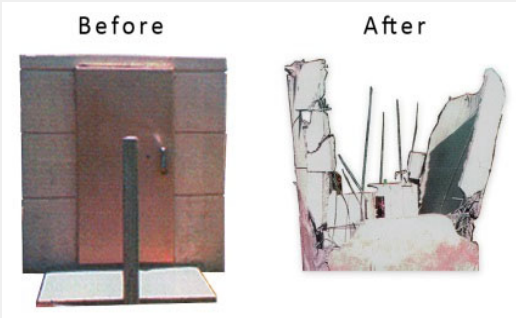

Dry Out

High Temperature



Corrosion



Sulfation

Nickel-Cadmium Basics

- Plates –
 - Substrate: Nickel-plated Steel
 - Positive Active Material: Nickel hydroxide
 - Negative Active Material: Cadmium
- Electrolyte = Potassium Hydroxide (KOH)
- PH = ~11
- Electrolyte is alkaline and **does not corrode the plates** or participate in the electrochemical reaction. It is actually a **preservative** of the plates.
- Nominal volts per cell ~1.2
- Failure Mode: **SHORT CIRCUIT**
- Different plate types: Pocket, Fiber, Sintered, Plastic Bonded (PBE)
- Total Reaction -

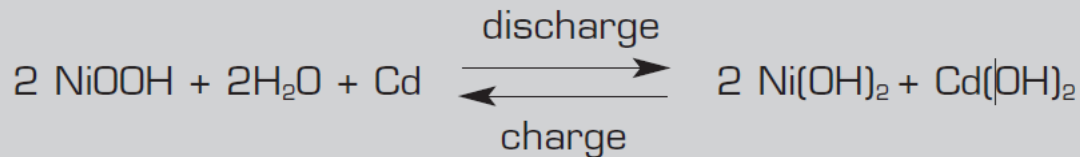

Nickel Cadmium Features

Advantages

- Most rugged battery type. All steel plate construction
- Resistant to: Electrical abuse, overcharging / over-discharging
- Physical abuse, extreme temperatures, shock & vibration
- Withstand temperature excursions from -40°C to +70°C
- Fast recharge with no adverse effects
- Impervious to ripple (a VRLA killer)
- Low maintenance
- Low total cost of ownership
- Design and service Life 25+ years

Disadvantages

- High initial cost compared with lead-acid
- Installed footprint can be larger than lead acid in some applications

Nickel Cadmium Pocket Plate (traditional design)

Single pocket

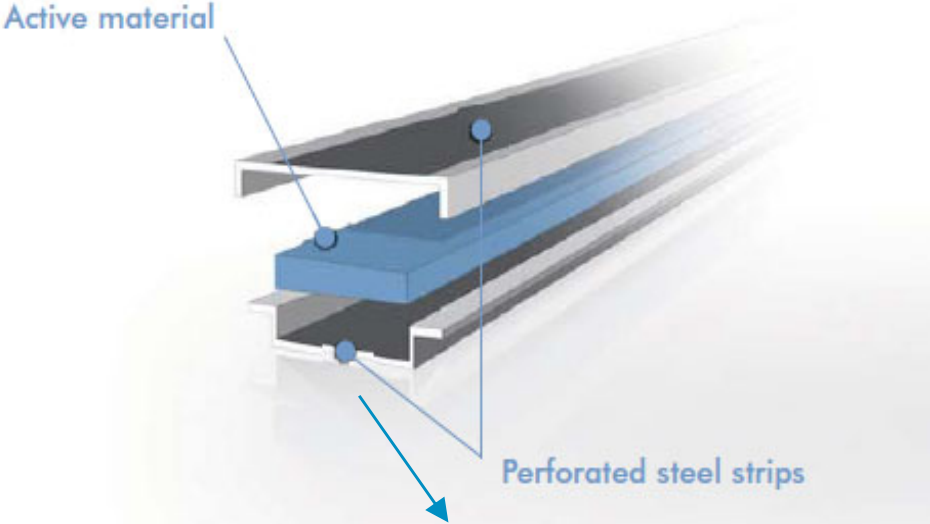

Pocket plate



Pocket stack

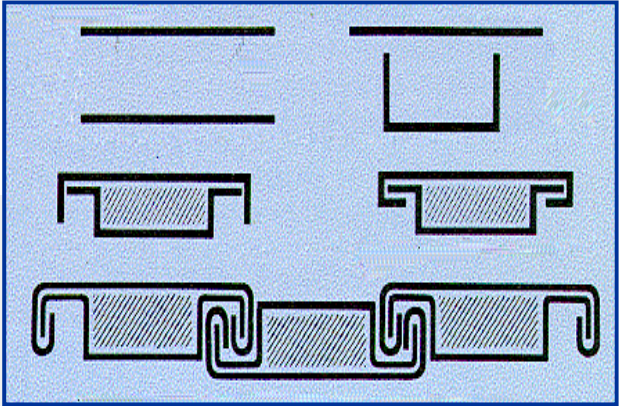

Protective cover

- to prevent external short-circuits
- in line with EN 50272-2 (safety) with IP2 level

Plate group bus

Connects the plate tabs with the terminal post. Plate tabs and terminal post are projection-welded to the plate group bus.

Separating grids

Separate the plates and insulate the plate frames from each other. The grids allow free circulation of electrolyte between the plates.

Cell container

Material: translucent polypropylene.

The cells are welded together to form rugged blocks of 1-6 cells depending on the cell size and type.

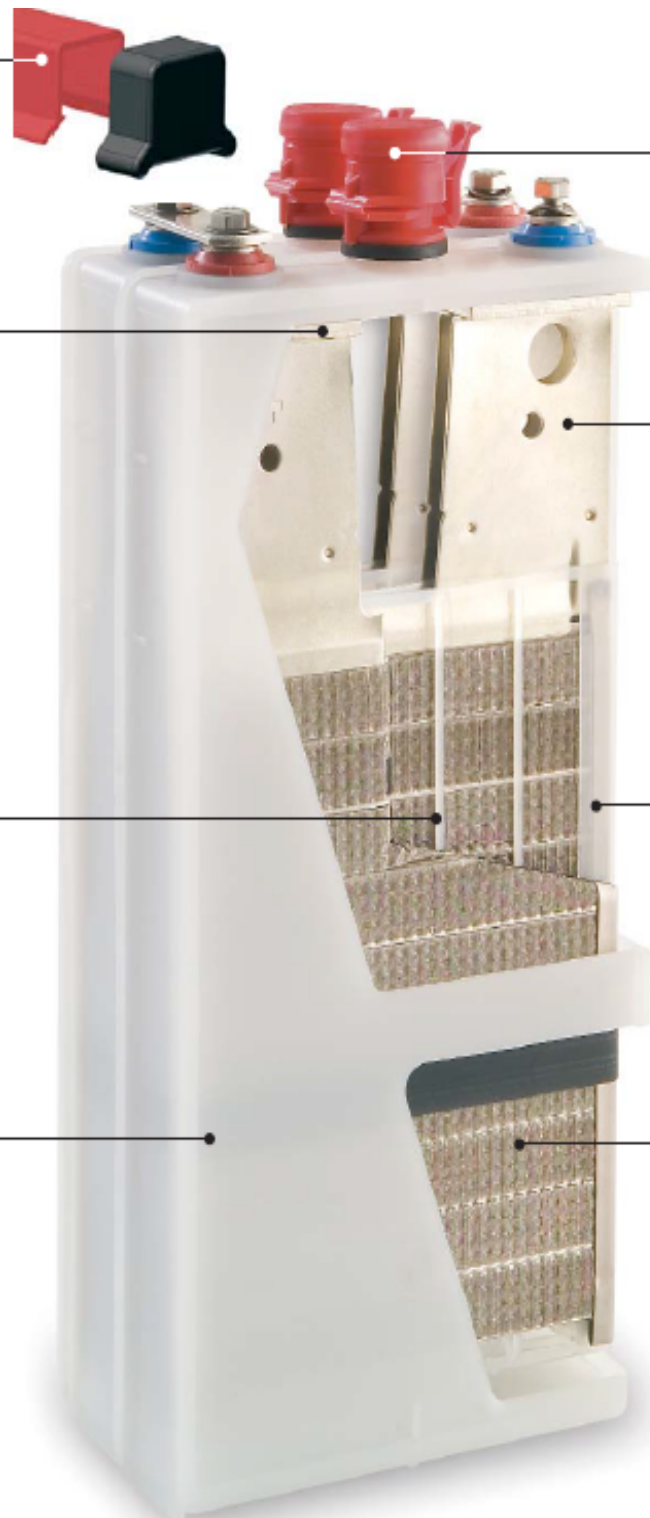

Flame-arresting vents
Material: polypropylene.

Plate tab
Spot-welded both to the plate side-frames and to the upper edge of the pocket plate.

Plate frame
Seals the plate pockets and serves as a current collector.

Plate
Horizontal pockets of double-perforated steel strips.

Saft cells fully comply and exceed the requirements of the IEC 60623 standard.

Maintenance Free (Recombinant) NiCd

Maintenance-free L and M types

- Qualified IEC 62259 for Ni-Cd with gas recombination (over 97%)
- Electrolyte is still liquid and abundant inside.

High tech maintenance-free concept

- Maintenance-free
 - No requirement to add any water throughout service life under recommended operations
 - Decrease the operational cost and reduce the maintenance manpower
 - Can be stored filled and charged up to 2 years



High Performance NiCad Batteries (S/PBE)

Sintered plate (Positive Plate)

Plastic Bonded Electrode (Negative Plate)

Highest Performance NiCad

- **High Energy Density**
- **High Power**
- **High charge acceptance at low voltage**

Ideal for Engine Starting and Switchgear Applications

Low Maintenance

- **10 – 13 Year topping up interval**

Single Cell / Compact Design

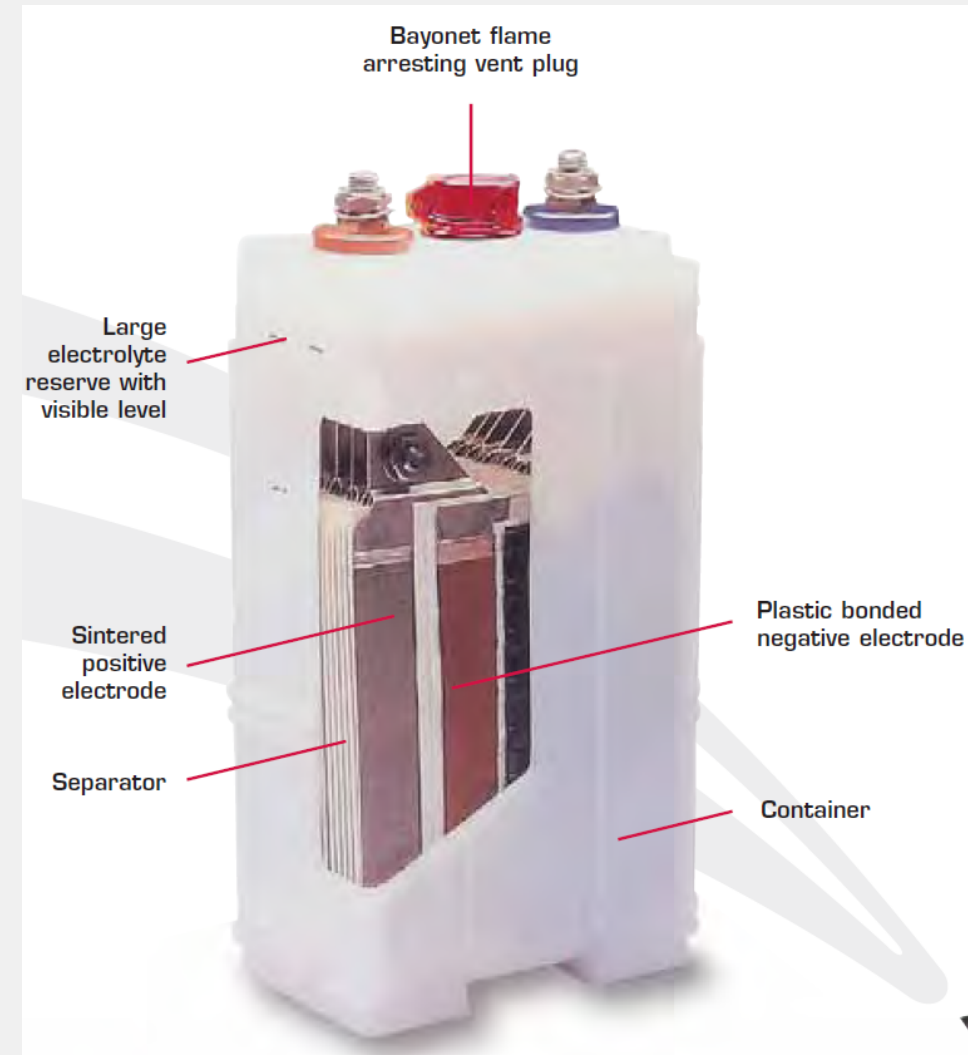

Sintered Plate Technology

Perforated & nickel plated steel strip

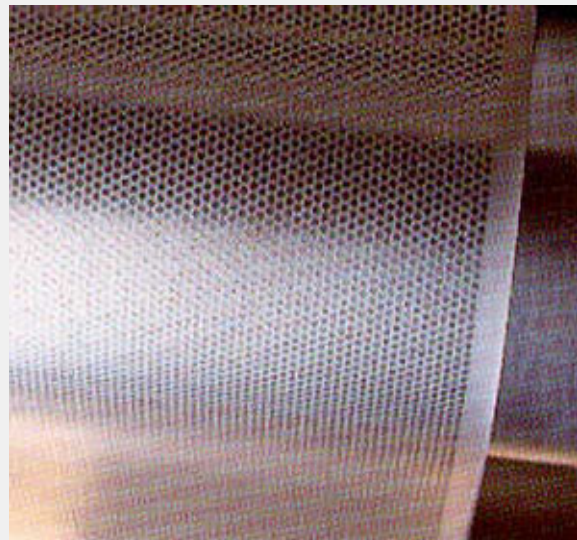

Electrochemical impregnation with active material



Nickel powder is sintered onto the strip to form a highly porous and conductive structure.



Plastic Bonded Plate Technology

Perforated & nickel plated steel strip

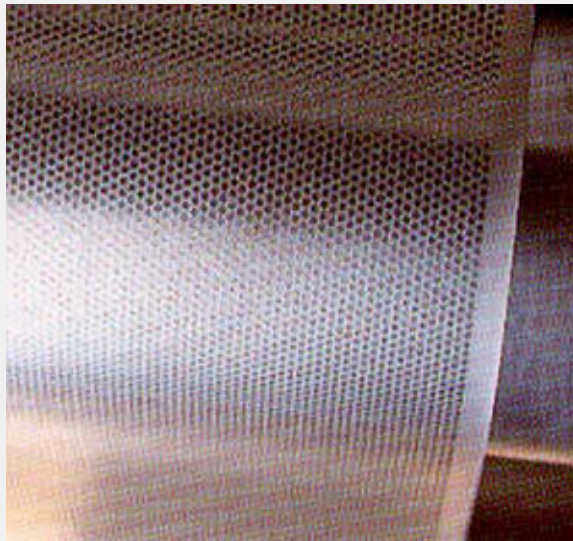

Pasting and drying of active material embedded into organic binder



saft

Intensium
Max

Li-ion

4

BATTERY COMPARISON

Technology Physical Comparison

What to look for:

Technologies being compared

- Nickel-Cadmium Vs Flooded Lead-Acid (VLA)

Sizing Results

Comparison parameters

- Footprint
- Volume
- Total weight (battery + racking)
- Price

Sizing Parameters

| Parameters | |
|--------------------|---------|
| Min. Voltage: | 105 Vdc |
| Max. Voltage: | 140 Vdc |
| Nom. Voltage: | 125 Vdc |
| Design Margin: | 1.15 |
| Aging Factor: | 1.25 |
| Temperature (max): | 30 °C |
| Temperature (min): | 15 °C |

| Load Profile | | |
|--------------|-------------|-----------------|
| <u>Step</u> | <u>Load</u> | <u>Duration</u> |
| 1: | 5 A | 8hr |
| 2: | 300 A | 1 min* |

**For Nickel-Cadmium the minimum performance step is 1 sec Vs. 1 min for Lead-Acid (Coup de Fouet). The "tripping load" can occur in under one second bursts.*

Sizing Results

| Nickel-Cadmium | | Vented Lead-Acid | |
|-------------------|-----------------|-------------------|-----------------|
| Nominal Capacity: | 130 Ah | Nominal Capacity: | 350Ah |
| Total WxDxH | 59" x 28" x 68" | Total WxDxH | 83" x 28" x 71" |
| Total Weight: | ~1,652 lbs | Total Weight: | ~4,461 lbs |
| Installed Energy: | 16.3 kWh | Installed Energy: | 43.8 kWh |

Footprint Comparison



| Technology | W (in) | D (in) | Area (in ²) |
|------------|--------|--------|-------------------------|
| Ni-Cd | 59 | 28 | 1,652 |
| VLA | 83 | 28 | 2,324 |

Volume Comparison

| Technology | W (in) | D (in) | H (in) |
|------------|--------|--------|--------|
| Ni-Cd | 59 | 28 | 68 |
| VLA | 83 | 28 | 71 |

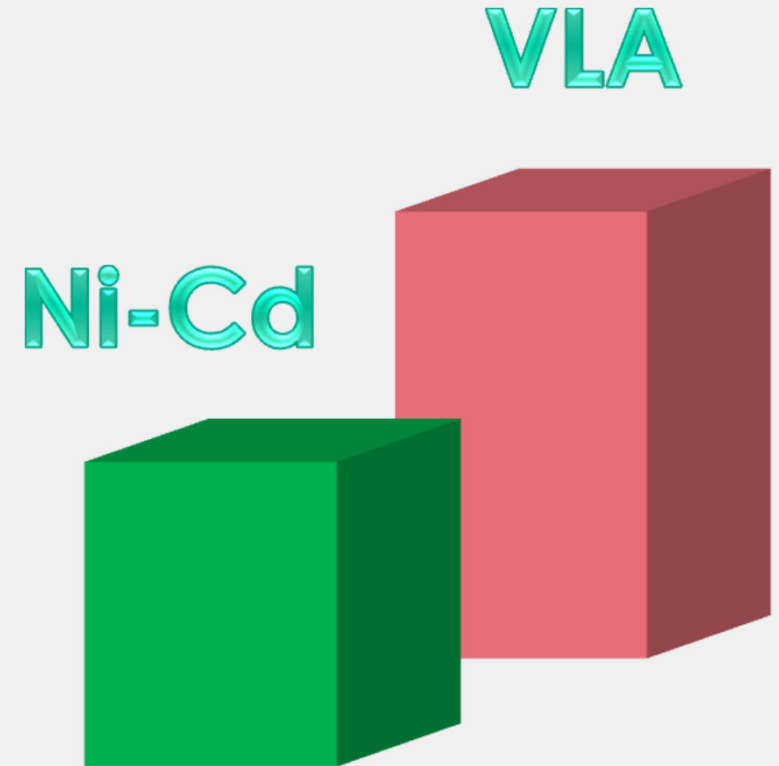

Total Weight Comparison



VLA

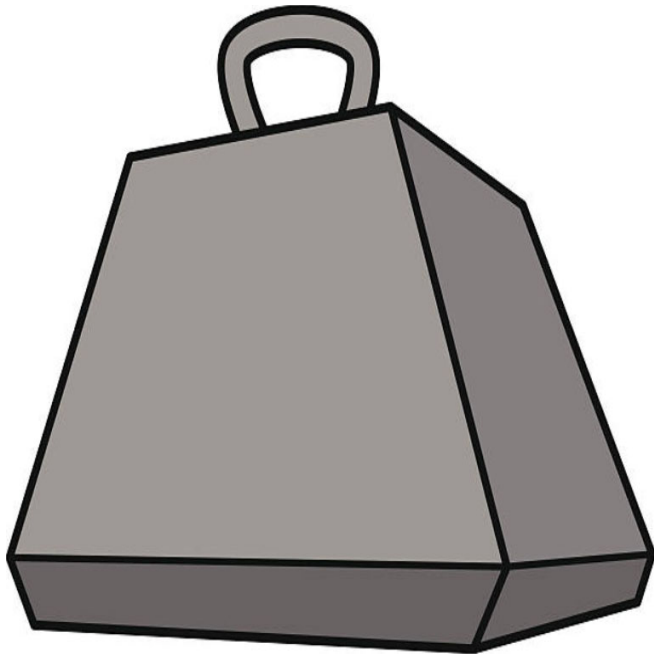

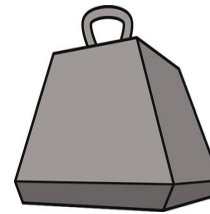

Ni-Cd



| Technology | Weight (lbs) |
|------------|--------------|
| Ni-Cd | 1,652 |
| VLA | 4,461 |

Price Comparison

| Technology | Initial Price | |
|------------|---------------|---|
| Ni-Cd | \$26k |  |
| VLA | \$14k |  |



5

CHOOSING THE RIGHT TECHNOLOGY

Considerations

- High Temperature
- Low Temperature
- Longer Life
- Low Maintenance
- Storage
- Space – Weight
- Vibration / Shock
- Cost of Failure

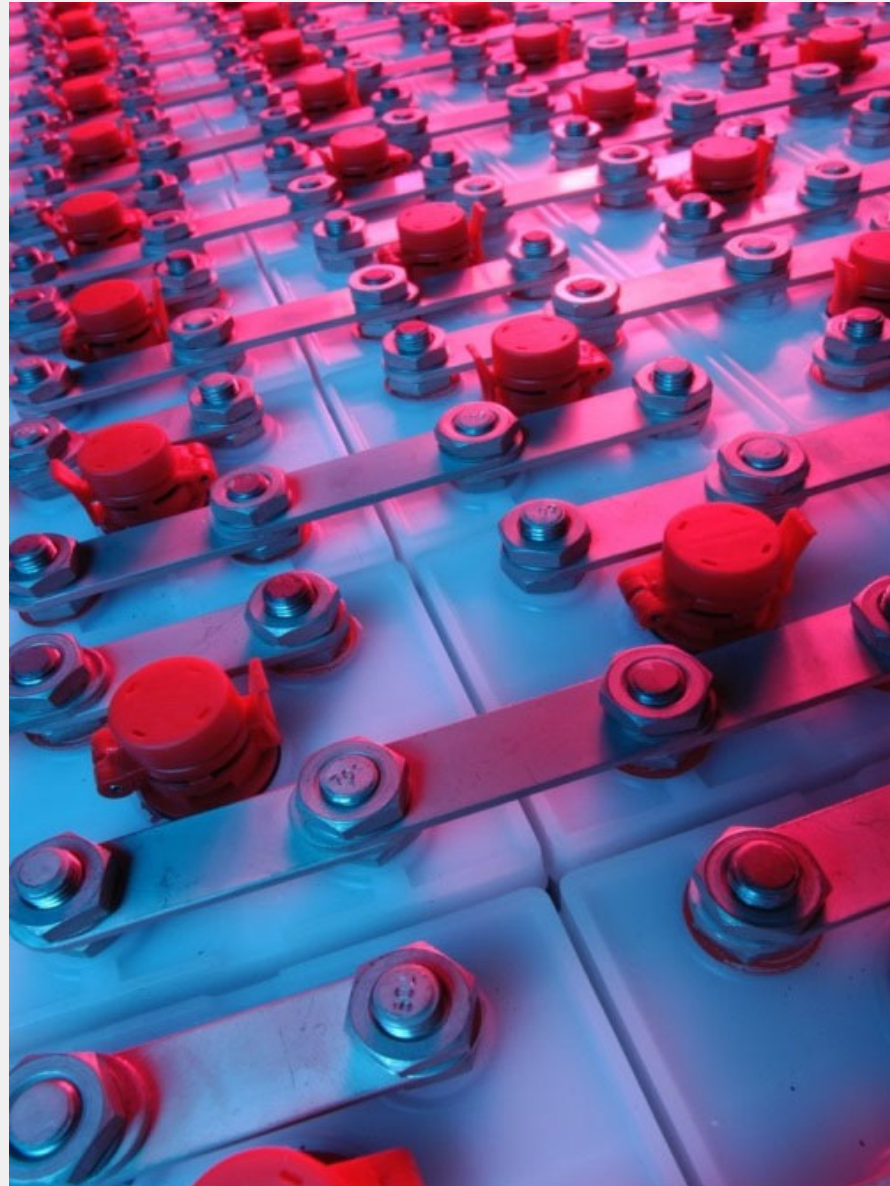

High Temperature – Shortens Life

Lead Acid

- Life is cut 50% for every 15°F over 77°F

Nickel Cadmium

- Life is cut 20% for every 15°F over 77°F

Normal Service Life

- VRLA 3 - 10 years
- Flooded Lead 12 – 15 years
- Ni-Cd 25+ years

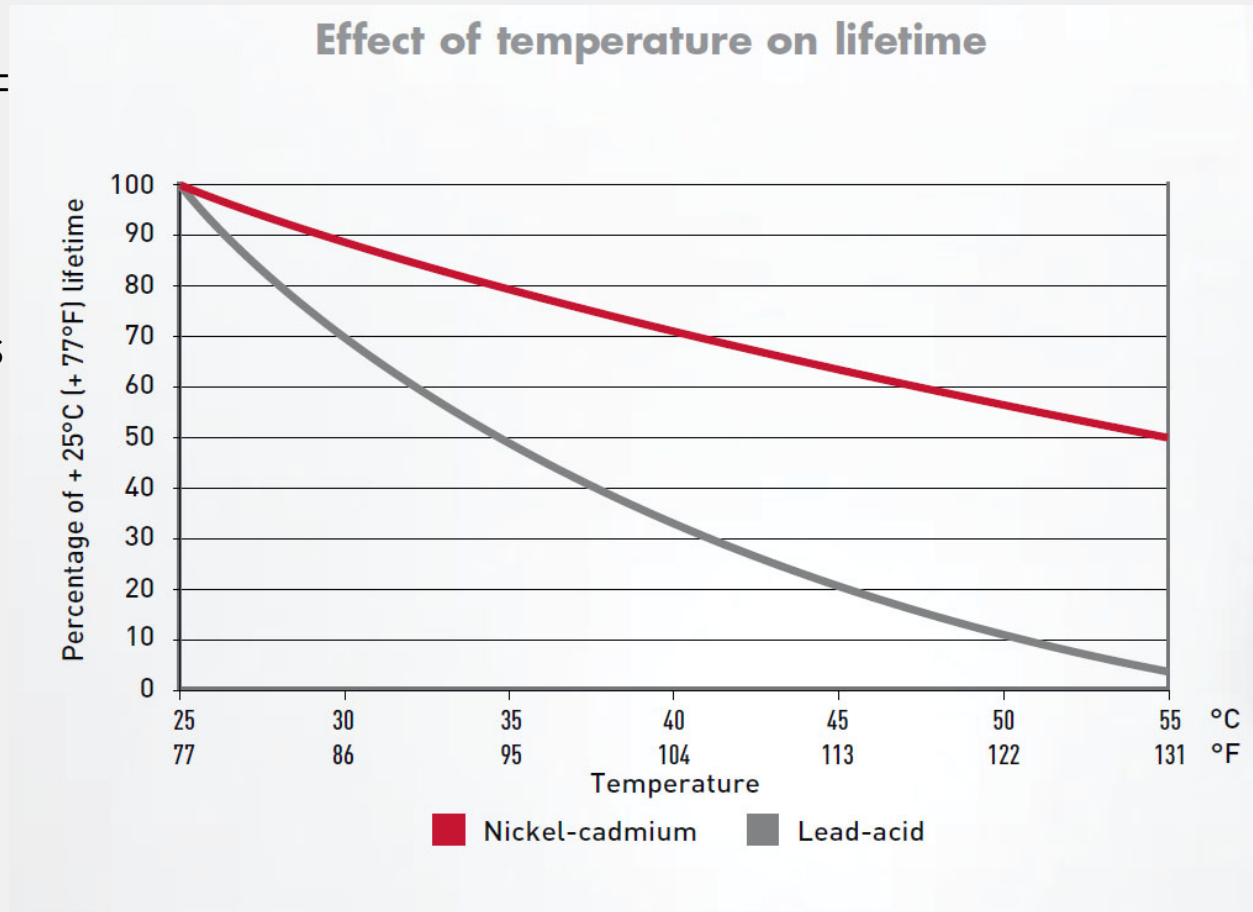

Low Temperature – Reduces Performance

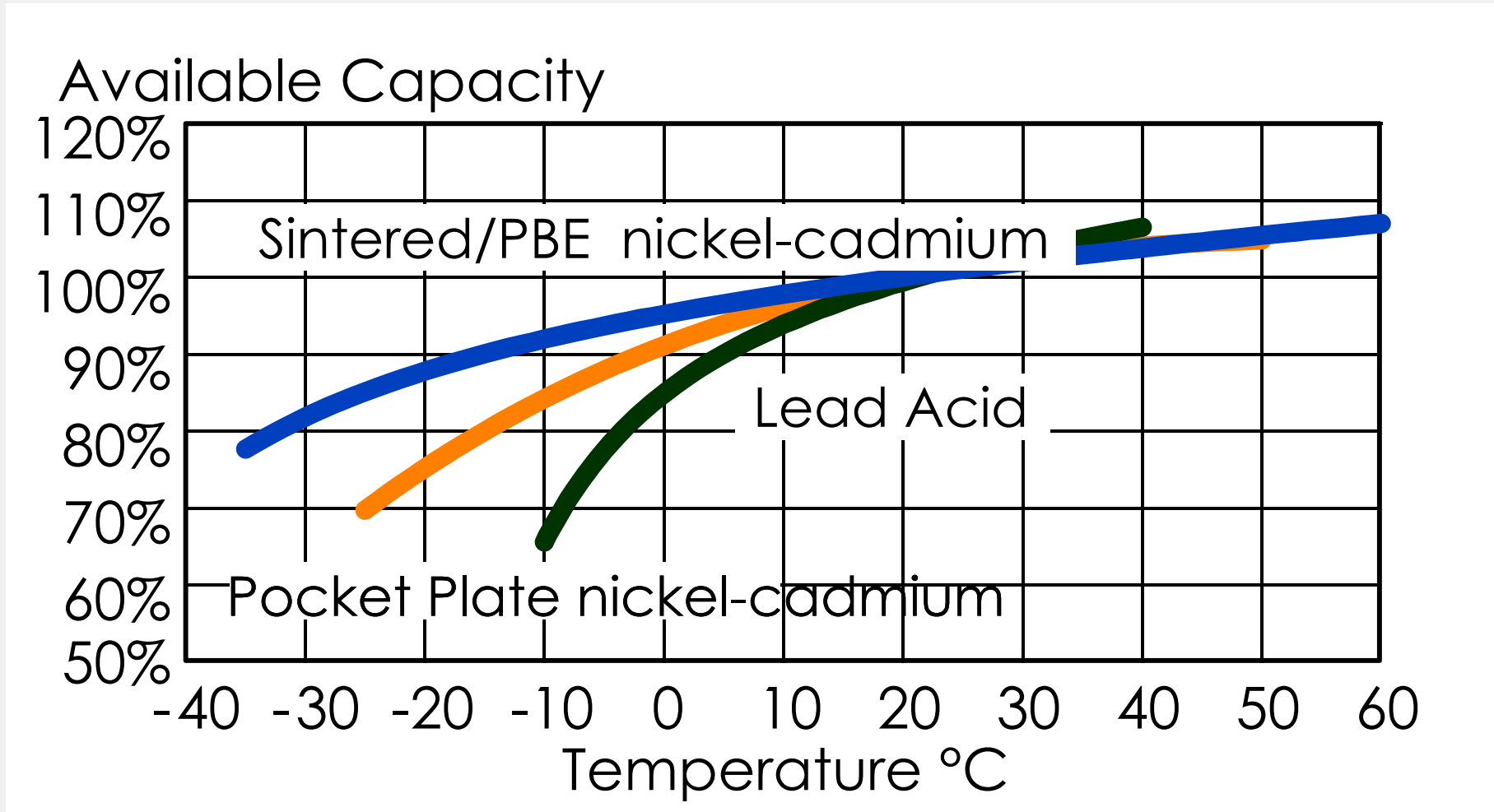

Nickel cadmium can operate to - 50C, no danger of freezing. Lead Acid can Freeze

Life Cycle Curve

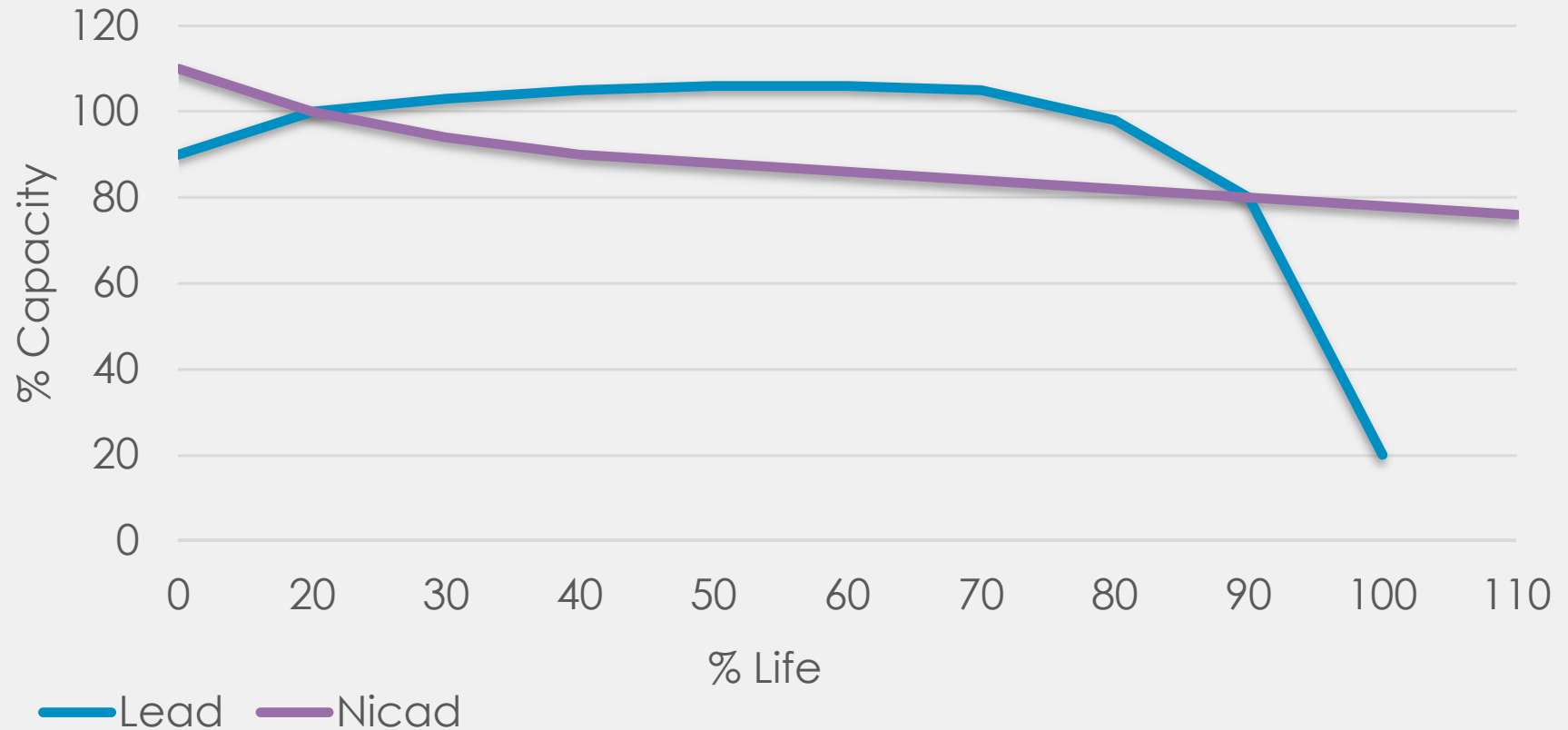

- **Ni-Cd cells lose about 1% capacity per year of life, they can continue service after 25 years with no catastrophic failure and will not fail in open circuit.**
- **When lead acid cells fail, they fail abruptly**
- **Graph shows ideal environment, maintenance and operating parameters.**

Maintenance

Why is it important?

- Secure and protect the battery investment
- Required for some applications (NERC/FERC)
- Predict failures
- Easy warranty claims

Must consider:

- Total cost of ownership
- Site location and accessibility

| Maintenance Procedures | IEEE 450 Lead Acid | IEEE 1188 VRLA | IEEE 1106 Nickel Cadmium |
|--------------------------------|---------------------------|------------------------|---------------------------------|
| Visual inspection | Monthly | Monthly | Quarterly |
| Pilot cell reading | Monthly | Monthly | Quarterly |
| Float voltage – battery | Monthly | Monthly | Quarterly |
| Float voltage – cells | Quarterly | Semi-annually | Semi-annually |
| Watering | 3-6 Months | Never / replace | 1.8 – 20 Years |

Storage

How often do you hear, “The site is not ready.”

- Once filled, Lead Acid needs refreshing charge every 3-6 months
- Nickel Cadmium Pocket Plate (SBLE/SBM/SBH) can be stored for 6 months to 1 year (filled and charged) or many years dry and discharged.
- Sintered Plastic Bonded Electrode (SPH) Cells can be stored discharged for many years.
- Uptimax are supplied filled and charged and can be stored for 2 years in this condition.
- **Consider the battery's DATE CODE!**
- **On-site commissioning is recommended for all batteries**



Cost of failure

- Battery cost in relation to protected equipment cost is negligible.
- **Loss of power could result in loss of thousands to millions of dollars or even loss of life.**
- Lead Batteries even when monitored and maintained can be unpredictable as to when they will fail. **Lead cells usually fail as an open circuit. One lead-acid cell failure will take out whole battery.**
- Nickel Cadmium have very gradual capacity loss. **Ni-Cd cells fail as a short circuit. The battery will still function with loss of several cells.**

Further References

- IEEE1106 – Recommended practice for Installation, Maintenance, Testing, and replacement of Vented Nickel-Cadmium Batteries
- IEEE1115- Recommended Practice for Sizing Nickel-Cadmium batteries for stationary applications
- IEEE 450 – Recommended practice for Maintenance, Testing and replacement of Vented Lead-Acid Batteries
- IEEE484 – Recommended practice for Installation of Vented Lead-Acid batteries
- IEEE485 – Recommended Practice for Sizing Lead-Acid batteries for stationary applications
- IEEE1188 - Recommended practice for Installation, Maintenance, Testing, and replacement of Valve Regulated Lead-Acid Batteries

Additional Saft Resources

Lunch and Learns

- Battery Sizing and Selection
- Advanced Nickel Cadmium Concepts
- Advanced Lithium-Ion Concepts
- Battery Chargers and other DC System Components

Guide Specifications for Consultants

Factory Battery Maintenance Training

Thank You . . . Questions??